

# Sigfox Repeater

## Expand sigfox network coverage

---

Guide utilisateur / User Guide

Version 3.0.0



## Préambule / Preamble / Präambel / Preambolo / Preámbulo

- Ce guide décrit les fonctionnalités du produit adeunis®. Il explique les modes de fonctionnement du produit et la manière de le configurer.
- This guide describes the functionalities of the product adeunis®. It explains its functionnements and how to configure it.
- Dieser Leitfaden beschreibt die Funktionalität des Produktes adeunis®. Er erklärt die Betriebsfunktionen des Produktes und die Art und Weise, um es zu konfigurieren.
- Questa guida descrive la funzionalità del prodotto adeunis®. Questo spiega come funziona il prodotto e come configurarlo.
- Esta guía describe las funcionalidades del producto adeunis®. En él se explica los modos de funcionamiento del producto y cómo configurarlo.
  
- Aucun extrait de ce document ne pourra être reproduit ou transmis (sous format électronique ou papier, ou par photocopie) sans l'accord d'adeunis®. Ce document pourra être modifié sans préavis. Toutes les marques citées dans ce guide font l'objet d'un droit de propriété intellectuelle.
- No part of this document may be reproduced or transmitted (in electronic or paper, or photocopying) without the agreement adeunis®. This document may be changed without notice. All trademarks mentioned in this guide are the subject of intellectual property rights. adeunis®.
- Kein Teil dieses Dokuments darf reproduziert oder übertragen werden (in elektronischer oder Papierform oder Fotokopie) ohne die Zustimmung adeunis®. Dieses Dokument darf ohne vorherige Ankündigung geändert werden. Alle Marken in diesem Handbuch erwähnt werden, sind Gegenstand des geistigen Eigentums.
- Nessuna parte di questo documento può essere riprodotta o trasmessa (in fotocopia elettronica o cartacea, o), senza il consenso adeunis®. Questo documento può essere modificato senza preavviso. Tutti i marchi citati in questa guida sono oggetto di diritti di proprietà intellettuale.
- Ninguna parte de este documento puede ser reproducida o transmitida (en fotocopias electrónico o en papel, o) sin el acuerdo adeunis®. Este documento puede ser modificada sin previo aviso. Todas las marcas comerciales mencionadas en esta guía son el tema de los derechos de propiedad intelectual.

**Adeunis**  
**283, rue Louis Néel**  
**38920 Crolles**  
**France**

**Web** [www.adeunis.com](http://www.adeunis.com)

Table des matières/Table of contents

<b>ENGLISH</b>	<b>5</b>
PRODUCTS AND REGULATORY INFORMATION	6
<b>1. PRODUCT DESCRIPTION</b>	<b>11</b>
1.1. General description	11
1.2. Dimensions	12
1.3. Electronic card	12
1.4. Technical specifications	13
1.4.1 General characteristics	13
1.4.2 Autonomy	13
1.5. User interface	13
1.5.1 USB Port	13
1.5.2 LED	14
1.6. Mobile application	14
<b>2. ACTIVATION PROCESS AND CONFIGURATION</b>	<b>15</b>
2.1. Configure the White List	15
2.2. Activating the repeater	16
2.3. Configuration mode	16
2.3.1 Configuration through the Repeater Application	16
2.3.1.01 Connection	17
2.3.1.02 Radio mapping (Optional)	18
2.3.1.03 Setup	19
1.1.1.01 White list edition	23
1.1.1.02 Advanced - Expert view: Duty Cycle check disable/re-enable	23
2.3.1.04 Advanced - Expert view: Statistics access	24
2.4. Operation mode	25
2.4.1 Installation mode	26
2.4.2 Repeater monitoring with the sigfox backend	27
<b>3. DEVICE CONFIGURATION WITH AT COMMANDS</b>	<b>31</b>
3.1. Connecting the device to a computer	31
3.2. Command mode	31
3.3. Configuration through a terminal and AT Commands	33
3.4. Description of the registers	34
<b>4. DESCRIPTION OF THE REPEATER FRAMES</b>	<b>36</b>
4.1. Uplink frame	36
4.1.1 Fixed bytes	36
4.1.1.01 Byte code	36
4.1.1.02 Status Byte	36
4.1.2 Ask for a new ID in the White List	36
4.1.3 Ask for White List modification or configuration modification	36
4.1.4 Reporting of downlink success or failure	37
4.1.5 White List confirmation	37
4.1.6 Summary of the conditions of transmission of uplink frames	38
4.2. Downlink frames	38
4.2.1 Suppress all IDs from the White List and switch repeater into PARK, INSTALLATION or OPERATION mode	38
4.2.2 Delete an ID from the White List	39
4.2.3 Add an ID into the White List or confirm White-List	39
4.2.4 Modify the Repeater configuration	39
4.2.5 Freeze the list of devices repeated in "auto-record" mode into the White List	40
4.2.6 Downlink success or error code	40
<b>5. BATTERY REPLACEMENT AND START-UP OF THE DEVICE</b>	<b>41</b>
5.1. Battery replacement	41
5.2. Closing the casing	42
5.3. Starting up the product using a magnet	42
<b>6. INSTALLATION AND USE</b>	<b>43</b>
6.1. Correct positioning of the product	43
6.2. Types of fastenings	43
6.2.1 Tube or mast fastenings	43
6.2.2 Fixing with screws	44
6.2.3 DIN-Rail fixing	45
<b>7. DOCUMENT HISTORY</b>	<b>45</b>

<b>FRANCAIS</b>	<b>46</b>
INFORMATIONS	47
<b>DEUTSCH</b>	<b>52</b>
Vorschriften	52

EN

# ENGLISH

## PRODUCTS AND REGULATORY INFORMATION

Document Information	
<b>Title</b>	Sigfox Repeater - User Guide
<b>Sub-title</b>	/
<b>Document type</b>	User Guide
<b>Version</b>	3.0.0

This document applies to the following products :

Nom	Référence	Version firmware
Sigfox Repeater RC1	ARF8168	V2.03.05

## DISCLAIMER

This document and the use of any information contained therein, is subject to the acceptance of the adeunis® terms and conditions. They can be downloaded from [www.adeunis.com](http://www.adeunis.com).

adeunis® makes no warranties based on the accuracy or completeness of the contents of this document and reserves the right to make changes to specifications and product descriptions at any time without notice.

adeunis® reserves all rights to this document and the information contained herein. Reproduction, use or disclosure to third parties without express permission is strictly prohibited. Copyright © 2016, adeunis®.

adeunis® is a registered trademark in the EU and other countries.

## TECHNICAL SUPPORT

### Website

Our website contains a lot of useful information: information on modules and wireless modems, user guides, and configuration software and technical documents which can be accessed 24 hours a day.

### E-mail

If you have technical problems or cannot find the required information in the provided documents, contact our Technical Support on our website, section « Technical Support ». This ensures that your request will be processed as soon as possible.

### Helpful Information when Contacting Technical Support

When contacting Technical Support, please have the following information ready:

- Product type
- Firmware version (for example V1.0)
- A clear description of your question or the problem
- A short description of the application

# EU Declaration of Conformity

**WE**

adeunis  
 283 rue LOUIS NEEL  
 38920 Crolles, France  
 04.76.92.01.62  
 www.adeunis.com

EN

**Declare that the DoC is issued under our sole responsibility and belongs to the following product:**

Apparatus model/Product: Repeater  
 Type: ARF8168A

**Object of the declaration:**

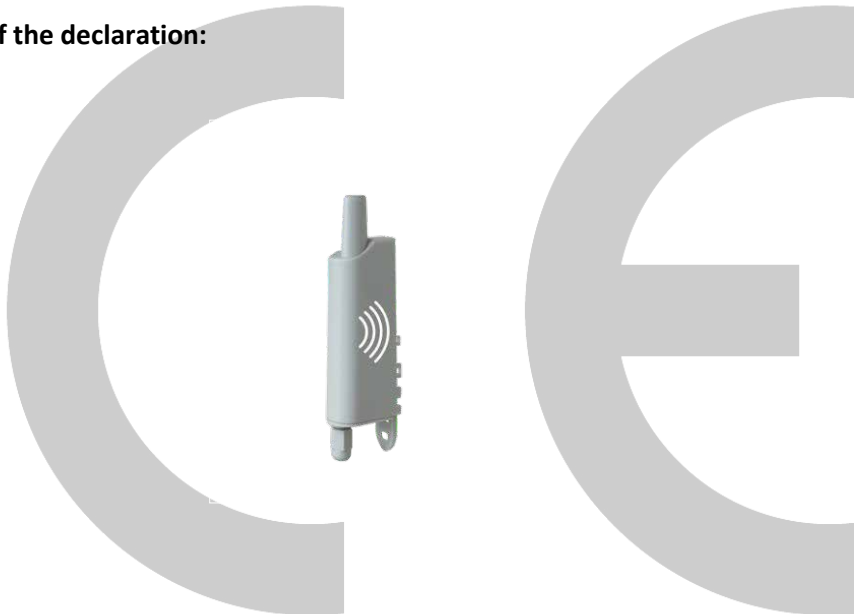

The object of the declaration described above is in conformity with the relevant Union harmonisation legislation:

**Directive 2014/53/UE (RED)**

**The following harmonised standards and technical specifications have been applied:**

Title:	Date of standard/specification
EN 300 220-2 V3.1.1	2017/02
EN 301 489-1 V2.1.1	2016/11
EN 301 489-3 V2.1.0	2016/09
EN 62368-1	2014
EN 62311	2008

December, 18<sup>th</sup>, 2017

Monnet Emmanuel, Certification Manager



## INTRODUCTION

All rights to this manual are the exclusive property of adeunis®. All rights reserved. Copying this manual (without written permission from the owner) via printing, copying, recording or by any other means, translating this manual (in full or partially) into any other language, including all programming languages, using any electrical, mechanical, magnetic or optical devices, manually or any by other methods, is prohibited.

adeunis® reserves the right to change the technical specifications or functions of its products, or to cease manufacturing any of its products, or to cease technical support for one of its products without notice in writing and urges its customers to make sure that the information they have is valid.

adeunis® configuration software and programs are available free of charge in a non-modifiable version. adeunis® can make no guarantees, including guarantees concerning suitability and applicability for a certain type of application. Under no circumstances can the manufacturer, or the distributor of an adeunis® program, be held liable for any damage caused by the use of the aforesaid program. Program names, as well as all copyright relating to programs, are the exclusive property of adeunis®. Any transfer, granting of licences to a third party, leasing, hire, transport, copying, editing, translation, modification into another programming language or reverse engineering are prohibited without adeunis®'s prior written authorisation and consent.

### **Adeunis**

283, rue Louis Néel  
38920 Crolles  
France

**Web** [www.adeunis.com](http://www.adeunis.com)

EN



## ENVIRONMENTAL RECOMMENDATIONS

All superfluous packaging materials have been eliminated. We have done everything possible to make it easy to separate the packaging into three types of materials: cardboard (box), expanded polystyrene (filler material) and polyethylene (packets, foam protective sheets). Your device is composed of materials that can be recycled and reused if it is dismantled by a specialist company. Please observe local regulations concerning the manner in which waste packaging material, used batteries and your obsolete equipment are disposed of.

## WARNINGS

Valid for products indicated in the declaration of conformity



Read the instructions in the manual.



The safety of this product is only guaranteed when it is used in accordance with its purpose. Maintenance should only be carried out by qualified persons.



Risk of explosion if the battery is removed with an incorrect type. Contact Adeunis for more information if needed.



Risk of explosion if the battery is replaced by an incorrect type

**Please note:** Do not install the equipment close to a heat source or in damp conditions.

**Please note:** When the equipment is open, do not carry out any operations other than the ones set out in this document.



Please note: Do not open the product as there is a risk of electrical shock.



Please note: For your own safety, you must ensure that the equipment is switched off before carrying out any work on it.



Please note: For your own safety, the power supply circuit must be SELV (Safety Extra Low Voltage) and must be from limited power sources.

Please note: When the aerial is installed outside, it is essential to connect the cable screen to the building's earth. We recommend using lightning protection. The protection kit chosen must permit the coaxial cable to be earthed (eg: coaxial lightning arrester with earthing of the cable at different places on the aerial at the base of pylons and at the entrance, or just before entering the premises).

The product must be equipped with a switching mechanism so that the power can be cut. This must be close to the equipment. Any electrical connection of the product must be equipped with a protection device against voltage spikes and short-circuits.

## RECOMMENDATIONS REGARDING USE

- Before using the system, check that the power supply voltage shown in the user manual corresponds to your supply. If it doesn't, please consult your supplier.
- Place the device against a flat, firm and stable surface.
- The device must be installed in a location that is sufficiently ventilated so that there is no risk of internal heating and it must not be covered with objects such as newspapers, cloths, curtains, etc.
- The device's aerial must be free and at least 10 cm away from any conducting material.
- The device must never be exposed to heat sources such as heating equipment.
- Do not place the device close to objects with naked flames such as lit candles, blowtorches, etc.
- The device must not be exposed to harsh chemical agents or solvents likely to damage the plastic or corrode the metal parts.

## DISPOSAL OF WASTE BY USERS IN PRIVATE HOUSEHOLDS WITHIN THE EUROPEAN UNION



This symbol on the product or on its packaging indicates that this product must not be disposed of with your other household waste. Instead, it is your responsibility to dispose of your waste by taking it to a collection point designated for the recycling of electrical and electronic appliances. Separate collection and recycling of your waste at the time of disposal will contribute to conserving natural resources and guarantee recycling that respects the environment and human health. For further information concerning your nearest recycling centre, please contact your nearest local authority/town hall offices, your household waste collection company or the shop where you bought the product



This symbol on the device or its packaging means the use of a DC voltage.



Warning: If the charger is used with any other batteries or products whatsoever, there is a risk of an explosion. After use, the batteries must be disposed of at an appropriate recycling centre. They must not be thrown away to degrade in the environment. When batteries are replaced, the device must be correctly implemented.



Warning for Switzerland : the annex 4.10 of SR 814.013 Standard must be applied for batteries.

## 1. PRODUCT DESCRIPTION

**IMPORTANT NOTE:** the Sigfox Repeater can be started or restarted using a magnet. **The Sigfox Repeater must be declared on the Sigfox network to be used.**

### Description:

- The Sigfox Repeater is a ready to use radio transmitter allowing to expand sigfox network coverage
- This product meets the needs of users who require to connect any sigfox products in areas with few network coverage.
- Like other Sigfox devices the Sigfox Repeater has to be declared on the Sigfox back-end.
- The Sigfox Repeater is an uplink service message repetitions for devices, the repeater can not repeat downlink address to devices.
- It allows to define a list of products to be repeated (White List) that can be configured in different way.
- A facilitated implementation procedure is available.
- The Sigfox Repeater is powered by a replaceable internal battery.

EN

### 1.1. General description

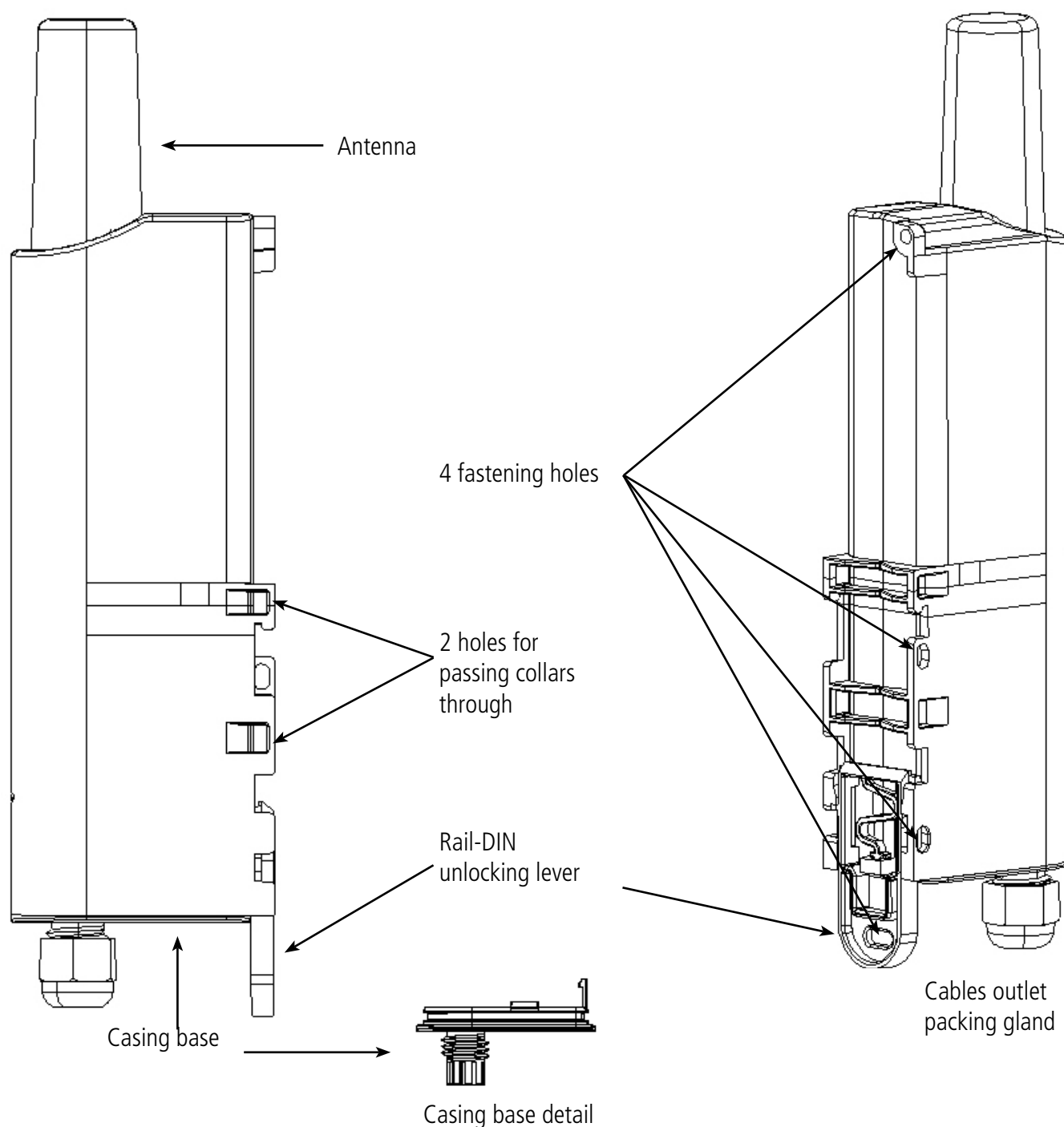

## 1.2. Dimensions

Values in millimetres

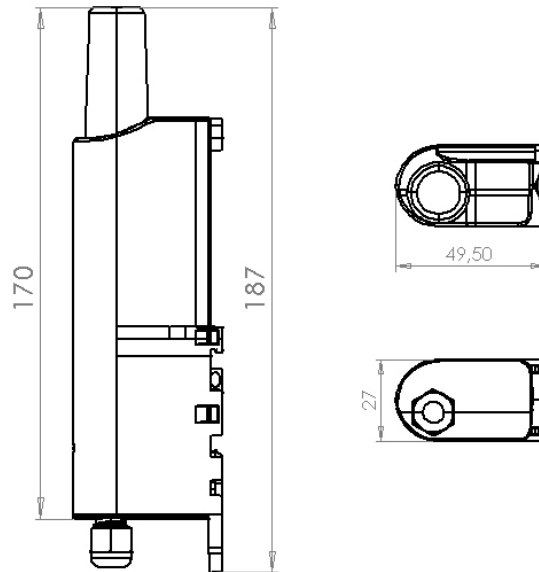

## 1.3. Electronic board

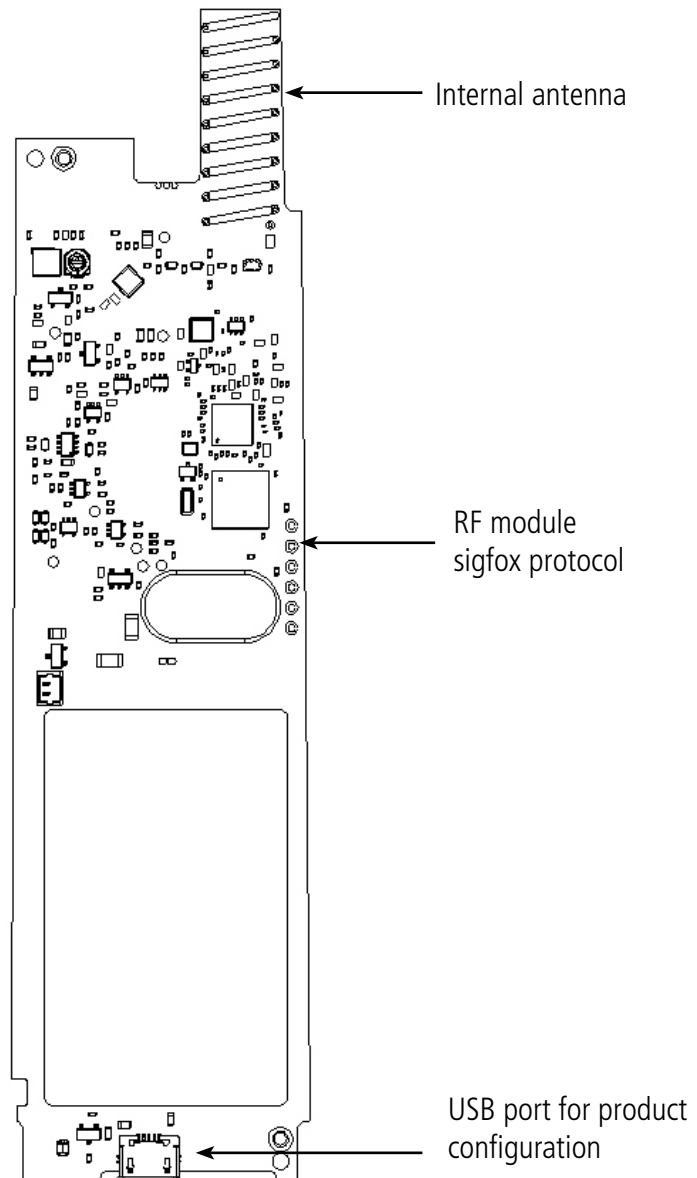

## 1.4. Technical specifications

### 1.4.1 General characteristics

Settings	Value
Supply voltage	3.6V nominal
Power supply	Battery pack Li-SOCI2 (non-rechargeable)
Working temperature	-20°C / +60°C
Dimensions	185 x 50 x 27mm
Weight	135g
Casing	IP 67
sigfox zone	RC1
Range	Up to 300m in outdoor and 50m in indoor

### 1.4.2 Autonomy

Use case	Nb of devices	Total number of messages to repeat (per day)	Estimated battery life (1 repetition)	Estimated battery life (3 repetitions)
Best case : 1 device which transmits 1 message /day	1	1	7 years	7 years
5 devices, each transmitting 2 messages /day	5	10	6 years	5 years
15 devices, each transmitting 5 messages /day	15	75	3,5 years	1,5 years
Worst case : 140 messages /day	N/A	140	2 years	1 year

The above values are estimations based on certain conditions of use and environment. This estimation takes into account 100 sigfox unwanted messages. They do not represent a commitment on the part of adeunis®.

## 1.5. User interface

The repeater has two elements that serve as a user interface : a LED and an USB port

### 1.5.1 USB Port

The USB port is a micro-usb (similar to what is used in most of today's smartphones). It is solely used for device configuration and has no other purpose. See section « 5. DEVICE CONFIGURATION ».

**IMPORTANT NOTE:** When the USB is plugged in, the device is still powered by the battery pack. Since the USB connection draws a non-negligible amount of power, make sure that you disconnect the USB cable once the configuration is finished (do not leave it on your desk with the USB plugged in)

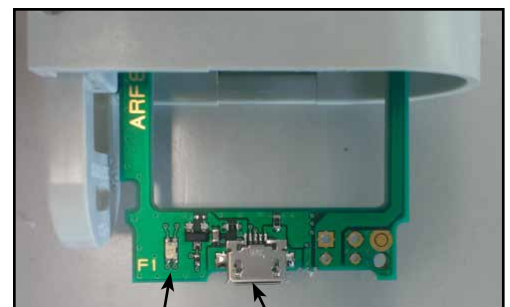

LED

USB port for product configuration

## 1.5.2 LED

The LED is used at many different stages of the product's operating life. The following table describes the LED behavior in those different cases. More details are provided in section 3.

Mode	Red led state	Green led state
PARK	OFF	OFF
Magnet detection	ON as soon as magnet is detected	ON for 1s when magnet detection has been validated
INSTALL	Blink 500ms	Blink 500ms
CONFIG	ON	ON
OPERATION : sync detection	ON until end of frame	OFF
OPERATION : repetition	OFF	1x ON per repetition
OPERATION : send OOB	OFF	1x ON per repetition
OPERATION : duty cycle problem (impossible to send frame)	Blink (100 ms ON /100ms OFF) x3	OFF

The LED can be used to monitor the repeater's state of operation :

### 1.5.2.01 SIGFOX message is detected

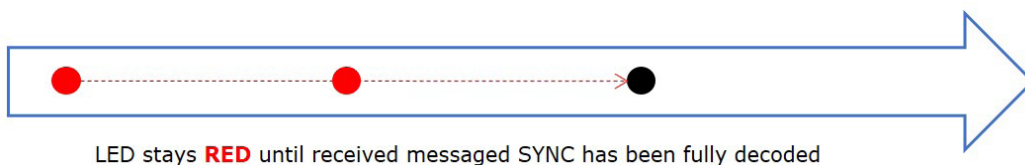

### 1.5.2.01 SIGFOX message repetition can be discarded due to duty cycle limitation

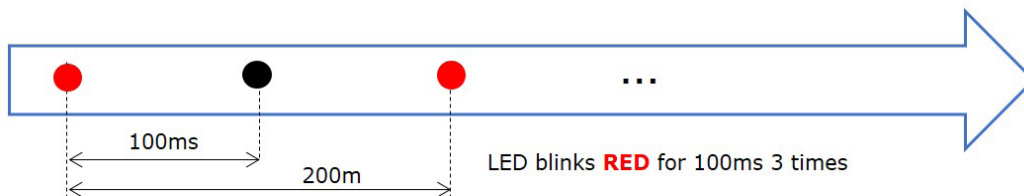

### 1.5.2.01 SIGFOX message is transmitted

This can either be:

- a. A repetition
- b. A status frame

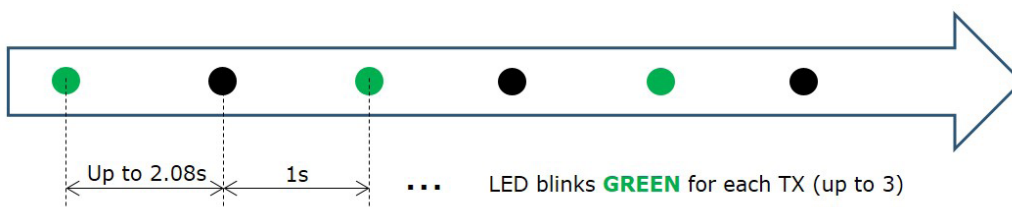

**1.5.2.01 Low BAT : the battery is low and should be changed, but the device is still operating**

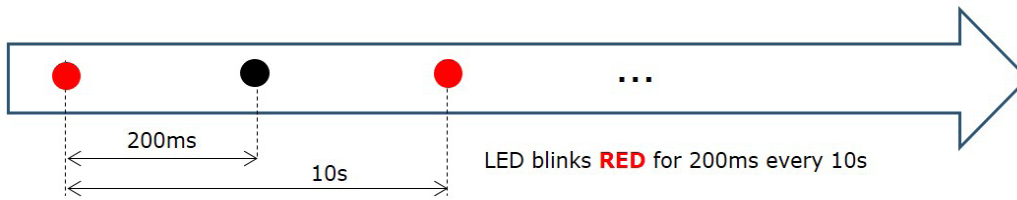

**1.5.2.01 DEAD : the battery is dead. The repeater stops all activity except warning LED**

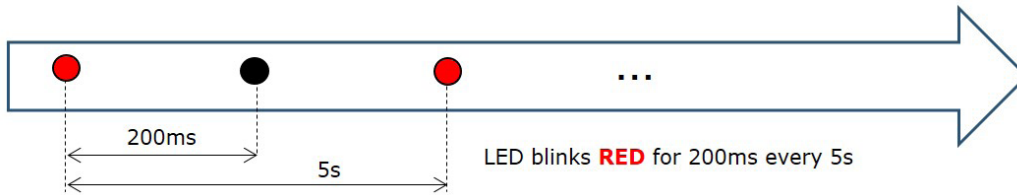

EN

**1.6. Mobile application**

A mobile application is available on the Google store, named «adeunis sigfox Repeater App», and for Windows on our website. This application allows you to configure a repeater but also to manage its environment and the topology.



<https://play.google.com/store/apps/details?id=com.adeunis.RepeaterApp>

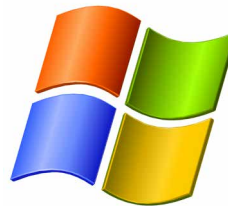

<https://www.adeunis.com/en/produit/repeteur-2/>

**IMPORTANT NOTE:** the mobile application need the OTG feature on your smartphone, please check by downloading a dedicated app like « USB OTG Checker » for example.

## 2. ACTIVATION PROCESS AND CONFIGURATION

The product has 6 states of operation:

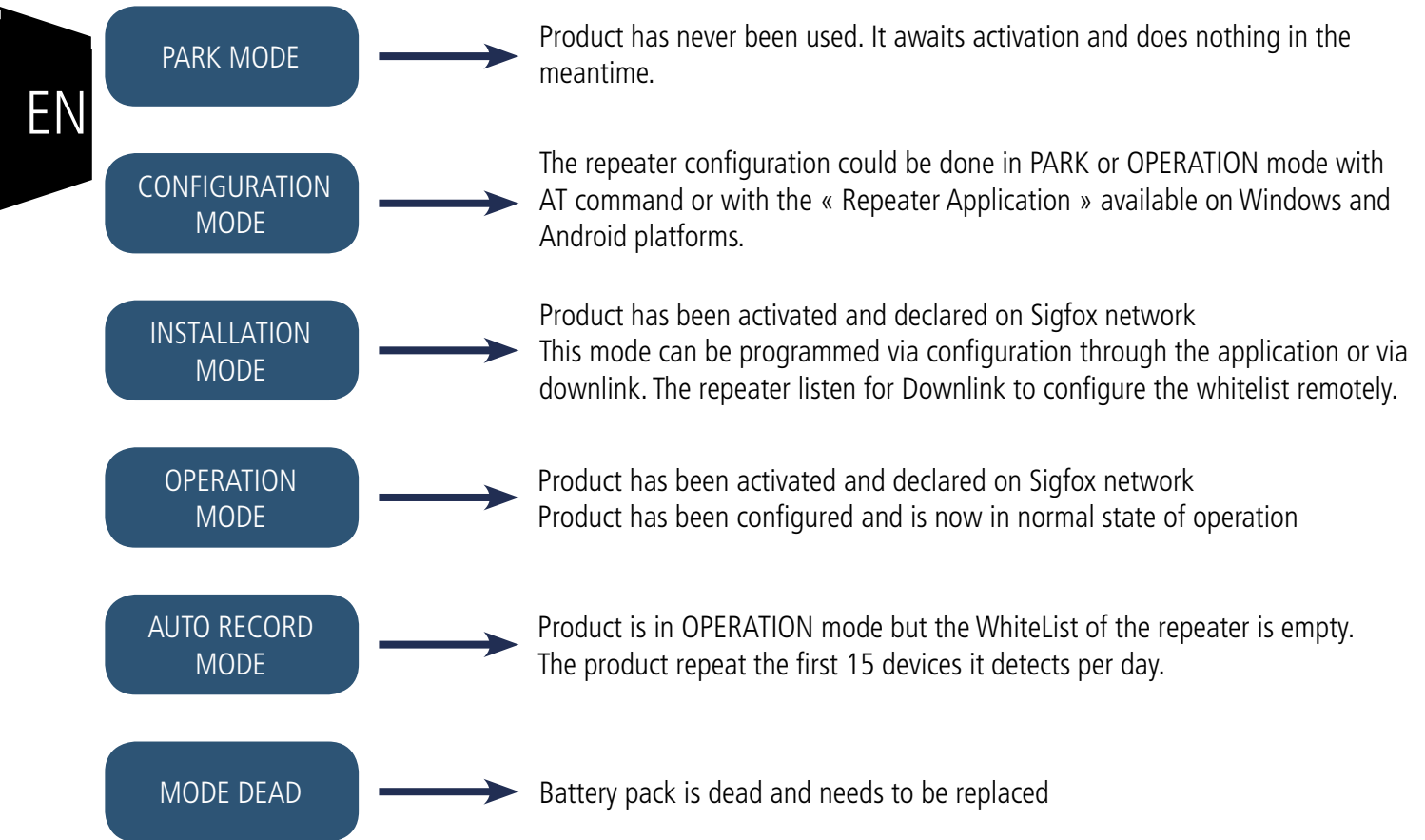

### 2.1. Configure the White List

The White List of the repeater can be configured in 3 different ways.

#### - «Auto-record» mode



When activated, if the White List of the repeater is empty, the repeater will enter in OPERATION mode with Auto-record and repeat automatically the first 15 devices detected. A reset of this list of IDs is made every time the Status frame is sent to the sigfox back-end (24h by default, linked to the S300 register). It is possible to freeze this list of repeated device to make it permanent with a downlink (see downlink section). Be careful, in this mode the product can repeat sigfox devices that you don't know and if you freeze the list it will freeze the unknown devices as well.

**PAY ATTENTION** : this mode is not recommended in noisy environment.



#### - Via USB

Configure the White List thanks to the repeater application or using AT commands. Refer to the dedicated section (2.3.1.03)

#### - Via Downlink



The repeater can be switched into INSTALLATION mode via a downlink. In this mode the repeater will stop to repeat device and will listen for downlink containing the ID of the device to be added to the White List. In OPERATION mode, every day (frequency linked to the status frame - S300 register) the repeater opens a listening phase to receive a downlink to add or remove ID from the White List. Refer to the dedicated section (3.0 Operation mode)



## 2.2. Activating the repeater

By default the repeater is in PARK mode. In order to be used, it needs to be declared on the sigfox back-end and then activated. For this, a magnet is needed. The following sequence has to be followed:

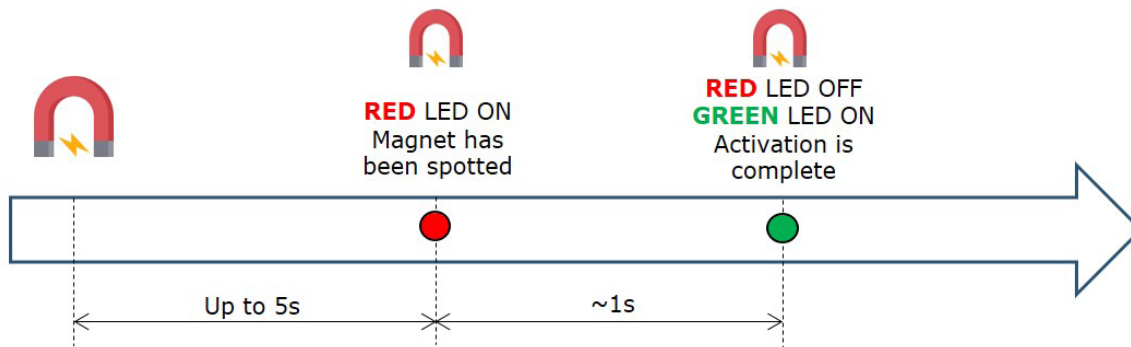

**NOTE:** the magnet must be maintained until the GREEN LED lights up. Otherwise, start again. The magnet zone is shown on paragraph « 6.3 Starting up the product using a magnet ».

Once the product has been activated, it switches to operation mode.

## 2.3. Configuration mode

The repeater configuration could be done in PARK or OPERATION mode with the « Repeater Application » available on Windows and Android platforms or with AT command.

### 2.3.1 Configuration through the Repeater Application

The Repeater Application follows the below flowchart:

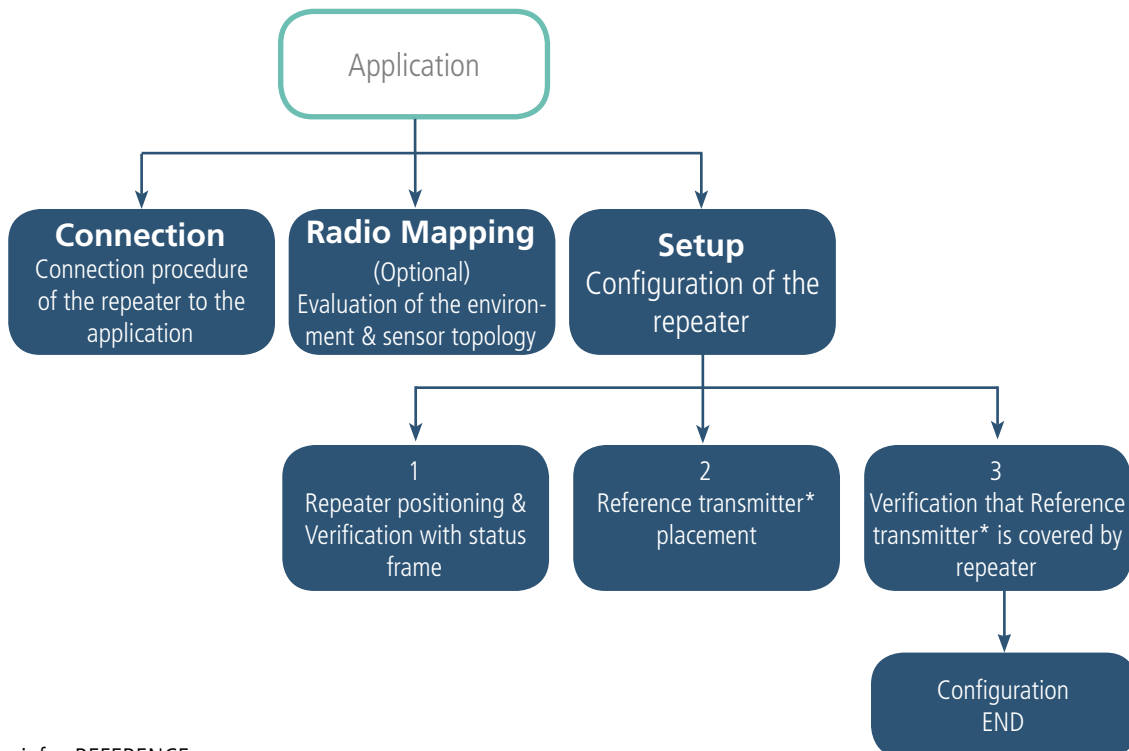

\*The adeunis sigfox REFERENCE TRANSMITTER (ARF8260) is a device tool to help install the repeater (see product user guide for more information).

EN

### 2.3.1.01 Connection

This first step shows you how to connect your repeater to your tablet, phone, etc.

- Android devices : you need an OTG cable to connect to your tablet/phone
- Windows devices : you need a driver available on adeunis' website

EN

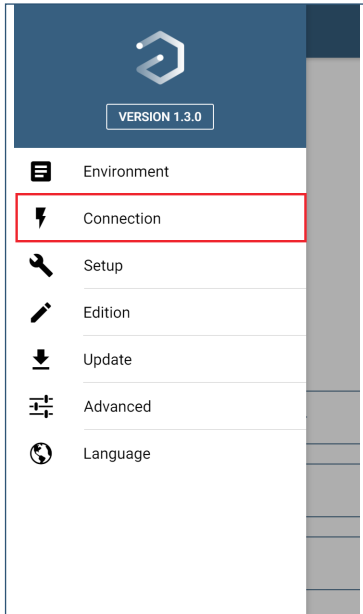

1. Click on «Connection»

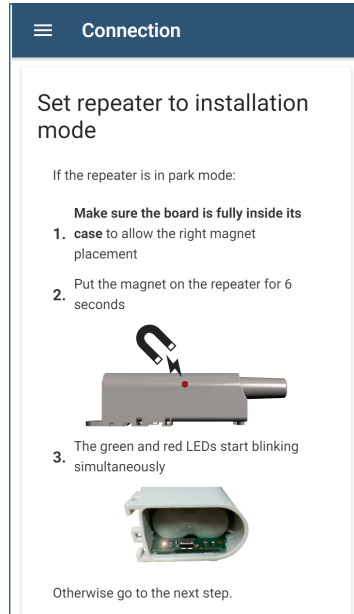

2. See section 2.1

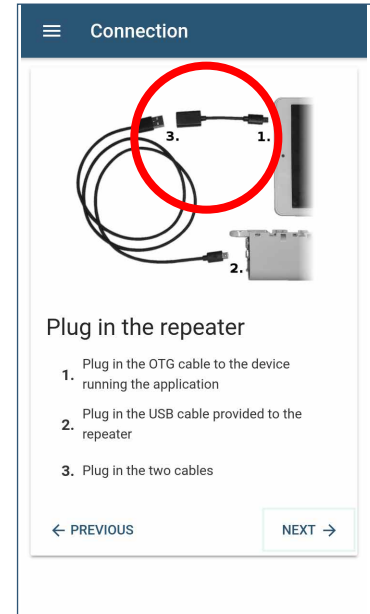

3 . Connect the device **PAY ATTENTION** to the cables: if reversed, the connection won't work.

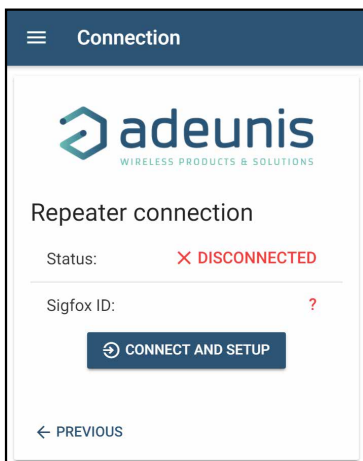

4. Click « Connect »

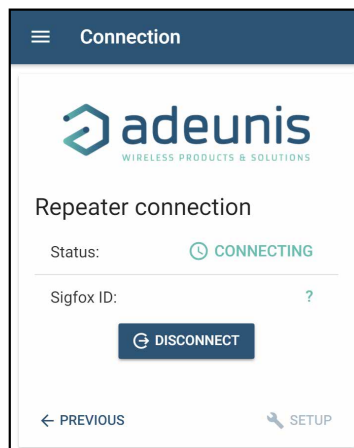

5. Once connected, the repeater ID is displayed

Once your device is properly connected, you can either go to the « Radio Mapping » section (optional) or the « Setup » section.

### 2.3.1.02 Radio mapping (Optional)

The « Radio Mapping » section helps you to determine how many repeaters you'll have to deploy for a given sensor topology.  
**It gives a general overview but the result cannot be taken « as is » : field experimentation is mandatory to ensure proper coverage of all devices.**

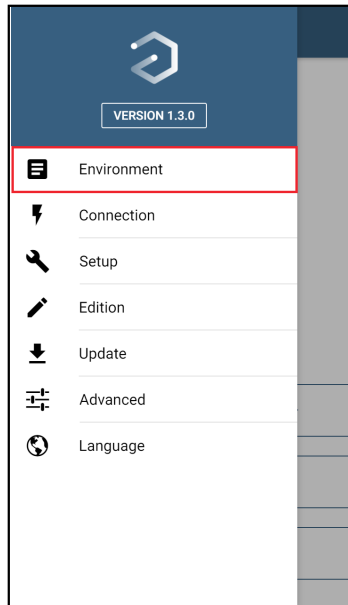

1. Click on « Environment »



2. Click on «Start Radio Mapping»

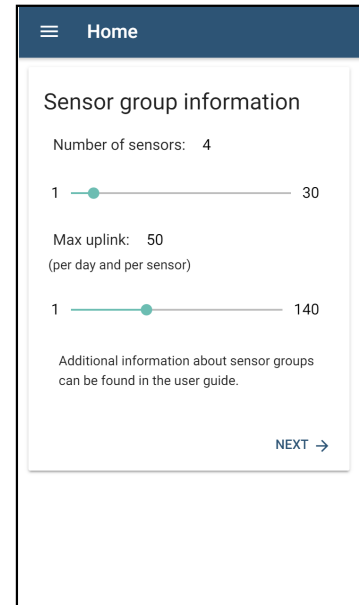

3. Indicate the number of sensors to be repeated and their uplink traffic volume

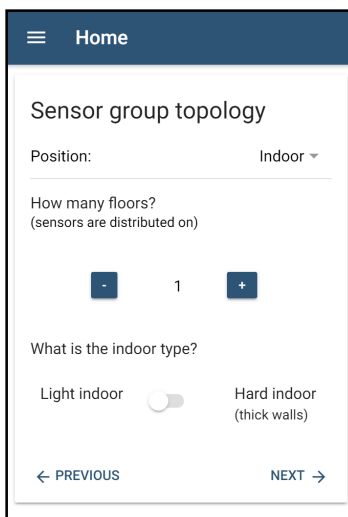

4. Sensor group topology asks in which environment the sensors are deployed

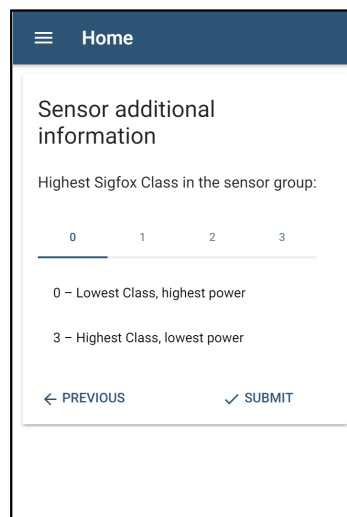

5. Additional information asks for the sensor's SIGFOX class

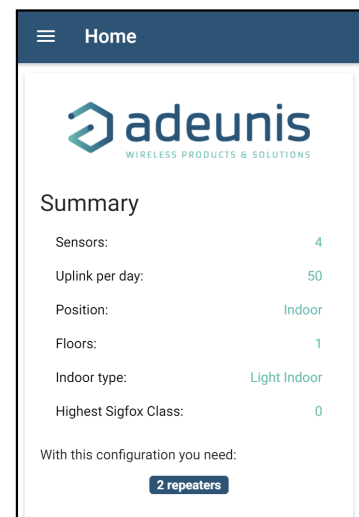

6. A summary is displayed

EN

### Definition of a group

Depending on the site, the sensors can be scattered in different ways. It is impossible to cover all cases in the application, hence the notion of group was introduced. An group of sensors can be defined as any number of sensors contained within a bubble of 50m radius:

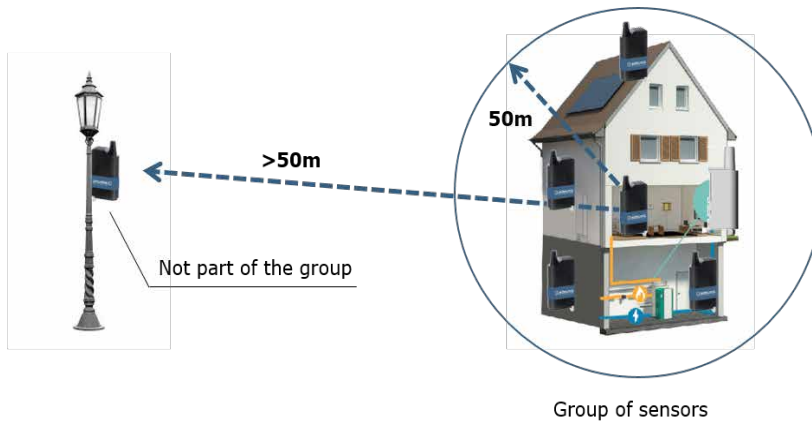

### Topologies description

Different types of environment are identified:

Type	Description
Outdoor	The device is placed in an open area, without specific obstruction
Light indoor	The device is placed indoor, in a not-too-harsh environment: near windows, outer walls, open-space type environment, floors where rooms are separated by light partitions
Hard indoor	The device is placed indoor, in an environment that contains heavy concrete / metal walls
Deep indoor	The device is placed in underground-type environments (cellar, basement, etc.)
Mixed	Mix of either of the above
Unknown	/

#### 2.3.1.03 Setup

The setup section guides the user through the process of installation & configuration of the repeater.

**The Sigfox Repeater has to be connected before going through this phase (see section 2.2.1.01).**

- Step 1: White List configuration**

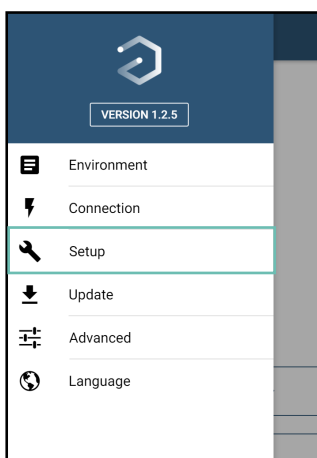

1. Click on « Setup »

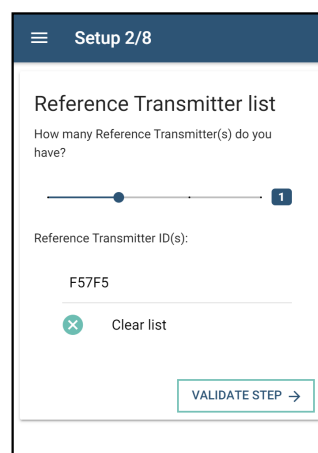

2. Enter the IDs of the Reference Transmitter you have in your possession

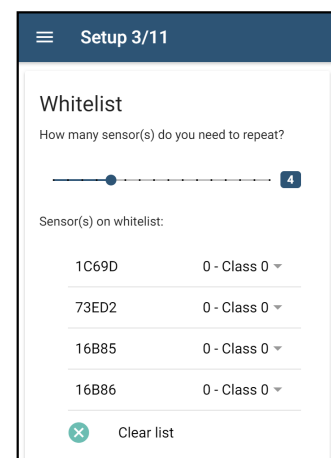

3. In order to be repeated, the sensors IDs have to be entered in a WHITELIST. IDs that are not in the Whitelist will not be repeated

• **Step 2 : last elements of configuration**

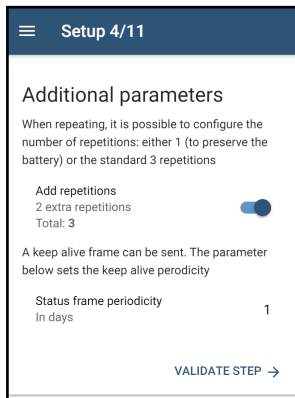

Before finishing the configuration, a few other elements need to be checked :

- The number of repetitions. A classic SIGFOX device uses 3 « repetitions » when transmitting : the first transmission + 2 repetitions. The repeater allows to choose to only do the first transmission if we want to preserve the battery. This configuration is at your own risk : use it only if radio conditions are good.
- The keep-alive message periodicity. By default, the repeater sends a keep-alive message every 24h. this periodicity can be changed.



• **Step 3 : Repeater positioning**

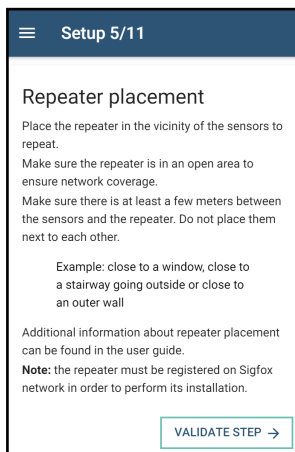

During this step, try to position the repeater in the environment and check that it is seen by the SIGFOX network.

The repeater should be placed intelligently: at approx. equal distance from all sensors, while simultaneously near opened areas to make sure it reaches the SIGFOX network. For example:

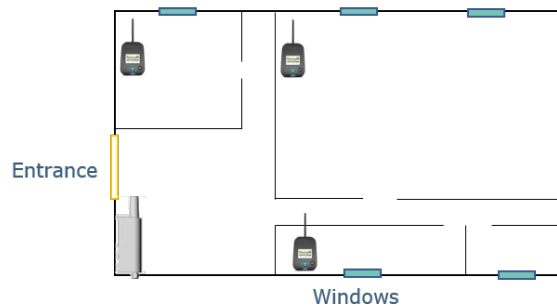

Once the repeater placed, check that the choice is good by verifying if the repeater is covered by the SIGFOX network. For this, use the online server that SIGFOX has set up for such purposes, or check on your sigfox backend account the quality of the radio link of the repeater frames :

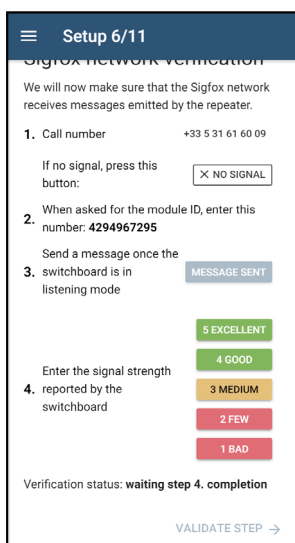

The application will tell if the chosen location is satisfactory or not.

• **Step 4 : Positioning of the Reference Transmitter**

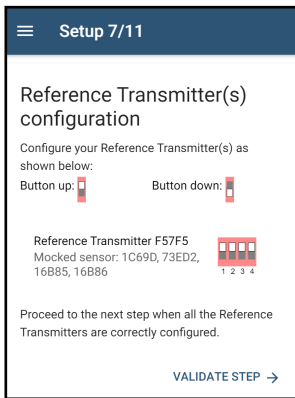

Once the repeater well placed and seen by the SIGFOX network, the next logical step would be to check that it sees the devices that have to be repeated. This step can be problematic because most of SIGFOX products out there are devices that transmit very few information per day : two messages per day, for example, is a common scenario.

In those cases it will be difficult to check that the devices are properly repeated. So, the « Reference Transmitter » helps to solve these problems. The Reference Transmitter can be configured to send frames every 10 seconds or 1minute and for any SIGFOX Class.

The table below gives the different SIGFOX classes that exist for RC1 zone:

RC1 SIGFOX Class	Associated EIRP (Equivalent Isotropic Radiated Power)
0	$EIRP \geq 12dBm$
1	$12dBm \geq EIRP > 7dBm$
2	$7dBm \geq EIRP > 2dBm$
3	$EIRP < 2dBm$

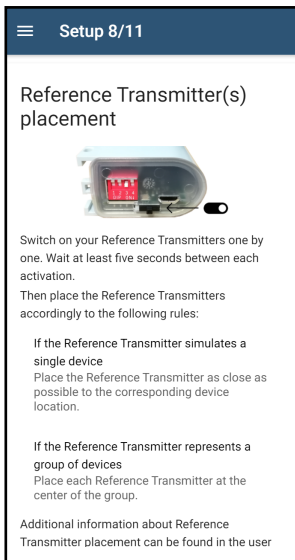

The Reference Transmitter is configured through a switch array (see Reference Transmitter documentation). The Application shows a picture of how to configure the switches.

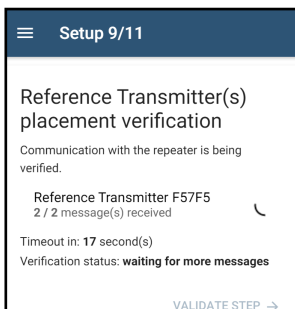

Since the Reference Transmitter emulates a real sensor, it should be placed as close as possible to the actual sensor you need to repeat. This is important because the environment can have an important impact on radio waves propagation :

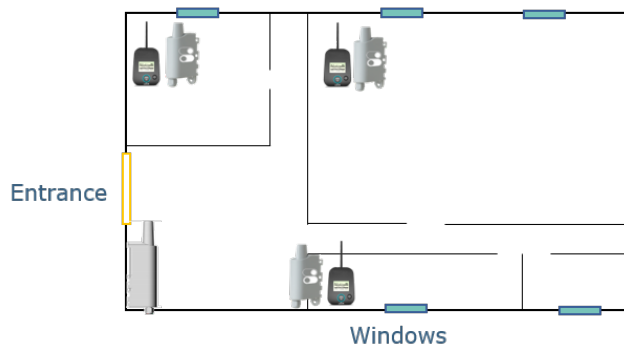

The remaining time for Reference transmitter placement test, as well as number of messages are provided since 1.3.0 application version . The Reference Transmitters will send messages to the repeater and the application will check the number of received messages. If a sufficient amount of messages is received within the allowed timeframe, the application will consider the device properly covered by the repeater and proceed to the next step.

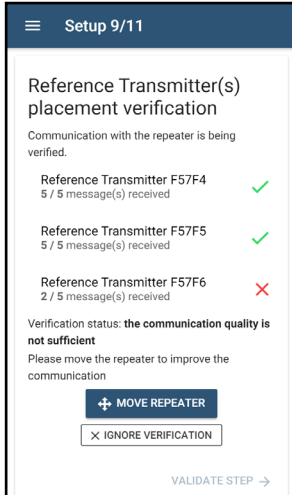

If the reference transmitter placement verification failed, the repeater (or the sensor/reference transmitter) should be moved to improve connectivity between the repeater and the reference transmitter.

However, in some cases (for instance in cases of very noisy environment while testing), this verification should be ignored.

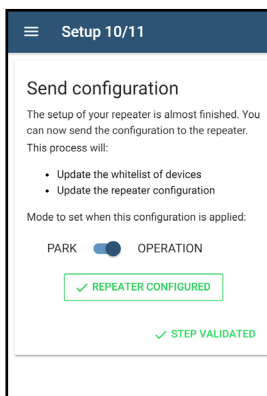
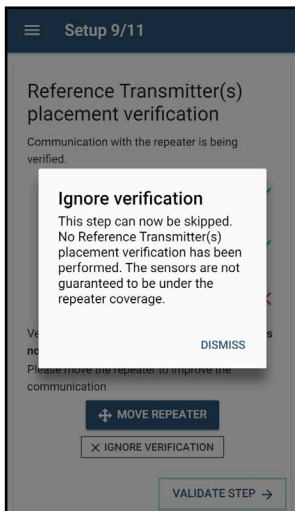

- **Step 5: device configuration**

The application now loads the configuration in the repeater.  
**Note that you can put your device in PARK mode at this step.**

The configuration is now completed and the repeater switches to operation mode.

### 2.3.1.04 White list edition

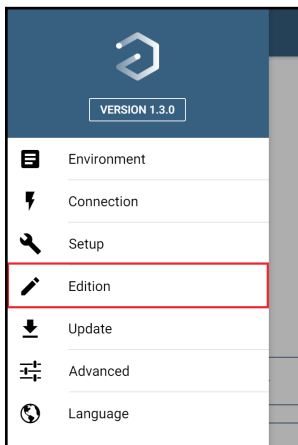

White list edition can be done over one single tab accessible over "Edition" menu. White List edition is recommended only once a full configuration of the repeater has been already performed previously.

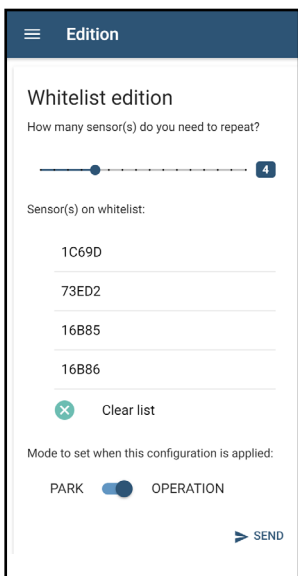

White list can be edited or cleared. In addition, the repeater can be also switched to PARK mode after this set-up change.

### 2.3.1.05 Advanced - Expert view: Duty Cycle check disable/re-enable

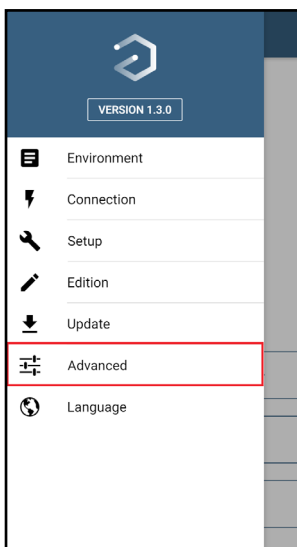

Duty cycle check can be disabled temporarily for 24hours or definitely disabled over Advanced menu.



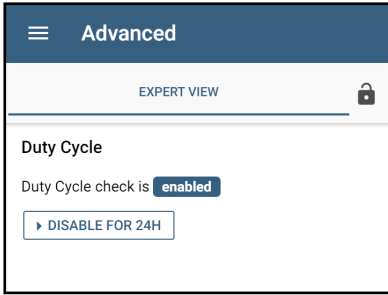

To disable duty cycle check, just click on DISABLE FOR 24H or DISABLE.

**To disable the duty cycle the repeater should NOT be in PARK mode or set back in PARK mode. Indeed, in those cases, duty cycle check will not be disabled.**

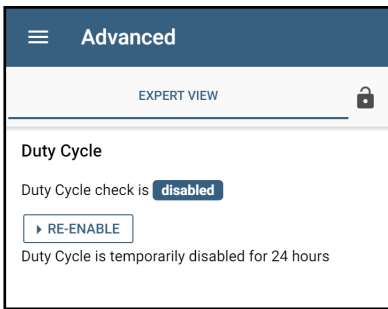

Duty cycle is re-enabled:

- Automatically after 24H (if the "Disable 24h" has been chosen)
- Or when the user re-enabled it via DL or via configuration through the application



### 2.3.1.06 Advanced - Expert view: Statistics access

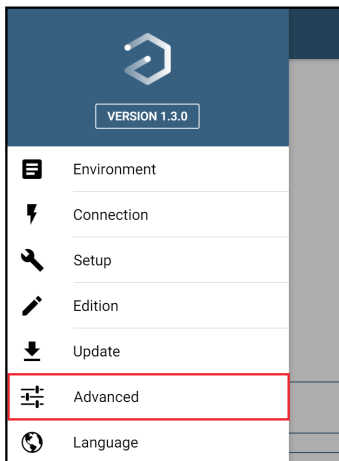

Repeater statistics are visible over Advanced menu.

Out of regulation represents the number of messages that are not repeated because of the duty cycle (36s of transmission per hour). If this number is regularly not null, it is advisable to reduce the repeater White List and install an additional repeater.

Device not in list represents the number of messages received from devices that are not in the White List. This number is to correlate with the previous graph. If this number has increased and at the same time the number of repeated messages has decreased, one solution may be to reposition the repeater so that it is further away from the disruptive devices and closer to the devices that it must repeat.

Bad CRC: Represents the number of Sigfox messages received with errors. Too many means that there are risks of losing messages to repeat because of a disrupted radio environment. This interference can come from collisions with other sigfox messages (see the previous case), or the presence of an interfering signal near the repeater. If this number has increased and at the same time the number of repeated messages has decreased, it will be necessary to take away the interfering signal source from the repeater (or vice versa)

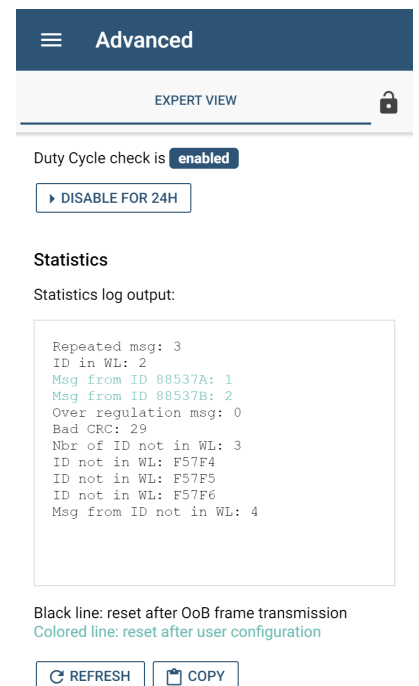

## 2.4. Operation mode

OPERATION mode is the normal mode of operation: the repeater is configured and functional and listens to any upcoming transmission.

There are 2 ways to enter OPERATION Mode from PARK Mode

1. Go through the configuration process using the application (See section 2)
2. Plug & unplug the USB : this will automatically put the repeater in OPERATION mode

OPERATION Mode executes the following (simplified) flowchart:

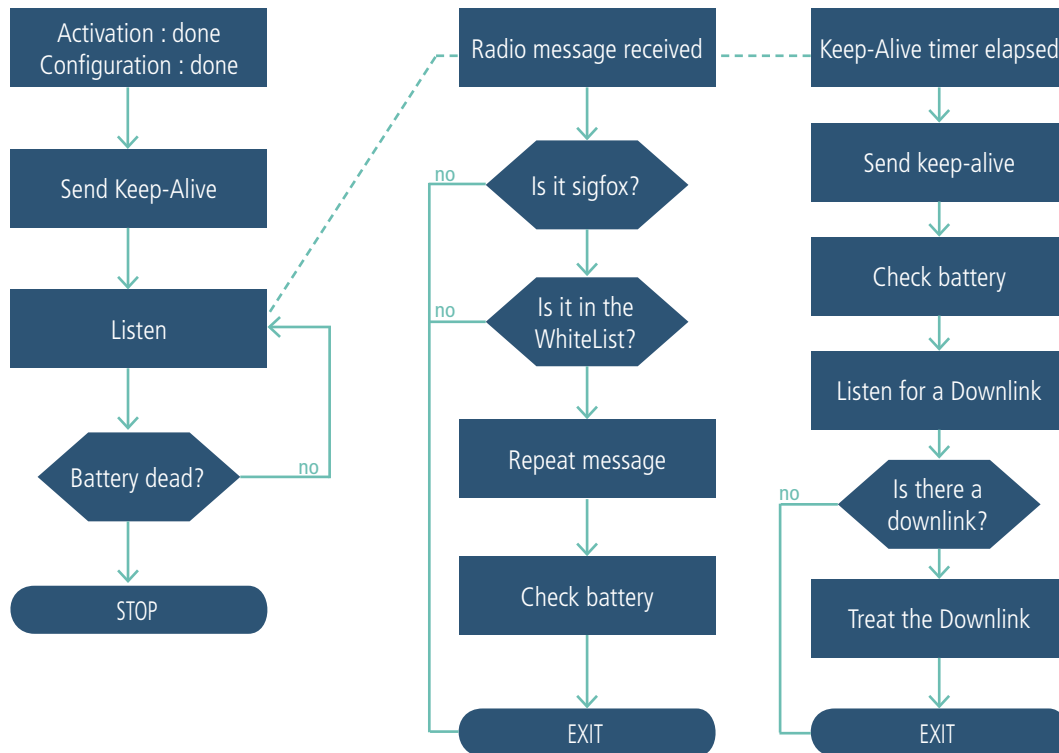

EN

## 2.5. Installation mode

This mode allows to **configure the White List of the repeater remotely thanks to Downlinks**. In this mode, the repeater stops to listen messages from devices and opens "listening phases" to receive one or several Downlinks with the ID of the product(s).

This mode can be activated with a Downlink "Installation mode" or with a Downlink "Change register configuration" choosing S306=1 (see "description register section").

The White List can be completed within 4 days (for 15 IDs), thanks to the 4 daily downlinks included in the sigfox largest connectivity plan.



Return into OPERATION MODE, if:

- 4 UL are sent and no downlink received
- 4 DL are received with error (see DL error code in "downlink section")
- reception of a "WL confirmation" downlink (see "downlink section")
- White List is full (15 IDs provided)

In any case, the repeater will send a "WL confirmation". If IDs are in the White List the repeater will send the number of IDs contained in the WL and turn to operation mode and repeat the message from the device concerned, if the White List is empty, the repeater will send 0 and turn into "auto-record" mode.

## 2.6. Repeater monitoring with the sigfox backend

When receiving the messages from a repeated sigfox device, you should get the following result on the sigfox backend:

2017-11-05 22:28:57	140035d3000000d00030d00		<b>R 68 %</b>	
2017-11-05 10:28:53	022891280035b5030000ff00		<b>R 79 %</b>	
2017-11-04 22:28:49	100035b1000000f00020100		<b>R 70 %</b>	
2017-11-04 10:28:45	0e2892af0035a6030008ff00		<b>R 76 %</b>	

The repeated messages are identified by a percentage (red squares on the previous picture). For any given message sent by a sigfox device, the percentage represents the portion of repetitions coming from the repeater.

### Repeater monitoring:

To benefit from repeater monitoring, **the adeunis sigfox Repeater must be visible from the Sigfox Cloud, so you have to declare it on the backend.** The simplest is to associate it with the contract of the objects which it must repeat. Repeater frames are free. To facilitate maintenance, it is advisable to enter the location of the repeater. Monitoring can be visual or programmed via the callback service repeater.

For monitoring information, the user can also consult the pages relating to his repeater:

- On **INFORMATION** page, the user can check the number of devices in the White List

The screenshot shows the Sigfox backend interface. On the left, a navigation menu has 'INFORMATION' highlighted with a red circle. The main content area displays the details for 'Device 7...1 - Information'. At the bottom of this page, the text 'Number of devices in repeater's whitelist: 2' is circled in red.

- On the **STATISTICS** page, the user can know the status of the battery (VDD graph)

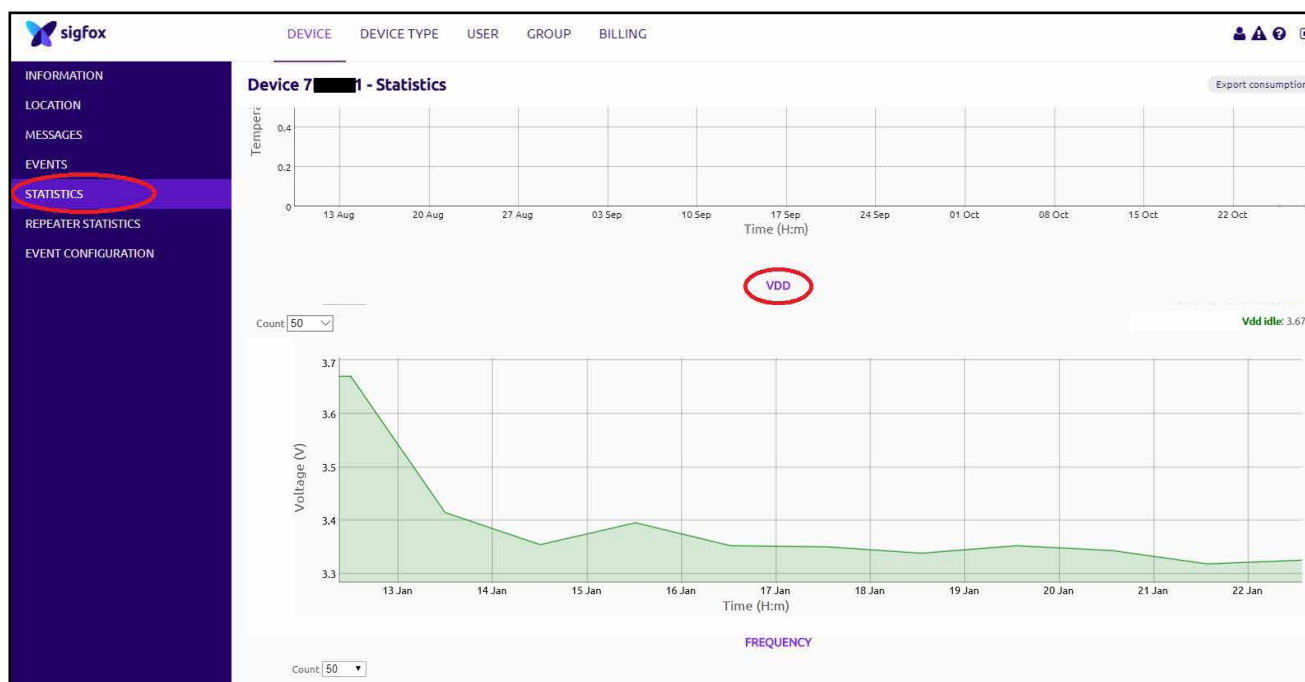

EN

The low battery threshold has to be set to 2700 mV.

- On the **REPEATER STATISTICS** page of the repeater, the user can consult indicators on the radio environment of the repeater:
  - The **MESSAGES-REPEATED** graph indicates the number of repeated messages between two status frames (default 24 hours). If the number of repeated messages decreases abnormally, it may be a failure of the device(s) to be repeated, or a change in the radio environment of the repeater. The following graphs help refine the diagnosis:



- The **DEVICES\_NOT\_IN\_LIST** graph represents the number of devices that are not in the White List and that are received by the repeater between 2 status frames. Too many numbers can cause collisions between the frames of these devices and the frames to be repeated.



- The **MESSAGES\_NOT\_REPEATED** graph represents the number of unrepeated messages between two status frames (by default on 24h):

- Out of regulation represents the number of messages that are not repeated because of the duty cycle (36s of transmission per hour). If this number is regularly not null, it is advisable to reduce the repeater White List and install an additional repeater.
- Device not in list represents the number of messages received from devices that are not in the White List. This number is to correlate with the previous graph. If this number has increased and at the same time the number of repeated messages has decreased, one solution may be to reposition the repeater so that it is further away from the disruptive devices and closer to the devices that it must repeat.
- Bad CRC: Represents the number of Sigfox messages received with errors. Too many means that there are risks of losing messages to repeat because of a disrupted radio environment. This interference can come from collisions with other sigfox messages (see the previous case), or the presence of an interfering signal near the repeater. If this number has increased and at the same time the number of repeated messages has decreased, it will be necessary to take away the interfering signal source from the repeater (or vice versa)



The user can also define a SERVICE REPEATER callback in the device type of the repeater to, for example, analyze trends on the different monitoring data and trigger alerts on exceeding thresholds.

This SERVICE REPEATER callback will be activated at each status frame according to the periodicity defined during the configuration of the repeater. The available monitoring variables are as follows:

- Batt (float): the voltage of the battery (in Volt – Float value with two maximum fraction digits)
- White ListDevices (int): the number of devices in the White List. If 0, all messages are repeated
- RepeatedMsg (int): the number of repeated messages since the last status frame transmission
- UnwantedDevices (int): the number of unique devices not in the White List received since the last status frame transmission. If 15, means that the number is >14

- UnwantedMsg (int): the range of sum of number of messages received from all devices not in the White List: not repeated messages since the last status frame transmission:

- 0:0,	- 8:<300,
- 1:<5,	- 9:<350,
- 2:<10,	- 10:<400,
- 3:<50,	- 11:<450,
- 4:<100,	- 12:<500,
- 5:<150,	- 13:<800,
- 6:<200,	- 14:<1000,
- 7:<250,	- 15:>1000

- WrongMsg (int): the range of total number of malformed frames received since the last status frame transmission:

- 0:0,	- 8:<300,
- 1:<5,	- 9:<350,
- 2:<10,	- 10:<400,
- 3:<50,	- 11:<450,
- 4:<100,	- 12:<500,
- 5:<150,	- 13:<800,
- 6:<200,	- 14:<1000,
- 7:<250,	- 15:>1000

- OverRegulMsg (int): the range of number of messages not repeated due to compliance with local regulation since the last status frame transmission:

- 0:0,	- 8:<300,
- 1:<5,	- 9:<350,
- 2:<10,	- 10:<400,
- 3:<50,	- 11:<450,
- 4:<100,	- 12:<500,
- 5:<150,	- 13:<800,
- 6:<200,	- 14:<1000,
- 7:<250,	- 15:>1000

### 3. DEVICE CONFIGURATION WITH AT COMMANDS

If you do not want to use the application, it is also possible to configure the device through a terminal and classic AT commands (**not recommended**).

Indeed, the Sigfox Repeater can be configured using the USB connector.

This connection allows you to communicate with the device via a virtual com port and to transmit AT commands in order to modify the parameters of the device.

EN

**WARNING :** the USB connection does not supply power to the product, it induces a consumption of the product as long as the one is connected. It is therefore important not to leave the product connected too long.

#### 3.1. Connecting the device to a computer

Connect the product to the USB input of a computer. The product has a Type B micro USB connector.

During connection, the device must be recognized by the computer as a Virtual Com Port (VCP) device.

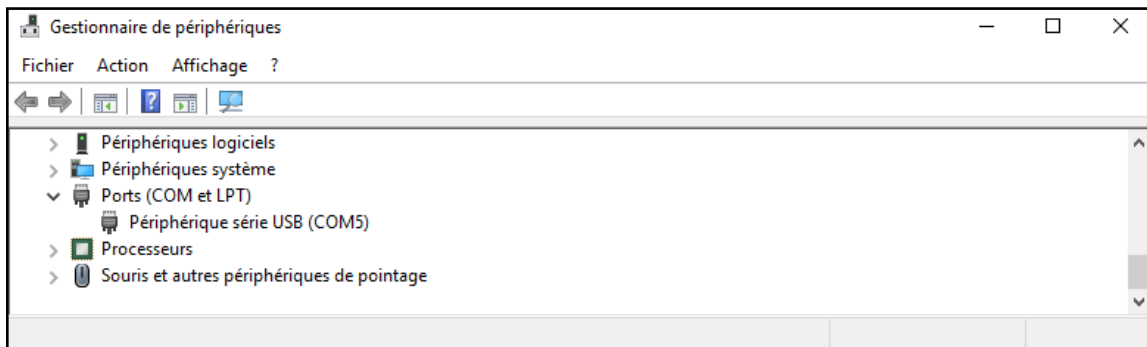

Using Windows: Verification that the device has been recognized to be functioning properly can be obtained by consulting the device manager. You should see the USB series device with a corresponding COM port number appear during connection.

If you are not able to see a device of this type, you must install the USB driver for this device, available to download from our website: <https://www.adeunis.com/en/produit/repeteur-2/>

Select:

- DRIVER - stsw-stm32102\_vcpdriver

#### 3.2. Command mode

Use a COM port terminal in order to communicate with the device. We use the HERCULES COM port soft terminal available to download for free by clicking on the following link: [https://www.hw-group.com/products/hercules/index\\_en.html](https://www.hw-group.com/products/hercules/index_en.html)

With Hercules, select the "Serial" tab, then configure the serial port with the following serial parameters:

Parameters	Value
Rate	115 200 bps
Parity	None
Data	8
Stop Bit	1

- Select the serial port on which the device has been created with Windows (Name).
- Click on the "Open" button to open the serial port.

**NOTE INFORMATION:** If the com port has been opened correctly, Hercules will display the message "Serial COM3 port opened". Alternatively, "Serial port com opening error" will be displayed, meaning either that the com port is already open for another application, or it does not exist.



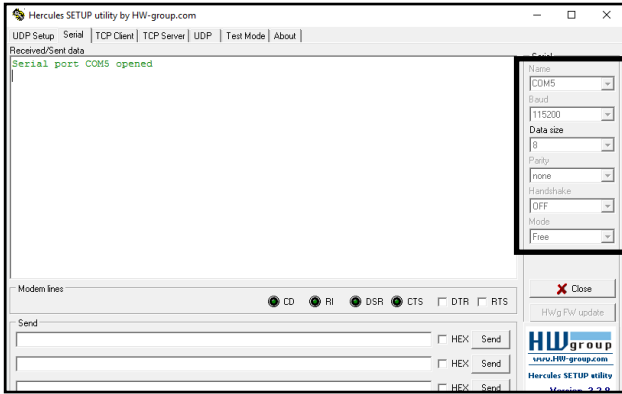

You must send a specific frame in order to move the device to configuration mode.  
 Frame expressed in hexadecimals: 0x2B 0x2B 0x2B ou « +++ ».

For Hercules, this frame must be entered in one of the 3 lines available at the bottom. The hexadecimal format must be expressed using a "\$" in this program, which gives us the following frame: \$2B\$2B\$2B



Send the transition frame in command mode in order to switch the device to configuration mode by clicking on the SEND button.

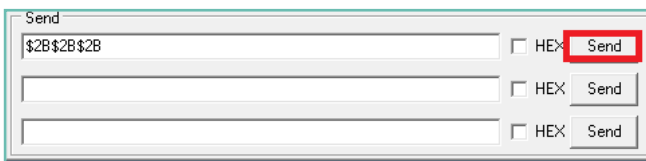

After a few seconds, You must see the 2 LEDs light up permanently.

On the com port terminal, you should also have «CONNECTING...» et « CM » feedback for Command Mode.  
 Sending a character on Hercules is displayed in magenta and receiving a character is displayed in black. If you do not see sending characters, this is probably because ECHO is not active on this program. To activate the option in the accessible menu, right click in the viewing window.

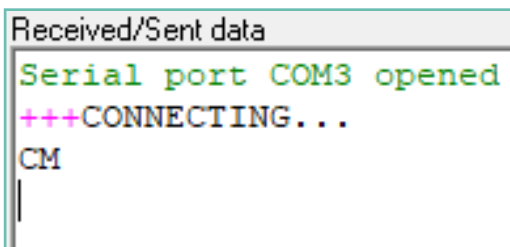

### 3.3. Configuration through a terminal and AT Commands

A command starts with 2 ASCII characters: "AT", followed by one or more characters and data (see the list below for the syntax of AT commands available on the modem).

Each command must finish with a "CR" or "CR" "LF" – both are acceptable.

(CR indicates: Carriage Return, LF indicates: Line Feed)

Once the command has been received, the modem will feedback:

<cr><lf> "Data" for ATS type playback control <n> ?, AT/S or AT/V

"O" <cr><lf>, for any other command when this has been accepted.

"E" <cr><lf>, if it refuses the command due to a syntax error, unknown command, unknown range, invalid parameter, etc.

"CM" <cr><lf>, if it accepts the input in command mode

The available commands are:

Command	Description	Comment
+++	Enter Command mode	CONNECTING... <cr><lf> CM<cr><lf>
AT/V	Display product version	APP_8181AAA_PRG1701_ V01.00.02:RTU_8120AAB_PRG_1701_ V01.00.01
AT/S	Display registers list	/
ATS<n>=<m>	Transfers the 'm' value to the register 'n'	«O»<cr><lf> if Ok, «E»<cr><lf> if error, «W»<cr><lf> if coherency error
ATS<n>?	Return content of register 'n'	S<n>=<y><cr><lf> with <y> as the register content
AT&W	Saves the current configuration to non-volatile memory	«O»<cr><lf>, «W»<cr><lf> if coherency error
ATO	Exit command mode and return to operation mode	«O»<cr><lf>, «W»<cr><lf> if coherency error
AT/d	Display user and provider register	Display Sigfox ID and PAC on top of user registers also provided by AT/S command. ATT63 PROVIDER command must be entered prior to AT/d command.
ATLOG	Display repeater data collected between to OoB frame transmission	See example hereafter*

\*This command displays repeater data counter information collected between 2 OoB frame transmission

ATLOG<CR><LF>

Repeated msg: 6 => Clear after OoB transmission

ID in WL: 1 => Clear after configuration

Msg from ID F91E0: 6 => Clear after configuration

Over regulation msg: 2 => Clear after OoB transmission

Bad CRC: 18 => Clear after OoB transmission

Nbr of ID not in WL: 1 => Clear after OoB transmission

ID not in WL: AB11E0 => Clear after OoB transmission

Msg from ID not in WL: 11 => Clear after OoB transmission

Example of a set of commands and corresponding responses that can be seen on the terminal:

Syntax of the order	Description	Response Syntax to Next Line
+++	Input request in command mode	CONNECTING... CM
ATS300=2	Changing the transmission period of the Status Frame	0
ATS300?	Feeds back the value of the S300 register	S300=2
AT&W	Memory request for the state register	0
ATO	Output request in command mode	0

Interpreting the previous example: the user wanted to modify the the transmission period of the Status Frame. The register S300 was verified and the parameters were saved before exiting. When exiting command mode, the device will start a new cycle of emission.

### 3.4. Description of the registers

ON switching on the product works according to the last saved configuration (Factory Configuration if it is the first start, or if this configuration has not been changed).

Commands such as Modification TTY<n>=<M> allow you to change the content of the registers: <n> representing the number of the register and <m> the value to be assigned. This latter is either a decimal value or a hexadecimal value consistent with the «encoding» column of the tables below.

Examples :

- ATS300=6 assigns the decimal value 6 in register 300
- ATS303=2 assigns the hexadecimal value 0x02 in register 302

It is imperative to save the parameters with the command AT&W before exiting the Command mode otherwise all changes will be lost.

**IMPORTANT:** The registers that are not documented (that can appear in the list following the AT/S or AT/d command) in the paragraphs that follow are reserved and must not be changed.

The list of registers below allows you to change the behavior of the product application.

Register	Description	Coding	Details
S300	Transmission period of the Status Frame	Decimal	Default: 1 Min/max: 1 to 49 Unit: days
S303	Number of repetitions	Decimal	Default : 2 Range : 0 or 2 (1 is forbidden)
S304	Duty cycle	Decimal	Default : 0 0= duty cycle control enabled 1= duty cycle is disabled for 24 hours 2= duty cycle is always disabled
S306	Product mode	Decimal	Default : 0 Possible values : 0 or 2 0: park mode 1: Installation mode (White List via downlinks) 2: operation mode
S380 to S394	sigfox devices to repeat (White List)	Hexadecimal	These registers contain the IDs of the sigfox devices that need to be repeated. <ul style="list-style-type: none"> <li>• IDs that are not in the White List will not be repeated.</li> <li>• One register = 1 ID. E.g. : register 380 = 0x00FF276</li> <li>• The White List can contain up to 15 devices</li> <li>• If the White List is blank ==&gt; see IMPORTANT NOTE hereafter</li> </ul>



For example in the screenshot below we can see how to update your White List :

- Enter in Command mode (+++)
- Display registers list (AT/S) – this is optional still useful to check how many Sigfox devices (and which ones) you declared previously in this repeater
- Add an ID Sigfox at the 3rd place of white (ATS382=B6C51)
- Following command (AT/S AT&W ATO) just verify and save the changes done above.

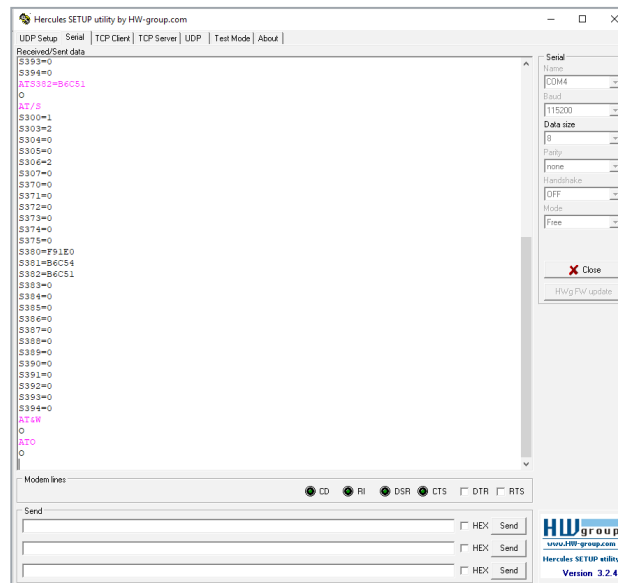

**IMPORTANT NOTE** : If the White List is blank (all registers to 0), the repeater will repeat the 15 first sigfox devices it sees. This means that the White List (register 380 to 394) is automatically completed by the Sigfox Repeater. The Sigfox Repeater uses this list of ID until the next transmission of its Status Frame (with the period given by register 300)and after transmission the list is again emptied (and the previous steps are repeated...).

**WARNING** : Using an empty White List is at your own risk : repeating any device means more power consumption (reduced battery life) and potential break of the Duty Cycle limit. In that case the repeater will automatically limit itself and discard upcoming messages.

## 4. DESCRIPTION OF THE REPEATER FRAMES

### 4.1. Uplink frame

All of the uplink frames of the product to the network (uplink) always have a size of 11 bytes.

#### 4.1.1 Fixed bytes

The first two bytes of the frame are systematically dedicated to indicate the frame code and the status as presented below:

0	1	2	3	4	5	6	7	8	9	10
Code	Status	PAYLOAD								

##### 4.1.1.01 Byte code

This byte contains the code associated with the frame to facilitate its decoding by the data system.

##### 4.1.1.02 Status Byte

The status byte is broken down in the following way:

Alarm Status	Bit 7	Bit 6	Bit 5	Bit 4	Bit 3	Bit 2	Bit 1	Bit 0
	Frame Counter				RFU	RFU	RFU	Low bat
No Error	0x00 to 0x0F				0	0	0	0
Low bat					0	0	0	1

Details of the fields:

- Low Bat: bit at 1 if the battery voltage is less than 2.5V, otherwise 0. This information remains permanent.

#### 4.1.2 Ask for a new ID in the White List

This 0x01 frame is sent only in INSTALLATION mode to allow the reception of a downlink "add an ID in the White List" (other downlink will be rejected).

0	1	2	3	4	5	6	7	8	9	10
Code	Status	PAYLOAD								
0x01	Cf status	X	X	X	X	X	X	X	X	X

Since the largest sigfox connectivity plan only allows a maximum of 4 downlinks per day, this frame will be sent 4 times a day maximum or the number of time specified in the register S307 (number of DL/day).

#### 4.1.3 Ask for White List modification or configuration modification

This 0x02 frame is sent only once a day before "keep alive" frame in OPERATION mode to allow the reception of one of the following downlink:

- Suppress all IDs from the White List and switch repeater into PARK, INSTALLATION or OPERATION mode
- Delete an ID from the White List
- Add an ID in the White List
- Modify repeater configuration
- Freeze the list of devices repeated in "auto-record" mode into the White List

Other downlink will be rejected.

0	1	2	3	4	5	6	7	8	9	10
Code	Status	PAYLOAD								
0x02	Cf status	The number of IDs in White List or repeated in «auto-record» mode	X	X	X	X	X	X	X	X
0x02	0xA3	0x02								



Description of the frame:

- Byte 2 : The number of IDs in White List or repeated in «auto-record» mode

In the example in grey this gives:

- Byte 2=0x02: 2 IDs are in the White List or the repeater is repeating 2 devices in "auto-record" mode

EN

#### 4.1.4 Reporting of downlink success or failure

This 0x03 frame is consecutive to the reception of a downlink, and indicates whether the action linked to the downlink has been correctly executed or not. In the case the Downlink has not been received this confirmation frame can not be sent.

0	1	2	3	4	5	6	7	8	9	10
Code	Status	PAYLOAD								
0x03	Cf status	Downlink frame code	Error code*	X	X	X	X	X	X	X
0x03	0xA3	0x02	0x04							

\*The error code is linked to the downlink sent, see "error code" section to know error code meaning for each downlink.

Description of the frame:

- Byte 2 : The frame code of the corresponding downlink
- Byte 3 : Error code (see the "error code" section)

In the example in grey this gives:

- Byte 2=0x02: the corresponding downlink is 0x02 "Delete ID"
- Byte 3=0x04: means that the ID is not found in the White List

#### 4.1.5 White List confirmation

This 0x04 frame is sent at the end of the INSTALLATION mode before to switch into OPERATION MODE, following one of the listed actions:

- A White List confirmation has been sent in the last "add an ID" downlink
- The White List is full (15 IDs provided)
- The last 4 uplinks "Add an ID" do not receive any downlink in return

0	1	2	3	4	5	6	7	8	9	10
Code	Status	PAYLOAD								
0x04	Cf status	Number of IDs in the White List	X	X	X	X	X	X	X	X
0x04	0xA3	0x0B								

Description of the frame:

- Byte 2 : number of IDs in the White List
  - 0x00= White List is empty, the repeater will switch into "auto-record" mode
  - 0x01 to 0x0F= The number of ID in the White List, the repeater will switch into OPERATION mode

In the example in grey this gives:

- Byte 2=0x0B: 11 IDs of devices are in the White List

### 4.1.6 Summary of the conditions of transmission of uplink frames

The table below summarizes the conditions of the transmission of the different uplink frames:

Code	Description	Sending conditions
0x01	Ask for a new ID in the White List	<ul style="list-style-type: none"> <li>• in INSTALLATION MODE</li> <li>• 4 times a day maximum or the number of time specified in the register S307 (number of DL/day).</li> </ul>
0x02	Ask for White List modification or configuration modification	<ul style="list-style-type: none"> <li>• Start-up of the product</li> <li>• Once a day in OPERATION MODE</li> </ul>
0x03	Reporting of downlink success or failure	<ul style="list-style-type: none"> <li>• Following the reception of a Downlink frame</li> </ul>
0x04	White List confirmation	<ul style="list-style-type: none"> <li>• At the end of the INSTALLATION mode                             <ul style="list-style-type: none"> <li>• if White List confirmation has been sent in the last "add an ID" downlink</li> <li>• if White List is full (15 IDs provided)</li> <li>• if the last 4 uplink "Ask for a new ID" do not receive downlink in return</li> </ul> </li> </ul>

EN

### 4.2. Downlink frames

SIGFOX technology allows up to 4 downlink messages to be transmitted (from the network to the product) per day depending on the subscription.

A downlink message is in fact an acknowledgment of receipt of an uplink frame with a request for acknowledgment. This means that, to receive a message on the product, an uplink frame (from the product to the network) must indicate an acknowledgment wait.

This acknowledgment downlink frame is an 8 byte message defined for the adeunis® product in the following two paragraphs.

Hence the product sends an uplink frame with the ACK field enabled, it then returns to standby for twenty seconds before opening a reception window (RX window) for a maximum of 30 seconds, in accordance with the diagram below:

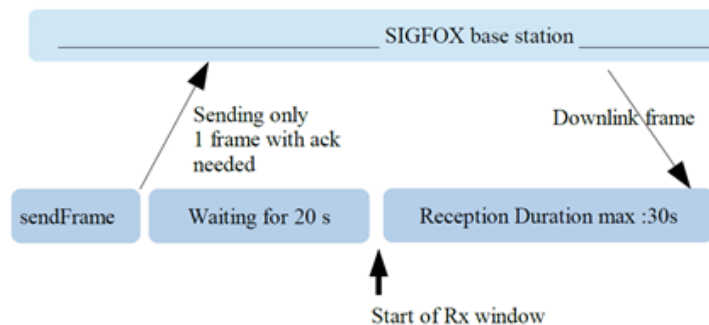

#### 4.2.1 Suppress all IDs from the White List and switch repeater into PARK, INSTALLATION or OPERATION mode

This 0x01 frame follow the uplink "Ask for White List modification" (0x02) enables to delete all the IDs from the White List and to switch the repeater into PARK, INSTALLATION or OPERATION mode.

0	1	2	3	4	5	6	7
Code	PAYLOAD						
0x01	Return mode	X	X	X	X	X	X

Return mode can be :

- 0= switch into PARK mode
- 1= switch into INSTALLATION mode
- 2= switch into OPERATION mode with "auto-record" as the White List is empty

If the suppression of the White List not happens, a 0x01 or 0x02 error code is sent in the uplink frame "Reporting of downlink success or failure" (0x03) otherwise it will be a success code 0x00.

#### 4.2.2 Delete an ID from the White List

This 0x02 frame follow the uplink "Ask for White List modification" (0x02) enables to delete one ID from the White List.

0	1	2	3	4	5	6	7
Code	PAYLOAD						
0x02	The first pair of characters of the ID	The second pair of characters of the ID	The third pair of characters of the ID	The fourth pair of characters of the ID	X	X	X

If the suppression of the ID not happens, a 0x03 or 0x04 error code is sent in the uplink frame "Reporting of downlink success or failure" (0x03) otherwise it will be a success code 0x00. The product reboot to freeze the new White List and return to OPERATION mode. If after the suppression of the ID the White List is empty, the product will return to OPERATION mode with "auto-record".

#### 4.2.3 Add an ID into the White List or confirm White-List

This 0x03 frame can follow ether the uplink "Ask for a new ID" (0x01) or the uplink "Ask for White List modification" (0x02) and enables to add one ID in the White List:

0	1	2	3	4	5	6	7
Code	PAYLOAD						
0x03	White List confirmation	The first pair of characters of the ID	The second pair of characters of the ID	The third pair of characters of the ID	The fourth pair of characters of the ID	X	X

White List confirmation can be used only in INSTALLATION mode:

- 0x00 : the ID is memorized and a new uplink "Ask for a new ID" is sent. The White List is not confirmed and frozen.
- 0x01 : all the IDs are memorized in the White List. The White List is frozen by the reboot of the repeater. The repeater switch into OPERATION mode.

N.B: after the add of an ID if the White List is full (15 IDs provided), the White List will be confirmed and the repeater will turn into OPERATION mode automatically.

If the add of the ID not happens, a 0x05 or 0x06 error code is sent in the uplink frame "Reporting of downlink success or failure" (0x03) otherwise it will be a success code 0x00. The product reboot to freeze the new White List and return to OPERATION mode.

N.B: the new ID will be added at the first empty register available or at the end of the White List (register S380 to S394).

#### 4.2.4 Modify the Repeater configuration

This 0x04 frame follow the uplink "Ask for White List modification" (0x02) and enables to modify the repeater configuration:

0	1	2	3	4	5	6	7
Code	PAYLOAD						
0x04	S300	S303	S304	S306	X	X	X

Description of the frame:

- Byte 1: Change "Transmission period of the status frame" (S300) configuration
- Byte 2: Change "Number of repetitions" (S303) configuration
- Byte 3: Change "Duty cycle" (S304) configuration
- Byte 4: Change "Product mode" (S306) configuration

Refers to the 6.4 "Description of the registers" section to know the characteristics of each registers.

If one or several configuration are not done, a 0x10 to 0xF0 error code is sent in the uplink frame "Reporting of downlink success or failure" (0x03) otherwise it will be a success code 0x00. The repeater will reboot.



### 4.2.5 Freeze the list of devices repeated in "auto-record" mode into the White List

This 0x05 frame follow the uplink "Ask for White List modification" (0x02) and enables to freeze into the White List the IDs that are currently repeated in OPERATION with "auto-record" mode:

0	1	2	3	4	5	6	7
Code	PAYLOAD						
0x05	X	X	X	X	X	X	X

- If the White List is empty and there is one or several IDs currently repeated, a success code 0x00 is sent in the uplink frame "Reporting of downlink success or failure" (0x03) and the White List is frozen (register S380 to S394).
- If the White List is empty and there is no ID currently repeated, an error code 0x07 is sent in the uplink frame "Reporting of downlink success or failure" (0x03) and the Repeater stay in OPERATION with "auto-record" mode.
- If the White List is not empty, an error code 0x08 is sent in the uplink frame "Reporting of downlink success or failure" (0x03).

### 4.2.6 Downlink success or error code

Frame code of the corresponding downlink	Success/error code	Description
0x01,0x02,0x03,0x04,0x05	0x00	The action has been correctly realized
	0x0A	Uplink code is invalid
	0x0B	Hardware error, please contact adeunis support
	0x0C	Callback error
	0x0D	Generic error
0x01 "Suppress all IDs from White List"	0x01	White List already empty
	0x02	White List not erased
0x02 "Delete an ID from White List"	0x03	White List is empty, repeater switch into OPERATION with "auto-record" mode
	0x04	ID not found in the White List
0x03 "Add an ID into White List"	0x05	White List is full, "add an ID" not possible
	0x06	ID already existing in the White List
0x05 "Freeze the list of devices repeated in auto-record mode into the White List"	0x07	No ID repeated, repeater stay into OPERATION with "auto-record" mode
	0x08	A White List is already existing, use "Suppress all IDs from White List" frame before
Other DL	0x09	Invalid downlink
	0x0A to 0x0F	Reserved
0x04 "Modify Repeater configuration"	0x11	Error with S300 configuration
	0x12	Error with S303 configuration
	0x13	Error with S300, S303 configuration
	0x14	Error with S304 configuration
	0x15	Error with S300, S304 configuration
	0x16	Error with S303, S304 configuration
	0x17	Error with S300, S303, S304 configuration
	0x18	Error with S306 configuration
	0x19	Error with S300, S306 configuration
	0x1A	Error with S303, S306 configuration
	0x1B	Error with S300, S303, S306 configuration
	0x1C	Error with S304, S306 configuration
	0x1D	Error with S300, S304, S306 configuration
	0x1E	Error with S303, S304, S306 configuration
	0x1F	Error with S300, S303, S304, S306 configuration

EN

## 5. BATTERY REPLACEMENT AND START-UP OF THE DEVICE

### 5.1. Battery replacement

First, you have to open the casing using the cable gland as a lever.

Then, disconnect the old battery pack from the electronic board as shown in picture below and remove it:

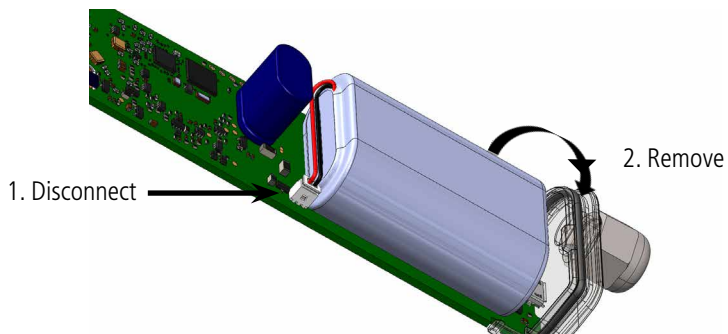

Now you can place and connect the new battery pack on the product.

Finally, close the casing following the instructions of next paragraph (6.2. Closing the casing).

Use the activation process describe in part Activating the repeater then you can see the following LED behavior.

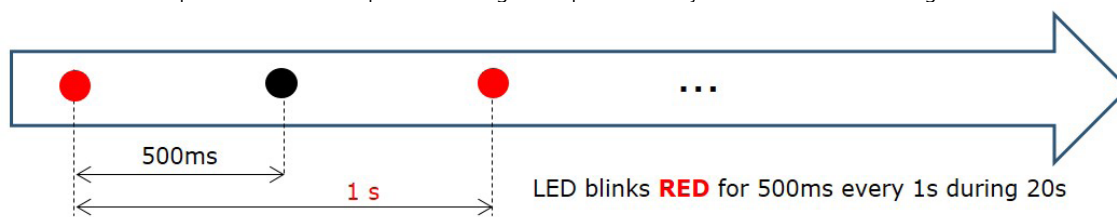

After that if the battery has enough energy the product goes to PARK mode in the other hand the product stays in DEAD mode.

EN

## 5.2. Closing the casing

Once previous stages have been carried out, you can close the casing of the Sigfox Repeater

Procedure:

1. Make sure that the seal is properly positioned on the base
2. Clip the electronic board onto the casing's base. Make sure that the fastening clip is properly locked into the board's fitting.
3. Insert the upper part of the casing. Inside this part there are guide rails for the board. Make sure that the board is properly positioned within these guides.
4. Once the board is in position, lower the upper cover and lock it onto the casing's base. Strong pressure will enable both parts to be clipped together and will enable protection level IP67 to be ensured.
5. Finish the assembly by locking the packing gland's nut in position

EN

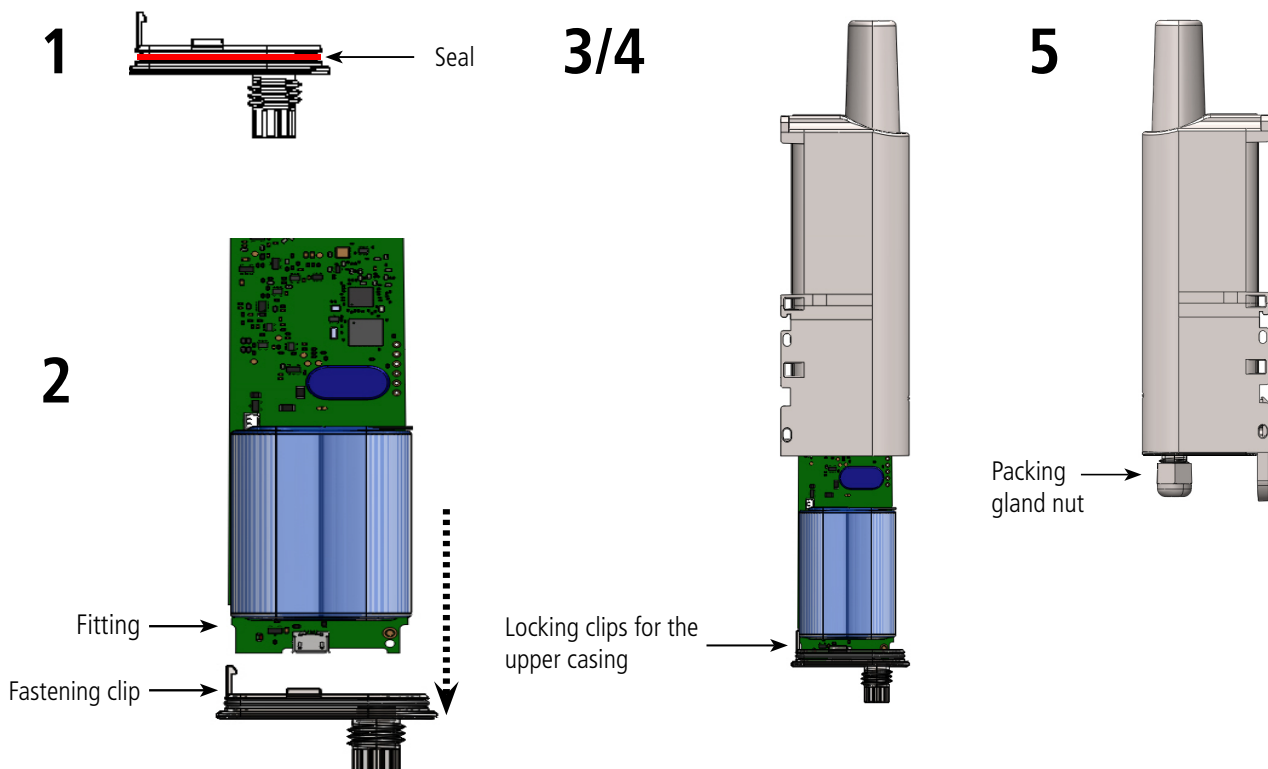

## 5.3. Starting up the product using a magnet

Once the product has been configured and its assembly has been finalized, the product is ready to be started up.

The start-up is carried out using a magnet which you place on the upper part of the product (cf. diagram). The magnet must be held in position for at least 6 seconds so as to confirm the start-up of the product. When the magnet is well detected, the green LED lights up for 1 second.

Once the Sigfox Repeater unit validates its start-up, it immediately transmits status frames followed by a data frame (according the defined periodicity).

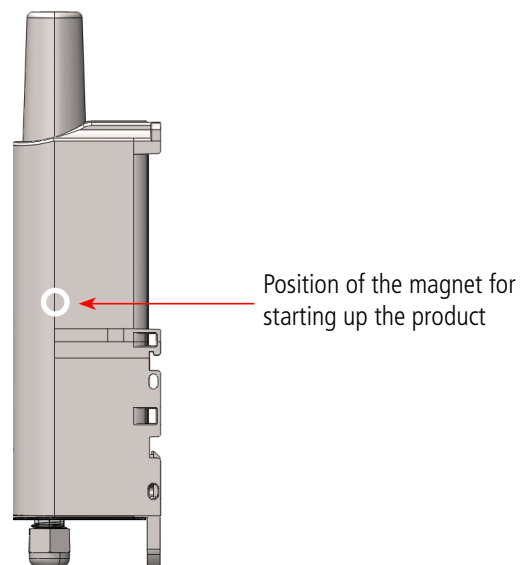

## 6. INSTALLATION AND USE

### 6.1. Correct positioning of the product

There are two key rules for optimizing radio ranges.

- The first one consists of positioning your product as high as possible.
- The second one consists of limiting the number of obstacles in order to avoid excessive attenuation of the radio wave.

EN

**Position:** To the extent possible, install the transmitter at a minimum height of 1.50 m and do not attach it to the wall.

**Obstacles:** Ideally, the product must be 20 cm away from any obstacle and, if possible, near an opening (the closer the obstacle is, the more the emitted power will be absorbed). All the materials encountered by a radio wave will attenuate it. Bear in mind that metal (metal cabinets, beams, etc.) and concrete (reinforced concrete, partitions, walls, etc.) are the most critical materials for the propagation of radio waves.

### 6.2. Types of fastenings

The product offers 3 fastening methods that enable numerous ways of positioning it depending on the environment where it has to be deployed.

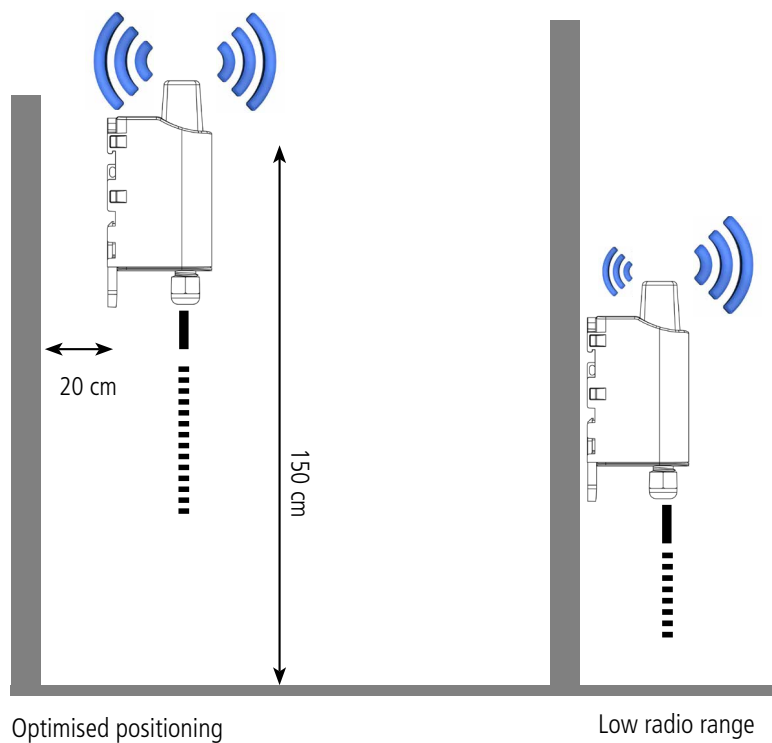

#### 6.2.1 Tube or mast fastenings

As explained in section 4.1, the best radio performance is achieved by positioning the product as high as possible.

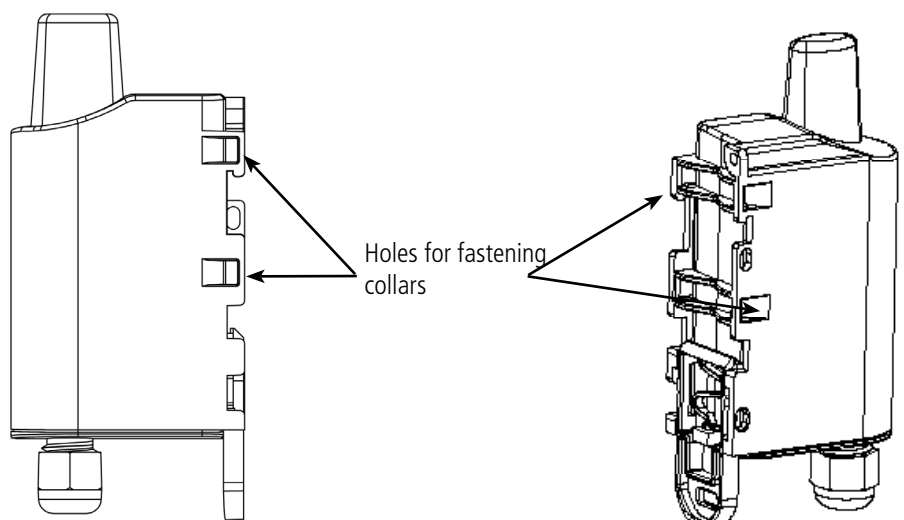

The fastening collar fastenings enable the product to be fastened on a mast or tube under completely safe conditions  
To optimise fastening onto a tube or mast, we recommend you remove the Rail-DIN locking/unlocking lever.

To remove it, pull the lever down until the locking pins are opposite a freed-up part and then remove the lever.

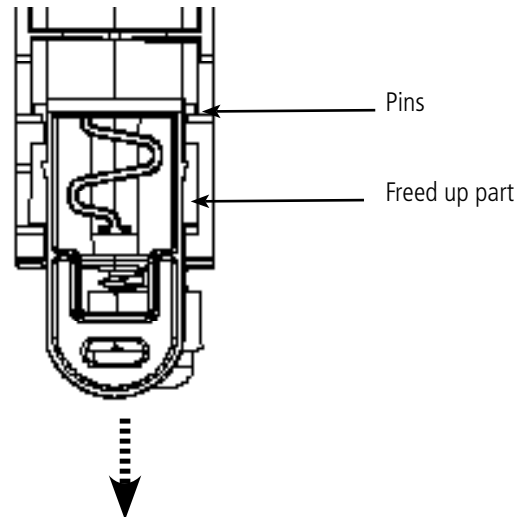

EN

### 6.2.2 Fixing with screws

The product is delivered with 2 CBLZ 2.2 x 19 mm screws and 2 SX4 wall plugs. Use these products or equivalent products in order to fasten your product onto any flat support.

Two positions may be selected: Laid flat or on its edge.

- Placing it on its edge enables the product to be placed at a distance from its support and helps achieve better propagation of the radio waves.
- If you opt for laying it flat, make sure you remove the Rail-DIN locking/unlocking lever, as explained above

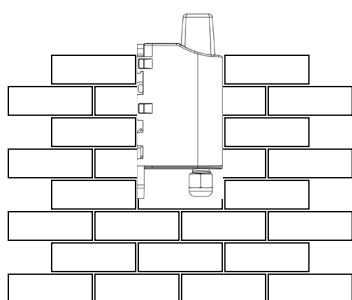
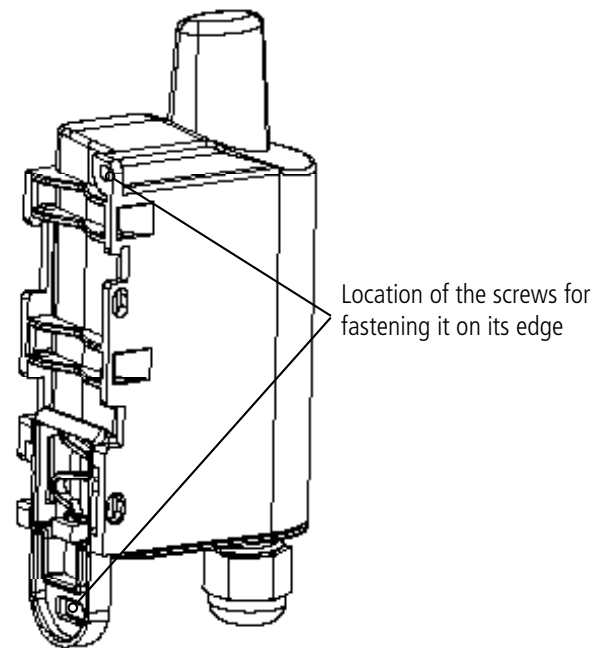
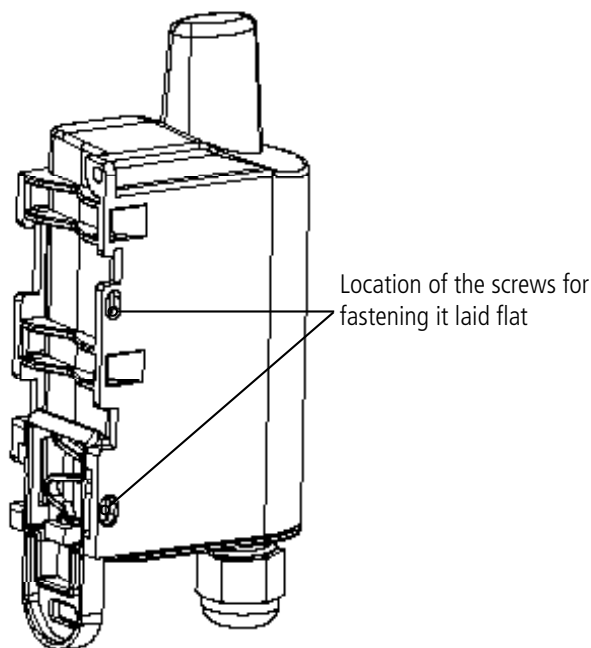

Fastening laid flat

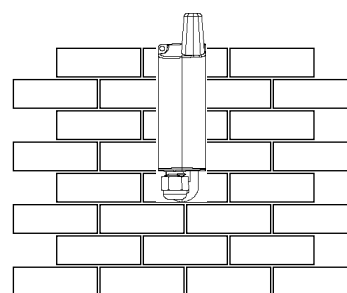

Fastening on its edge

### 6.2.3 DIN-Rail fixing

This system, integrated into the casing, enables the product unit to be fastened onto a standard 35 mm rail.

- To fit the casing, place the upper inserts on the rail and lower the product to clip it into position.
- To remove the product, pull the unlocking lever down and disengage the product from the rail.

EN

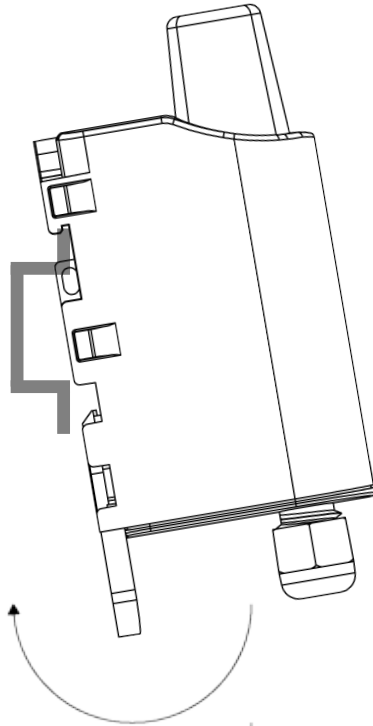

Locking onto the DIN-Rail

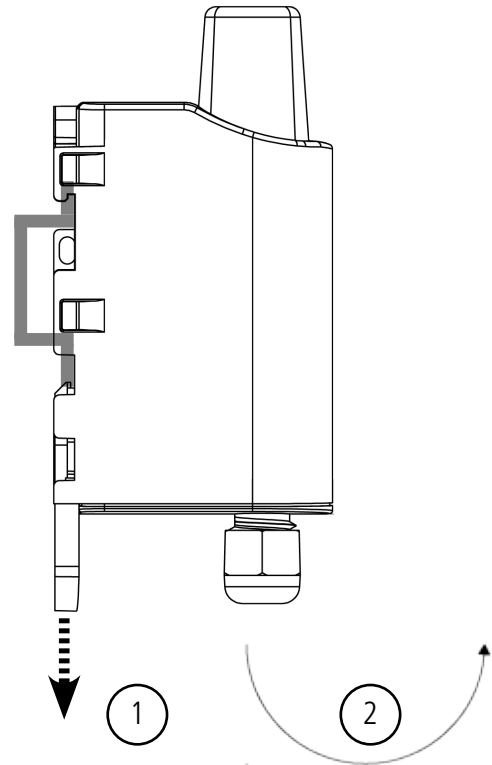

Unlocking

## 7. DOCUMENT HISTORY

User guide version	Contents
1.0.0	Document created
1.1.0	Update information
1.2.0	Update information
2.0.0	Update information
3.0.0	New release of the Repeater: - adding INSTALLATION mode - adding uplink and downlink to modify the White List or the repeater configuration remotely.

FR

# FRANCAIS

## INFORMATIONS

Information document	
<b>Titre</b>	Sigfox Repeater - Guide utilisateur
<b>Sous-titre</b>	Version 3.0.0
<b>Type de document</b>	Mise en oeuvre

Ce document s'applique aux produits suivants :

Nom	Référence	Version firmware
<b>Sigfox Repeater RC1</b>	ARF8168	V2.03.05

FR

## AVERTISSEMENT

Ce document et l'utilisation de toute information qu'il contient, est soumis à l'acceptation des termes et conditions Adeunis.

Adeunis ne donne aucune garantie sur l'exactitude ou l'exhaustivité du contenu de ce document et se réserve le droit d'apporter des modifications aux spécifications et descriptions de produit à tout moment sans préavis.

Adeunis se réserve tous les droits sur ce document et les informations qu'il contient. La reproduction, l'utilisation ou la divulgation à des tiers sans autorisation expresse est strictement interdite. Copyright © 2016, adeunis®.

adeunis® est une marque déposée dans les pays de l'UE et autres.

## SUPPORT TECHNIQUE

### Site web

Notre site Web contient de nombreuses informations utiles : informations sur les produits et accessoires, guides d'utilisation, logiciel de configuration et de documents techniques qui peuvent être accessibles 24h/24.

### Contact

Si vous avez des problèmes techniques ou ne pouvez pas trouver les informations requises dans les documents fournis, contactez notre support technique via notre site Web, rubrique « Support Technique ». Cela permet de s'assurer que votre demande soit traitée le plus rapidement possible.

### Informations utiles lorsque vous contactez notre support technique

Lorsque vous contactez le support technique merci de vous munir des informations suivantes :

- Type de produit
- Version du firmware (par exemple V1.0.0)
- Description claire de votre question ou de votre problème
- Vos coordonnées complètes



# Déclaration UE de Conformité

## Nous

adeunis  
283 rue LOUIS NEEL  
38920 Crolles, France  
04.76.92.01.62  
www.adeunis.com

**Déclarons que la DoC est délivrée sous notre seule responsabilité et fait partie du produit suivant :**

Modèle produit : Répéteur  
Références : ARF8168AA

**Objet de la déclaration :**

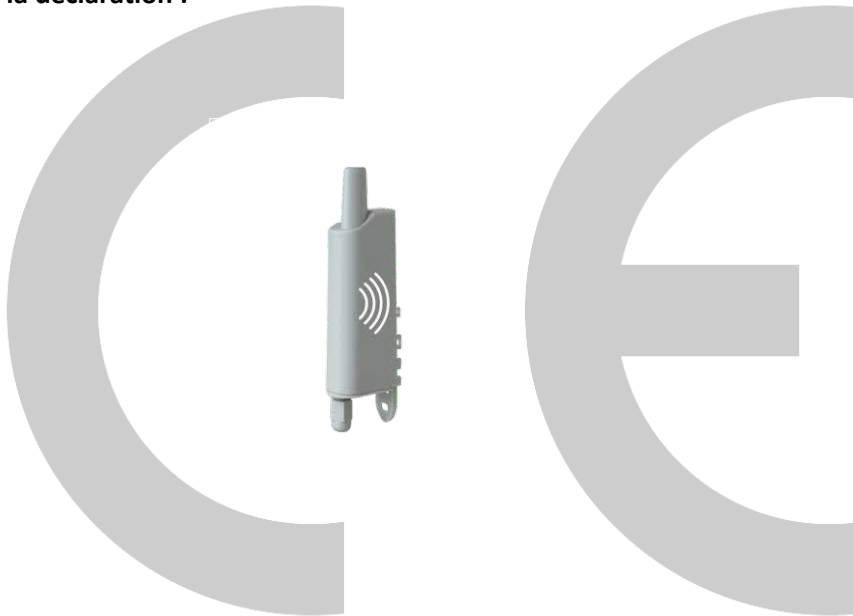

L'objet de la déclaration décrit ci-dessus est conforme à la législation d'harmonisation de l'Union applicable :

**Directive 2014/53/UE (RED)**

**Les normes harmonisées et les spécifications techniques suivantes ont été appliquées :**

<b>Titre :</b>	<b>Date du standard/spécification</b>
EN 300 220-2 V3.1.1	2017/02
EN 301 489-1 V2.1.1	2016/11
EN 301 489-3 V2.1.0	2016/09
EN 62368-1	2014
EN 62311	2008

18 Décembre 2017

Monnet Emmanuel, Responsable Certification

FR

## INTRODUCTION

Tous les droits de ce manuel sont la propriété exclusive de adeunis®. Tous droits réservés. La copie de ce manuel (sans l'autorisation écrite du propriétaire) par impression, copie, enregistrement ou par tout autre moyen, la traduction de ce manuel (complète ou partielle) pour toute autre langue, y compris tous les langages de programmation, en utilisant n'importe quel dispositif électrique, mécanique, magnétique, optique, manuel ou autres méthodes, est interdite.

adeunis® se réserve le droit de modifier les spécifications techniques ou des fonctions de ses produits, ou de cesser la fabrication de l'un de ses produits, ou d'interrompre le support technique de l'un de ses produits, sans aucune notification écrite et demande expresse de ses clients, et de s'assurer que les informations à leur disposition sont valables.

Les logiciels de configurations et programmes adeunis® sont disponibles gratuitement dans une version non modifiable. adeunis® ne peut accorder aucune garantie, y compris des garanties sur l'adéquation et l'applicabilité à un certain type d'applications. Dans aucun cas le fabricant, ou le distributeur d'un programme adeunis®, ne peut être tenu pour responsable pour tous les dommages éventuels causés par l'utilisation d'udit programme. Les noms des programmes ainsi que tous les droits d'auteur relatifs aux programmes sont la propriété exclusive de adeunis®. Tout transfert, octroi de licences à un tiers, crédit-bail, location, transport, copie, édition, traduction, modification dans un autre langage de programmation ou d'ingénierie inversée (retro-ingénierie) est interdit sans l'autorisation écrite et le consentement de adeunis®.

### **Adeunis**

283, rue Louis Néel  
38920 Crolles  
France

FR

## RECOMMANDATIONS ENVIRONNEMENTALES

Tous les matériaux d'emballage superflus ont été supprimés. Nous avons fait notre possible afin que l'emballage soit facilement séparable en trois types de matériaux : carton (boîte), polystyrène expansible (matériel tampon) et polyéthylène (sachets, feuille de protection en mousse). Votre appareil est composé de matériaux pouvant être recyclés et réutilisés s'il est démonté par une firme spécialisée. Veuillez observer les règlements locaux sur la manière de vous débarrasser des anciens matériaux d'emballage, des piles usagées et de votre ancien appareil.

## AVERTISSEMENTS

Valables pour les produits cités dans la déclaration de conformité.



Lire les instructions dans le manuel.



La sécurité procurée par ce produit n'est assurée que pour un usage conforme à sa destination. La maintenance ne peut être effectuée que par du personnel qualifié.



Risque d'explosion si la batterie est remplacée par un type incorrecte

Attention, ne pas installer l'équipement près d'une source de chaleur ou près d'une source d'humidité.

Attention, lorsque l'équipement est ouvert, ne pas réaliser d'opérations autres que celles prévues dans cette notice.



**Attention :** ne pas ouvrir le produit, risque de choc électrique.



**Attention :** pour votre sécurité, il est impératif qu'avant toute intervention technique sur l'équipement celui-ci soit mis hors tension.



**Attention :** pour votre sécurité, le circuit d'alimentation du produit doit être de type TBTS (très basse tension de sécurité) et doit être des sources à puissance limitée.



**Attention :** lorsque l'antenne est installée à l'extérieur, il est impératif de connecter l'écran du câble à la terre du bâtiment. Il est recommandé d'utiliser une protection contre la foudre. Le kit de protection choisi doit permettre une mise à la terre du câble coaxial (ex : parafoudre coaxial avec mise à la terre du câble à différents endroits au niveau de l'antenne en bas du pylône et à l'entrée, ou juste avant de pénétrer dans le local).

Il faut que le produit soit muni d'un dispositif de sectionnement pour pouvoir couper l'alimentation. Celui-ci doit être proche de l'équipement.

Tout branchement électrique du produit doit être muni d'un dispositif de protection contre les surcharges et les courts-circuits.

## RECOMMANDATIONS D'USAGE

- Avant d'utiliser le système, vérifiez si la tension d'alimentation figurant dans son manuel d'utilisation correspond à votre source. Dans la négative, consultez votre fournisseur.
- Placez l'appareil contre une surface plane, ferme et stable.
- L'appareil doit être installé à un emplacement suffisamment ventilé pour écarter tout risque d'échauffement interne et il ne doit pas être couvert avec des objets tels que journaux, nappes, rideaux, etc.
- L'antenne de l'appareil doit être dégagée et distante de toute matière conductrice de plus de 10 cm.
- L'appareil ne doit jamais être exposé à des sources de chaleur, telles que des appareils de chauffage.
- Ne pas placer l'appareil à proximité d'objets enflammés telles que des bougies allumées, chalumeaux, etc.
- L'appareil ne doit pas être exposé à des agents chimiques agressifs ou solvants susceptibles d'altérer la matière plastique ou de corroder les éléments métalliques.

### Élimination des déchets par les utilisateurs dans les ménages privés au sein de l'Union Européenne



Ce symbole sur le produit ou sur son emballage indique que ce produit ne doit pas être jeté avec vos autres ordures ménagères. Au lieu de cela, il est de votre responsabilité de vous débarrasser de vos déchets en les apportant à un point de collecte désigné pour le recyclage des appareils électriques et électroniques. La collecte et le recyclage séparés de vos déchets au moment de l'élimination contribueront à conserver les ressources naturelles et à garantir un recyclage respectueux de l'environnement et de la santé humaine. Pour plus d'informations sur le centre de recyclage le plus proche de votre domicile, contactez la mairie la plus proche, le service d'élimination des ordures ménagères ou le magasin où vous avez acheté le produit.



Ce symbole sur le produit ou sur son emballage indique l'utilisation d'une tension continue (DC)



Attention : Il y a un risque d'explosion si les batteries sont remplacées par une référence non correcte. Jeter les batteries suivant les instructions d'usages. Lors du changement des batteries, le produit doit être proprement et correctement remonté.



IMPORTANT pour la Suisse : l'annexe 4.10 du standard SR 814.013 doit être appliquée pour les batteries

# DEUTSCH

# Vorschriften

DE

## HAFTUNGSAUSSCHLUSS

Dieses Dokument und die Nutzung aller darin enthaltenen Informationen setzt das Einverständnis mit den Bestimmungen und Bedingungen von adeunis® voraus.

adeunis® übernimmt keine Garantie für die Richtigkeit oder Vollständigkeit des Inhalts dieses Dokuments und behält sich das Recht vor, jederzeit und ohne Vorankündigung Änderungen an den Produktspezifikationen und -beschreibungen vorzunehmen.

adeunis® behält sich alle Rechte an diesem Dokument und den darin enthaltenen Informationen vor. Die Vervielfältigung, Nutzung oder Weiterverbreitung an Dritte ohne ausdrückliche Genehmigung ist streng untersagt. Copyright © 2016, adeunis®.

adeunis® ist eine eingetragene Marke in den EU-Staaten und anderen Ländern.

## TECHNISCHER SUPPORT

### Website

Unsere Website enthält viele nützliche Informationen: Informationen zu Produkten und Zubehör, Benutzeranleitungen, Konfigurationssoftware und technische Dokumente, die rund um die Uhr abrufbar sind.

### E-Mail

Falls Sie technische Probleme haben oder nicht die benötigten Informationen in den bereitgestellten Dokumenten finden können, setzen Sie sich per website mit unserem technischen Support in Verbindung. Verwenden Auf diese Weise wird sichergestellt, dass Ihre Anfrage so schnell wie möglich bearbeitet wird.

### Nützliche Informationen bei Kontaktierung unseres technischen Supports

Wenn Sie unseren technischen Support kontaktieren, halten Sie bitte folgende Informationen bereit:

- Produkttyp
- Firmware-Version
- Klare Beschreibung Ihrer Frage oder Ihres Problems
- Ihre vollständigen Kontaktdaten

## VORBEMERKUNG

Alle Rechte an dieser Anleitung liegen ausschließlich bei . Alle Rechte vorbehalten. Die Vervielfältigung dieser Anleitung (ohne schriftliches Einverständnis des Eigentümers) mittels Drucken, Kopieren, Speichern oder in anderer Weise, die Übersetzung dieser Anleitung (vollständig oder teilweise) in jedwede Sprache, einschließlich aller Programmiersprachen, unter Verwendung jeglicher elektrischer, mechanischer, magnetischer, optischer, manueller Geräte oder anderer Methoden, ist untersagt.

adeunis® behält sich das Recht vor, ohne schriftliche Bekanntgabe und ohne ausdrückliches Verlangen seiner Kunden die technischen Spezifikationen oder Funktionen seiner Produkte zu ändern und sicherzustellen, dass die ihnen zur Verfügung gestellten Informationen gültig sind.

Die -Konfigurationssoftware und -programme adeunis® werden in einer unveränderlichen Version kostenlos bereitgestellt. adeunis® kann für einen bestimmten Typ von Anwendungen keinerlei Garantie übernehmen, auch keine Gewähr für deren Eignung und Verwendbarkeit. Der Hersteller oder Vertreiber eines -Programms kann auf keinen Fall für etwaige Schäden infolge der Nutzung dieses Programms haftbar gemacht werden. Die Namen der Programme sowie alle Urheberrechte im Zusammenhang mit den Programmen sind ausschließliches Eigentum von adeunis®. Jedwede(r) Übertragung, Lizenzierung an Dritte, Vermietung, Verleih, Überführung, Kopie, Bearbeitung, Übersetzung, Veränderung in einer anderen Programmiersprache oder Rückwärtsentwicklung (Reverse-Engineering) ohne die schriftliche Genehmigung und Zustimmung von ist untersagt.

### Adeunis

283, rue Louis Néel  
38920 Crolles  
Frankreich

### Website

[www.adeunis.com](http://www.adeunis.com)

DE

## UMWELTSCHUTZHINWEISE

Es wurden alle überflüssigen Verpackungsmaterialien vermieden. Wir haben uns bemüht, dass die Verpackung leicht in drei Materialarten getrennt werden kann: Pappe (Schachtel), expandiertes Polystyrol (Puffermaterial) und Polyethylen (Tüten, Schaumstoff-Schutzlage). Ihr Gerät besteht aus recycelbaren Materialien, die im Falle einer Demontage durch ein Fachunternehmen wiederverwendet werden können. Bitte beachten Sie die vor Ort geltenden Vorschriften zur Entsorgung der Verpackungsabfälle, verbrauchten Batterien und Ihres Altgeräts.

## WARNHINWEISE



Lesen Sie die Hinweise in dieser Anleitung.



Die Sicherheit dieses Produkts wird nur für eine bestimmungsgemäße Verwendung gewährleistet. Die Wartung darf nur von einer qualifizierten Person durchgeführt werden.



Explosionsgefahr, wenn die Batterie durch einen falschen Typ ersetzt wird

Achtung: Das Gerät nicht in der Nähe einer Wärme- oder Feuchtigkeitsquelle installieren.

Achtung: Bei Öffnung des Geräts keine anderen als die in dieser Anleitung vorgesehenen Vorgänge durchführen.



Achtung: Das Produkt nicht öffnen – Gefahr eines Stromschlags.



Achtung: Zu Ihrer Sicherheit muss vor jedem technischen Eingriff am Gerät dieses stromlos geschaltet werden.

Achtung: Zu Ihrer Sicherheit muss der Stromversorgungskreis des Produkts vom Typ SELV (Sicherheitskleinspannung) sein und es sich um Stromquellen mit begrenzter Leistung handeln.

Bitte beachten Sie: Wenn die Antenne draußen installiert ist, ist es notwendig, den Kabelschirm mit der Erdung des Gebäudes zu verbinden. Wir empfehlen den Blitzschutz. Der gewählte Schutzkit muss das Koaxialkabel wie geerdet haben (zB: Koaxial-Blitzableiter mit Erdung des Kabels an verschiedenen Stellen auf der Antenne an der Basis von Pylonen und am Eingang oder kurz vor dem Betreten der Räumlichkeiten).

Das Produkt muß mit einem Schaltmechanismus zum Abschalten des elektrischen Stroms ausgestattet werden, welche sich in der Nähe der Ausrüstung befinden muss. Jede elektrische Verbindung des Produktes muß mit einer Schutzvorrichtung gegen Spannungsspitzen und Kurzschlüsse ausgestattet werden.



## GEBRAUCHSHINWEISE

- Überprüfen Sie vor Benutzung des Systems, ob die in dessen Betriebsanleitung angegebene Versorgungsspannung mit Ihrer Stromquelle übereinstimmt. Falls nicht, wenden Sie sich an Ihren Lieferanten.
- Stellen Sie das Gerät auf eine ebene, feste und stabile Oberfläche.
- Das Gerät muss an einem ausreichend belüfteten Standort installiert werden, um jedes Risiko einer internen Überhitzung auszuschließen, und es darf nicht mit Objekten wie Zeitungen, Decken, Gardinen usw. abgedeckt werden.
- Das Gerät darf auf keinen Fall Hitzequellen wie Heizgeräten ausgesetzt werden.
- Stellen Sie das Gerät nicht in der Nähe brennender Gegenstände wie Kerzen, Lötbrennern, usw. auf.
- Das Gerät darf keinen aggressiven Chemikalien oder Lösungsmitteln ausgesetzt werden, die den Kunststoff angreifen oder die Metallteile korrodieren könnten.
- Das Terminal muss am Gürtel mit Hilfe eines dafür vorgesehenen Clips getragen werden.

## ENTSORGUNG VON ABFÄLLEN DURCH DIE NUTZER IN PRIVATHAUSHALTEN IN DER EUROPÄISCHEN UNION



Dieses Symbol auf dem Produkt oder auf seiner Verpackung bedeutet, dass dieses Produkt nicht mit anderem Hausmüll entsorgt werden darf. Stattdessen obliegt es Ihrer Verantwortung, Ihre Abfälle zu einer benannten Sammelstelle für die Wiederverwertung von Elektro- und Elektronikaltgeräten zu bringen. Getrenntes Sammeln und Recyceln bei der Entsorgung Ihrer Abfälle trägt zur Bewahrung der natürlichen Ressourcen und zu einer umweltverträglichen Wiederverwertung sowie zum Schutz der menschlichen Gesundheit bei. Für weitere Informationen zum nächstgelegenen Recyclingzentrum wenden Sie sich an das nächste Rathaus, den Entsorgungsdienst für Haushaltsabfälle oder das Geschäft, in dem Sie das Produkt gekauft haben.



Dieses Symbol auf dem devode Gerät oder seiner Verpackung bedeutet den Gebrauch einer Gleichstrom-Spannung.



Achtung: Es besteht Explosionsgefahr, wenn die Batterien durch einen falschen Typ ersetzt werden. Entsorgen Sie die Batterien gemäß den Gebrauchshinweisen. Beim Wechsel der Batterien muss das Produkt wieder richtig und ordnungsgemäß zusammengesetzt werden.



WICHTIG für die Schweiz: Für die Batterien muss Anhang 4.10 der Norm SR 814.013 Anwendung finden.