

MAKO 5G DOME

Low Profile 4x4 4G/5G MiMo

Up to 6 x 6 MiMo Dual Band WiFi

Optional GPS/GNSS Active Antenna 26dB LNA

The L[G]M[X]M4[X]-6-60[-24-58] range has been designed to provide 4x4 4G/5G MiMo performance from 617-960/1710-6000MHz in a robust low profile package. The flexible platform allows the main elements to be combined with a number of other functions including GPS/GNSS and up to 6x6 MiMo WiFi 2.4/5.0GHz.

The antenna is designed to be panel mounted and can be fitted on a conductive or non-conductive panel. Supplied with integrated flame retardant RG174 cables (Compliant to UNECE 118.01 and EN45545-2) and a halogen free flame retardant radome the antenna is suitable for many environments and applications.

The LGM variants have an integrated GPS/GNSS module supporting GPS, Glonass, Galileo, QZSS and Compass with 26dB LNA gain. This GPS module features advanced filtering for LTE B13/14 designed to minimise potential in band interference.

The antenna is available with a black or white radome which meets IK10 for vandal resistance and IP69K for ingress protection.



Technical Drawing

LGMHM4-6-60-24-58 Shown

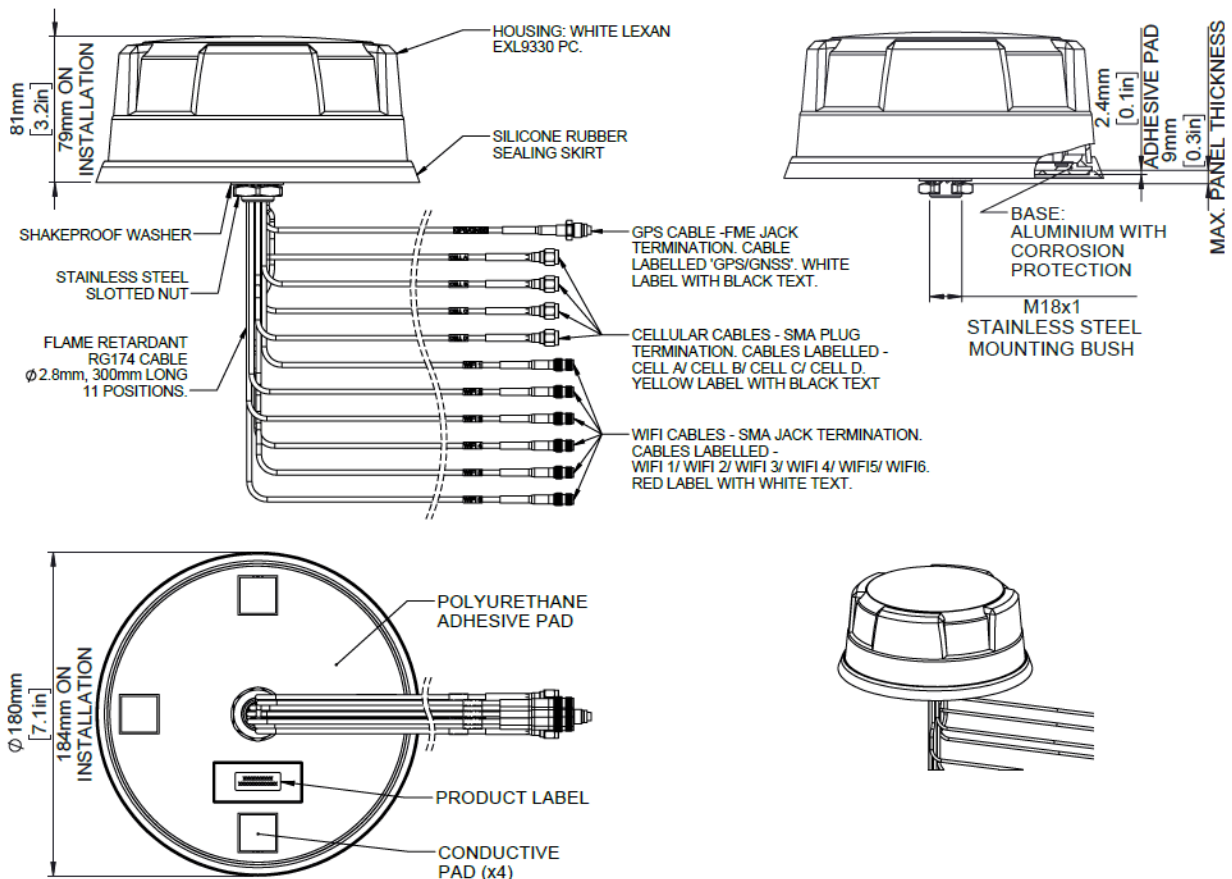

Part No.	LGMHM4-6-60-24-58	LGMHM4B-6-60-24-58	LGMQM4-6-60-24-58	LGMQM4B-6-60-24-58
----------	-------------------	--------------------	-------------------	--------------------

Electrical Data

Frequency Range (MHz)	4G/5G Elements	4x 617-960 / 1710-6000
	WiFi Elements	6x 2.4/4.9-6GHz 4x 2.4/4.9-6GHz
Peak Gain: Isotropic : (dBi)	4G/5G Elements	617-960MHz 1710-3800MHz 4900-6000MHz
		4 8 9
	WiFi Elements	2.4 GHz 7.2 GHz
		9 9
Typical Efficiency **	4G/5G Elements	617-960MHz 1710-3800MHz 4900-6000MHz
		>50% >75% >85%
	WiFi Elements	>70%
Isolation ***	4G/5G Elements	>10dB
	Wifi Elements	>12dB
Correlation Co-efficient	4G/5G Elements	< 0.2
	WiFi Elements	<0.1
Nominal Impedance		50Ω

GPS/GNSS Data

Frequency Range (MHz)	1562-1612
VSWR	<2.0:1 ± 4MHz
Gain: LNA	26dB
Out of band rejection	>40dB (@ > +/- 100MHz f)
Typical Noise Figure	-2.7dB
Notch Filter rejection @787MHz	23dBm
Operating Voltage	3 - 5V DC
Typical Current (mA)	15

Mechanical Data

Dimensions (mm)	Height	80 (3.1")
	Diameter	180 (7.1")
Operating Temp (°C)		-40° / +80°C (-40° / +176°F)
Colour	White	Black
	White	Black
Ingress Protection		IP69K

Mounting Data

Mounting type	Panel mount
Max panel thickness (mm)	7 (0.27")
Mounting hole (mm)	19 (3/4")

Cable Data

All Cables	Type	RG174 -FR (UN ECE118.01 Compliant)
	Diameter (mm)	2.8 (0.1")
	Length (m)	0.3 (1')

Terminations

4G/5G	SMA (m)
WiFi	SMA (f)
GPS/GNSS	FME (f)

4x4 MiMo 4G/5G Dome Combination Antenna Range MAKO 5G DOME

www.ime.de

PANORAMA ANTENNAS

Part No.

LGMTM4-6-60-24-58 LGMTM4B-6-60-24-58 LGMDM4-6-60-24-58 LGMDM4B-6-60-24-58

Electrical Data

Frequency Range (MHz)	4G/5G Elements	4x 617-960 / 1710-6000		
	WiFi Elements	3x 2.4/4.9-6GHz	2x 2.4/4.9-6GHz	
Peak Gain: Isotropic : (dBi)		617-960MHz	4	
	4G/5G Elements	1710-3800MHz	8	
		4900-6000MHz	9	
	WiFi Elements	2.4 GHz	9	
Typical Efficiency **		7.2 GHz	9	
		617-960MHz	>50%	
	4G/5G Elements	1710-3800MHz	>75%	
		4900-6000MHz	>85%	
Isolation ***	WiFi Elements		>70%	
	4G/5G Elements		>10dB	
	WiFi Elements		>12dB	
Correlation Co-efficient	4G/5G Elements		< 0.2	
	WiFi Elements		<0.1	
Nominal Impedance			50Ω	

GPS/GNSS Data

Frequency Range (MHz)	1562-1612		
VSWR	<2.0:1 ± 4MHz		-
Gain: LNA	26dB		
Out of band rejection	>40dB (@ > +/- 100MHz f)		
Typical Noise Figure	-2.7dB		
Notch Filter rejection	23dBm		
Operating Voltage	3 - 5V DC		
Typical Current (mA)	15		

Mechanical Data

Dimensions (mm)	Height	80 (3.1")		
	Diameter	180 (7.1")		
Operating Temp	-40° / +80°C (-40° / +176°F)			
Colour	White	Black	White	Black
Ingress Protection	IP69K			

Mounting Data

Mounting type	Panel mount
Max panel thickness (mm)	7 (0.27")
Mounting hole (mm)	19 (3/4")

Cable Data

All Cables	Type	RG174 -FR (UN ECE118.01 Compliant)
	Diameter (mm)	2.8 (0.1")
	Length (m)	0.3 (1')

Terminations

4G/5G	SMA (m)
WiFi	SMA (f)
GPS/GNSS	FME (f)

Part No.		LGMM4-6-60	LGMM4B-6-60	LPMM4-6-60	LPMM4B-6-60
Electrical Data					
Frequency Range (MHz)	4G/5G Elements	4x 617-960 / 1710-6000			
		617-960MHz	4		
Peak Gain: Isotropic : (dBi)†	4G/5G Elements	1710-3800MHz	8		
		4900-6000MHz	9		
		617-960MHz	>50%		
Typical Efficiency **	4G/5G Elements	1710-3800MHz	>75%		
		4900-6000MHz	>85%		
Isolation ***	4G/5G Elements		>10dB		
Correlation Co-efficient	4G/5G Elements		< 0.2		
Nominal Impedance			50Ω		
GPS/GNSS Data					
Frequency Range (MHz)		1562-1612	-		
VSWR		<2.0:1 ± 4MHz	-		
Gain: LNA		26dB	-		
Out of band rejection		>40dB (@ > +/- 100MHz f)	-		
Typical Noise Figure		-2.7dB	-		
Notch Filter rejection @787MHz		23dBm	-		
Operating Voltage		3 - 5V DC	-		
Typical Current (mA)		15	-		
Mechanical Data					
Dimensions (mm)	Height	80 (3.1")			
	Diameter	180 (7.1")			
Operating Temp		-40° / +80°C (-40° / +176°F)			
Colour		White	Black	White	Black
Ingress Protection		IP69K			
Mounting Data					
Mounting type		Panel mount			
Max panel thickness (mm)		7 (0.27")			
Mounting hole (mm)		19 (3/4")			
Cable Data					
	Type	RG174 -FR (UN ECE118.01 Compliant)			
All Cables	Diameter (mm)	2.8 (0.1")			
	Length (m)	0.3 (1')			
Terminations					
4G/5G		SMA (m)			
GPS/GNSS		FME (f)	-		

**Typical efficiency shown for single element of relevant type simulated in CST Microwave Studio on 600x600mm (23.6"x23.6") ground plane excluding cable loss.

*** Isolation shown is worst case across all element pairings measured on 600x600mm (23.6"x23.6") ground plane with 0.5m (1'5") of Cable.

† Typical peak gain shown for single element of relevant type simulated in CST Microwave Studio on 600x600mm (23.6"x23.6") ground plane excluding cable loss.

4x4 MiMo 4G/5G Dome Combination Antenna Range MAKO 5G DOME

www.ime.de

PANORAMA ANTENNAS

Part No.		LPMM4-6-60-24-58	LPMM4B-6-60-24-58	
Electrical Data				
Frequency Range (MHz)	4G/5G Elements	4x 617-960 / 1710-6000		
	WiFi Elements	2x 2.4/4.9-6GHz		
Peak Gain: Isotropic : (dBi)	617-960MHz	4		
	4G/5G Elements	1710-3800MHz	8	
	4900-6000MHz	9		
		2.4 GHz	9	
	WiFi Elements	7.2 GHz	9	
		617-960MHz	>50%	
Typical Efficiency **	4G/5G Elements	1710-3800MHz	>75%	
	4900-6000MHz	>85%		
		WiFi Elements	>70%	
Isolation ***	4G/5G Elements	>10dB		
	WiFi Elements	>12dB		
Correlation Co-efficient	4G/5G Elements	< 0.2		
	WiFi Elements	<0.1		
Nominal Impedance	50Ω			
Mechanical Data				
Dimensions (mm)	Height	80 (3.1")		
	Diameter	180 (7.1")		
Operating Temp	-40° / +80°C (-40° / +176°F)			
Colour	White	Black		
Ingress Protection	IP69K			
Mounting Data				
Mounting type	Panel mount			
Max panel thickness (mm)	7 (0.27")			
Mounting hole (mm)	19 (3/4")			
Cable Data				
All Cables	Type	RG174 -FR (UN ECE118.01 Compliant)		
	Diameter (mm)	2.8 (0.1")		
	Length (m)	0.3 (1')		
Terminations				
4G/5G	SMA (m)			
GPS/GNSS	FME (f)	-		

Electrical Data - Cell

Typical VSWR - 4G/5G Elements*

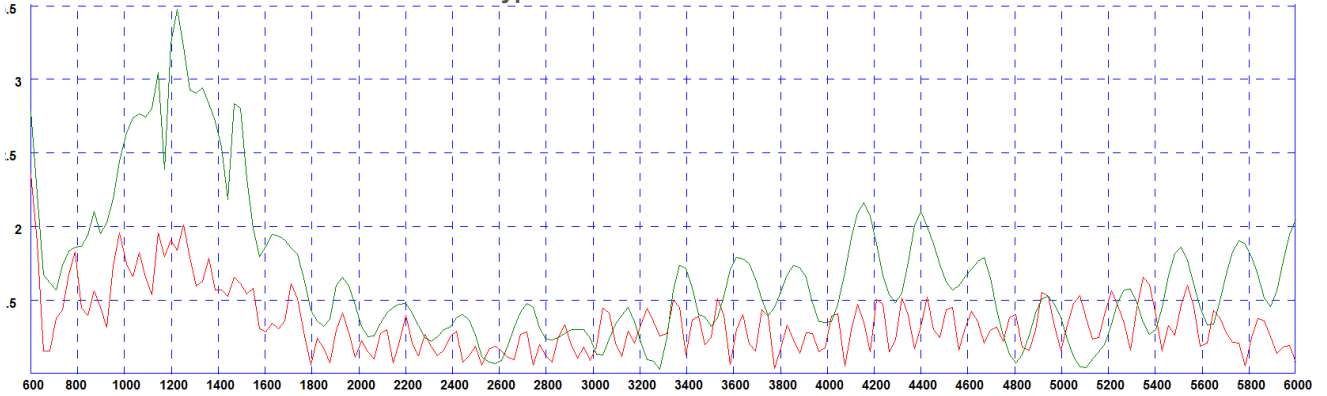

* Green Trace measured with 0.5m (1.5') of RG174 cable Red Trace measured with 5m(17') of CS32 Cable both on a 600x600mm (2'x2') groundplane

Typical Isolation - 4G/5G Elements*

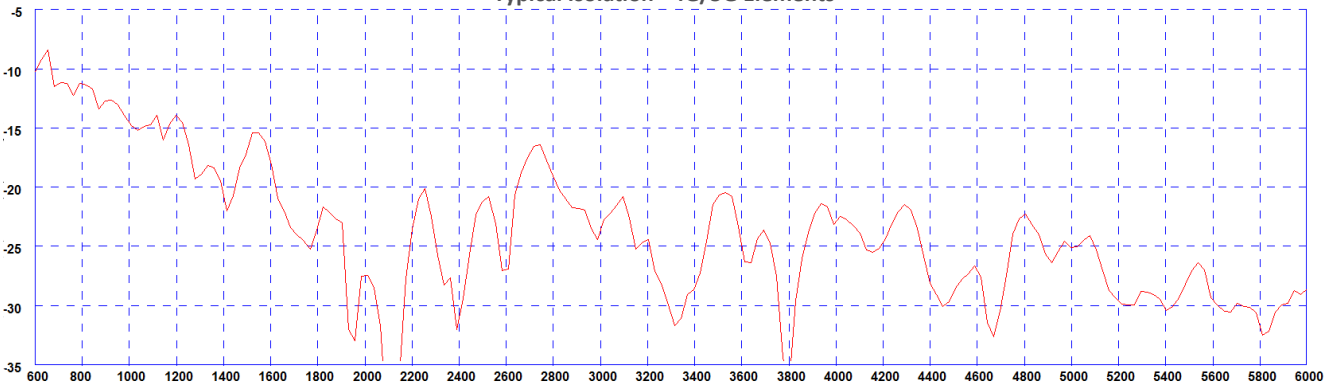

* measured with 0.5m (1.5') of RG174 cable on a 600x600mm (2'x2') groundplane

Typical VSWR - WiFi Elements*

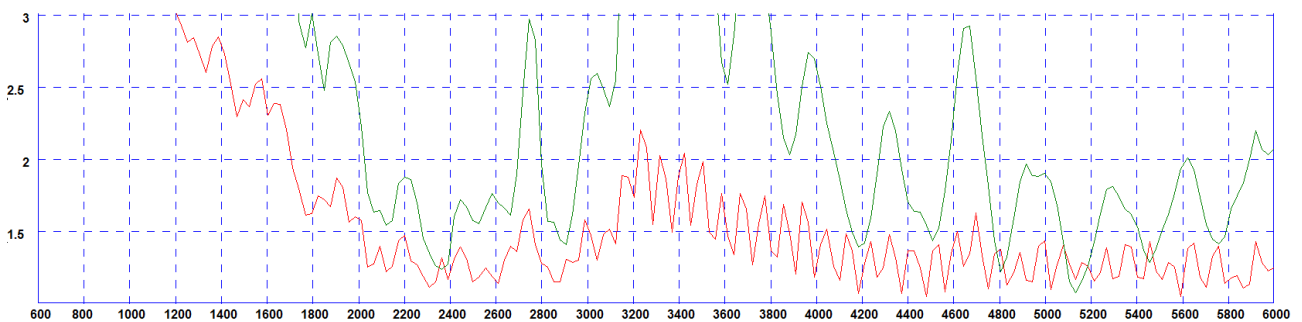

* Green Trace measured with 0.5m (1.5') of RG174 cable Red Trace measured with 5m(17') of CS32 Cable both on a 600x600mm (2'x2') groundplane

Typical Efficiency- 4G/5G Elements*

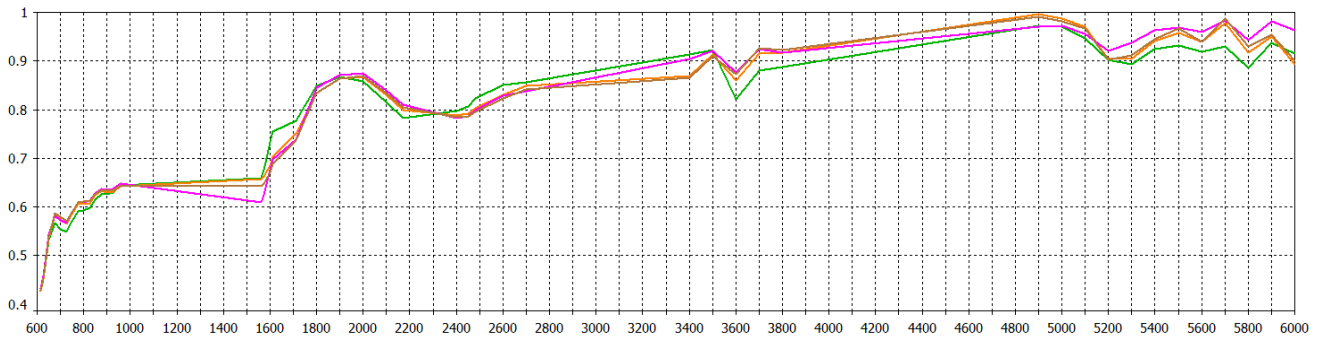

* Efficiency modelled with CST Microwave Studio with antenna mounted on 600x600mm (2'x2') ground plane and and ignores cable losses

Typical Peak Gain - 4G/5G Elements*

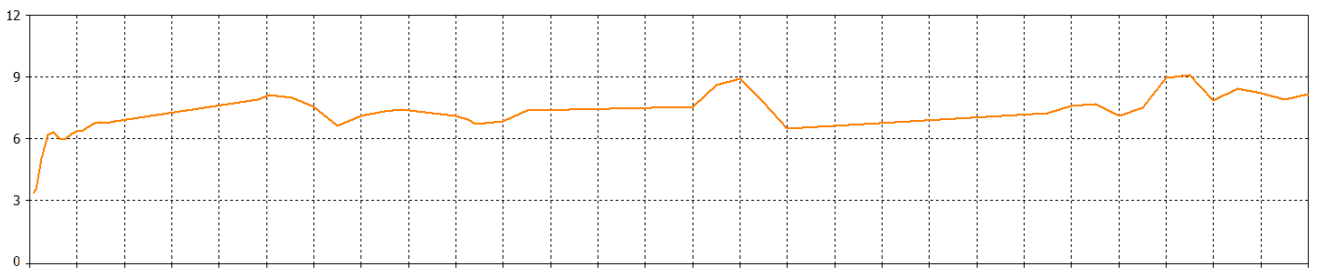

*Swept peak gain modelled with one element fed in CST Microwave Studio on a 600x600mm (2'x2') ground plane excluding cable loss

Typical Efficiency - WiFi Elements*



* Efficiency modelled for 4x4 MiMo Wifi version with CST Microwave Studio with antenna mounted on 600x600mm (2'x2') ground plane and and ignores cable losses

Typical Swept Peak Gain - WiFi Elements*

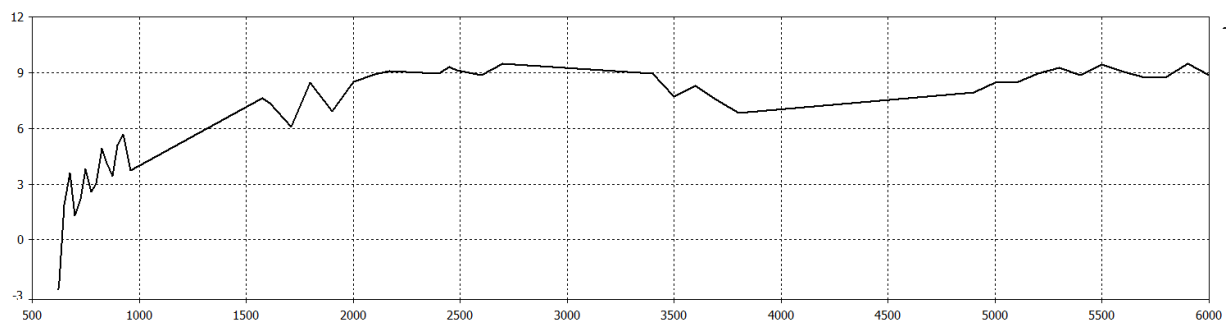

*Swept peak gain modelled with one element fed in CST Microwave Studio on a 600x600mm (2'x2') ground plane excluding cable loss

4G/5G Pattern Data

Typical 3D Pattern LTE Elements Side 617MHz

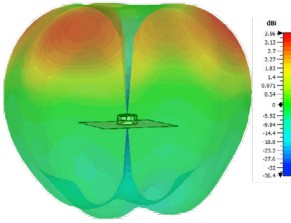

Typical 3D Pattern - LTE Elements Top 617MHz

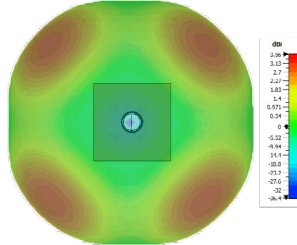

Typical 3D Pattern LTE Elements Side 700MHz

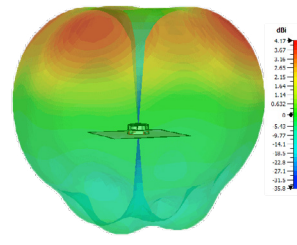

Typical 3D Pattern LTE Elements Top 700MHz

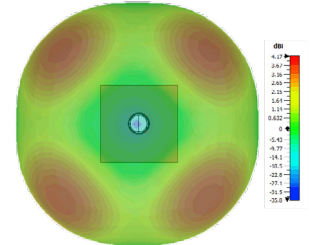

Typical 3D Pattern LTE Elements Side 800MHz

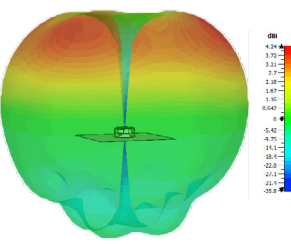

Typical 3D Pattern - LTE Elements Top 800MHz

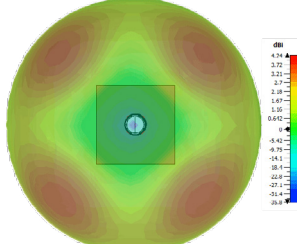

Typical 3D Pattern LTE Elements Side 1800MHz

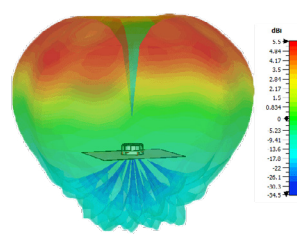

Typical 3D Pattern LTE Elements Top 1800MHz

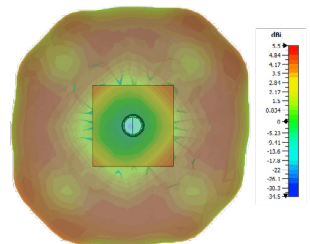

Typical 3D Pattern LTE Elements Side 2100MHz

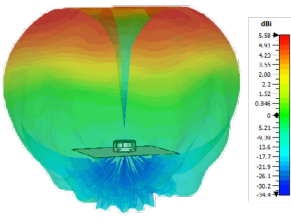

Typical 3D Pattern - LTE Elements Top 2100MHz

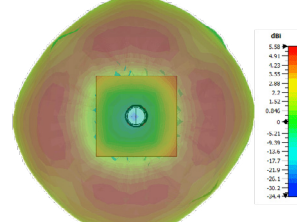

Typical 3D Pattern LTE Elements Side 2600MHz

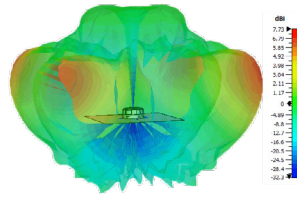

Typical 3D Pattern LTE Elements Top 2600MHz

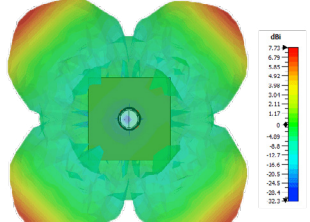

Typical 3D Pattern LTE Elements Side 3600MHz

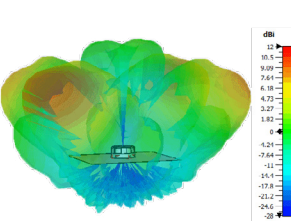

Typical 3D Pattern -LTE Elements Top 3600MHz

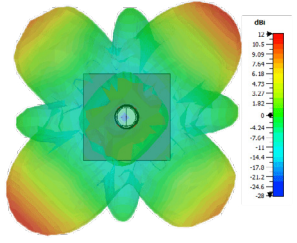

Typical 3D Pattern LTE Elements Side 5400MHz

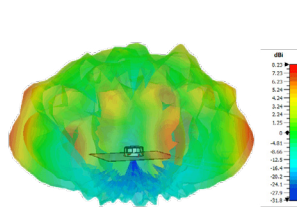

Typical 3D Pattern LTE Elements Top 5400MHz

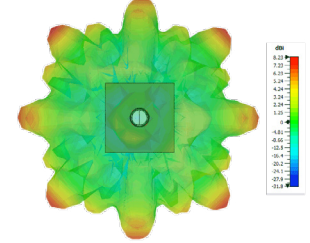

*Patterns are LGMQM4-6-60-24-58 modelled in CST Microwave Studio on a 600x600mm(2'x2') ground plane with all elements of each type fed.

WiFi Pattern Data

Typical 3D Pattern WiFi Elements Side 2450MHz

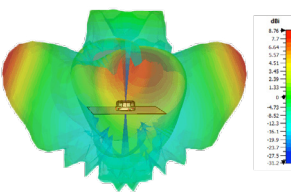

Typical 3D Pattern - WiFi Elements Top 2450MHz

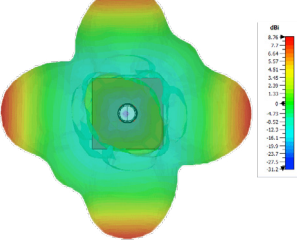

Typical 3D Pattern WiFi Elements Side 5400MHz

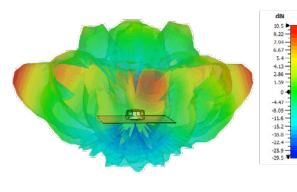

Typical 3D Pattern WiFi Elements Top 5400MHz

