

Home2Net

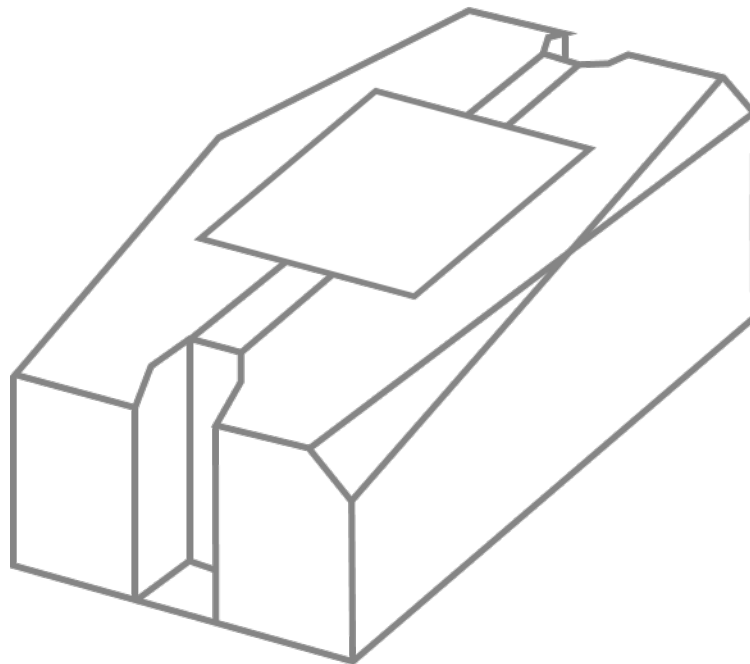

User Manual

EL3VT2

table of contents

1 General Information.....	4
1.1 Intended use and Disclaimer.....	4
1.2 Battery regulation and disposal.....	5
1.3 Certificate: EU Declaration of conformity.....	6
1.4 Sigfox radio network.....	7
1.5 IP69K protection class.....	9
1.6 About this manual.....	9
1.7 Used symbols.....	9
2 Description of the ELOC3 solution.....	10
2.1 System description.....	10
2.2 Device Description: ELVT2.....	13
Features.....	13
Functional Description & Specifications.....	14
2.4 h2n Track-it®.....	17
3 Installation and Registration of the ELOC3.....	18
3.1 First Activation of the ELOC3.....	18
3.2 Attachment of the ELOC3.....	19
Attachment with screws, no external connections.....	20
Attachment with screws, with external connections.....	21
Attachment with screws, without external connections.....	22
3.3 Maintenance.....	23
3.4 Attachment of the EL3VT2.....	23
3.5 Account and Device Registration to h2n Track-it®.....	24
Create a new Account.....	24
Register a Device to your Account.....	25
4 Operation and handling: h2n-track-it®.....	29

Impressum

Home2Net GmbH

Im Haslet 42

93086 Wörth | Donau

Germany

Tel.: +49 (9482) 89990-20

info@h2n.io

www.h2n.io

Disclaimer

The names used, trade names or product names and other designations may be protected by law even without special designation (e.g. as trademarks).

Home2Net GmbH does not assume any liability or warranty for their free usability. Great care has been taken in the compilation of illustrations and texts.

Nevertheless, errors cannot be excluded. The compilation is made without guarantee.

© Home2Net GmbH

All rights, including photomechanical rights, reserved.

Rendition and storage in electronic storage media, are reserved by Home2Net GmbH. A commercial use or passing on of the texts used in this product, drawings and photos are not allowed. The manual may not be used without prior written consent, neither partially nor completely reproduced, stored or in any form or with any medium are transmitted, can be reproduced or translated.

1 General Information

Thank you for choosing an ELOC3 from Home2Net GmbH!

The ELOC3 is equipped with a batteries based on lithium-ion technology. The innovative and compact system is easy to be installed and requires little space. If you have any technical questions, simply contact our service at:

support@h2.io

1.1 Intended use and Disclaimer

The ELOC3 is a very robust device which withstands strong mechanical influences as well as high temperature fluctuations. Please read this manual carefully for proper installation and handling of the device. Incorrect installation may cause a danger to the user or third parties. In addition, damage to the device and other property may occur. Moreover, the ELOC3 may only be used for its intended purpose.

In case of improper use of the device, the manufacturer is not liable for any resulting damage. Modifications to the ELOC3 are prohibited. Any misuse or modifications will void the manufacturer's warranty, guarantee and general liability. The installer must observe local laws and regulations.

1.2 Battery regulation and disposal

In connection with the sale of batteries or the supply of equipment containing batteries, the Seller is obliged to advise you of the following: You are required by law to return used batteries as an end user. You may return batteries free of charge after use to the Seller or to the designated collection points (e.g. municipal collection points or retailers).



The crossed-out dustbin symbol means that the battery must not be disposed of with household waste.

Technology: CR123A Lithium Mangan Dioxide

An empty battery is indicated in the h2n Track-it® cloud when the battery voltage drops below 2.4 volts.

CERTIFICATE

EU Declaration of conformity

Certificate Number 20180901

Date of Issue: 5. September 2018

Holder of Certificate:

home2net GmbH
Im Haslet 42
93086 Wörth a. d. Donau

Manufacturer:

home2net GmbH
Im Haslet 42
93086 Wörth a. d. Donau

Type/Model Name:

Eloc 3

Directive/s:

Radio Equipment (RE)
Direktive (2014/53/EU)

Standards:

EN 301489-1 V2.1.1
EN 301489-3 V1.6.1

This declaration of conformity is issued under the sole responsibility of the manufacturer.

The certificate is issued after testing of the named product/s and/or audit of the technical documentation and confirms that the tested product complies with the essential protection requirements of the mentioned directives on a voluntary basis.

5. September 2018

Date



Signature

CE After preparation of the necessary technical documentation as well as the conformity declaration the required marking can be affixed to the product.

1.4 Sigfox radio network

The ELOC3 is Sigfox Ready certified. The purchase of an ELOC3 automatically includes a limited service package for the use of the Sigfox network. The Sigfox LPWAN radio network is set up by the French telecommunications company Sigfox. It is a Low Power Wide Area Network, which enables the wireless connection of low-energy devices, such as smart devices or battery-powered sensors, to the Internet. The devices send small amounts of data at fixed intervals to a base station. The base station then forwards the message to the receiver's database. To date (as of 2019), 60 countries and regions are covered by the Sigfox network. An overview of the areas covered can be found at:

- <https://www.sigfox.com/en/coverage>

If there is no Sigfox network in your region, you can contact Sigfox at

- <https://www.sigfox.com/en/coverage/become-so>

to become a Sigfox operator.

Sigfox uses an ultra narrow band radio system. A long-range signal in the SRD (short-range device) band is used (868 megahertz in Europe) which also penetrates buildings and infrastructure. One main advantage of this network is that the user does not need any SIM cards or roaming.

General information of Radio Configuration (RC) Zones:

- Radio Configuration 1 (RC1) covering Europe, Oman and South Africa
- Radio Configuration 2 (RC2) covering North America and Brasil
- Radio Configuration 3 (RC3) covering Japan
- Radio Configuration 4 (RC4) covering South America, Australia, New Zealand, Singapore, Taiwan
- Radio Configuration 5 (RC5) covering South Korea



QF_585

Sigfox Ready™ Certificate

P_013F_CD8E_01

Congratulations home2net GmbH, the following product is now Sigfox Ready™ certified:



DEVICE COMMERCIAL NAME:	ELOC3
DEVICE MODEL NAME:	ELOC
RADIO CONFIGURATION:	RC1
TEST REPORT:	60213560-001
DEVICE UPLINK RADIATION CLASS:	1u
CERTIFICATION DATE:	10/04/2019
SIGFOX CREDENTIALS M NUMBER:	M_0043_E597_01 and M_001A_E56F_01
SIGFOX REFERENCE:	BUIL-453
SIGFOX FEATURES:	
DOWNLINK	✓
PAYLOAD ENCRYPTED	✗
MONARCH	✗

This certificate is valid for this product only. Any change to the certified product is to be reported to Sigfox as it may lead to a renewal of the Sigfox Ready™ certification. The Sigfox Ready™ logo must be used in respect of Sigfox branding guidelines.



1.5 IP69K protection class



The ELOC3 complies with the IP69K protection class. This protection class has been designed for high-pressure jet cleaning at high temperatures. The code number "6" stands for the Protection against the penetration of dust, the "9" for protection for high-pressure cleaning at a small distance and the "K" for the high temperature of the water used (hot water). Originally, it was intended for vehicles as protection against the ingress of foreign bodies such as dust or dirt and hot jet water.

The device can therefore be used in all conceivable operating conditions without getting damaged or being unusable.

1.6 About this manual

Read this manual carefully. It contains important information about the installation and operation of the ELOC3. Pay particular attention to the instructions for safe use. Home2Net GmbH is not liable for damage caused by failure to follow these instructions. These instructions are part of the product. They apply exclusively to the ELOC3 of Home2Net GmbH. Keep the instructions and pass them on to the successor if the operator changes. The installer and the operator must always have access to these instructions. The installer must be familiar with these instructions and follow them.

1.7 Used symbols

	Warning: Please pay attention to avoid damages or injuries
	Important information

2 Description of the ELOC3 solution

This chapter describes the ELOC3 device and the back-end system and is intended to give a general understanding of the components.



For installation instructions, refer to Chapter 3.

2.1 System description

The ELOC3 is a rugged battery powered locator to track objects, vehicles and equipment. Due to its extremely long-lasting batteries, a typical life cycle of 10 years is achieved with one locating / day. The innovative design of the ELOC3 combines extremely low quiescent current with modern sensor and radio technology, which can be adapted to a wide range of requirements by means of configurable operating modes. In the sensor monitor version, external signals and sensors can also be integrated. The internal sensors detect

- I. acceleration
- II. shock
- III. temperature
- IV. illumination and
- V. tilt and rotation.

The cloud platform h2n Track-it[®] provides the user with a complete system consisting of sensors and application platform that leaves nothing to be desired and can be seamlessly connected to existing systems via REST-API and message forwarding. The platform allows the configuration of the devices, supports location and alerting via SMS and emails. By using the Sigfox LPWAN technology, the user does not need any SIM cards or roaming, the entire administration of operating parameters and roaming is controlled by the h2n cloud application. The following Figure gives an overview of the ELOC3 concept.

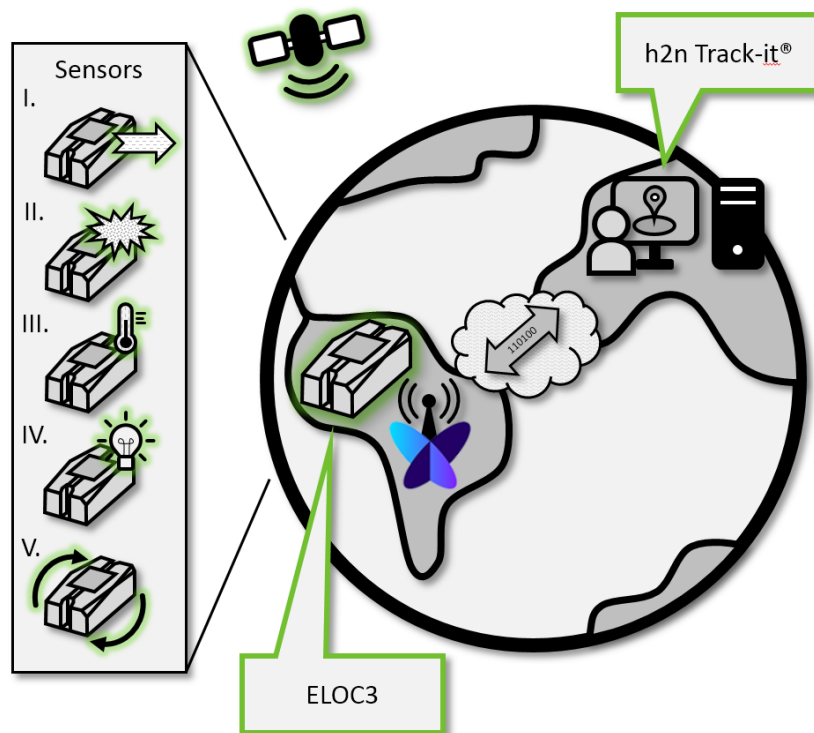

In order to ensure a most accurate tracking, the device waits until at least 5 satellites have been reached. If this state is not reached after a maximum of 40 seconds, the waiting process is aborted and the previously determined position, even if they are inaccurate, is used. If no positioning can be carried out, an error telegram is sent, which can be displayed in the h2n Track-it® cloud.

The accuracy with which the position of the device is determined via GPS depends on the power supply of the device. The ELOC3 can be powered by a battery or an external power supply. The following table gives an estimate of the resulting tracking accuracy.

Power Supply	Tracking accuracy
External	2.5 m
Battery	20 m



Please note, that GPS and Sigfox are different signals: The Sigfox signal can travel through walls and ceilings. GPS needs a visual connection to the satellites. Therefore, it is recommended to place the label facing up.

Depending on the desired application, specially designed devices were developed. Therefore, six different models are currently available. A uniform designation is used for each model. The basic principle of these model types is basically the same, they differ mainly in the availability of sensors and other functions. For further information, please see ???

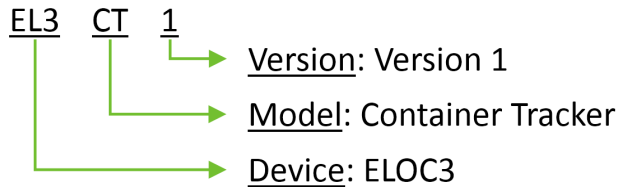

- EL3AM1 (Access Monitor)
- EL3BT2 (Boat Tracker)
- EL3CT1 (Container Tracker)
- EL3ET1 (Equipment Tracker)
- EL3IS1 (Impact Sensor)
- EL3VT2 (Vehicle Tracker)

Depending on the type, there are two different versions with regard to power supply and sensor technology. The device can have a pure battery supply with internal sensors. In addition, the device can have external connections, which guarantee the power supply as well as the connection of external sensors. According to the type, the device has a maximum of five external connections:

Color	Function	Range
Brown	GND	Ground
Red	Power	8...28V
Grey	Input 1	0...25V
Blue	Input 2	0...25V
Green	Input 3	0...25V

2.2 Device Description: ELVT2

The EL3VT2 is a heavy duty Sigfox tracking sensor for vehicle applications. Its ultra low power design allows battery life of many years from internal batteries and full tracking applications when external supply is present. EL3VT2 has a built in GPS / GLONASS / GALILEO system to locate vehicles in the field complemented by a Temperature sensor and an operating hours counter. External supply voltage and up to 3 additional voltage inputs can be measured periodically and sent to Cloud. With its integrated operating hours meter the EL3VT2 can count the vehicles operating hours while external supply is present. While at rest the behavior of EL3VT2 is controlled by an internal timer to send periodic messages and sensor values. With its wide temperature range and rugged design it is built for heavy duty applications in logistics, construction and agriculture.

Features

<p>Sensor technology and Localization</p> <ul style="list-style-type: none"> • Built in sensors for <u>orientation</u>, <u>rotation</u>, and <u>temperature</u> • Ultra low power motion sensor to activate the device with fully automatic motion detection • Hardware timer to activate the device for periodic radio messages at 30nA • Immediate radio messages when motion is detected and at end of motion • periodic radio messages when external supply is present / removed • Geofencing for motion monitoring <p>Hardware and Battery</p> <ul style="list-style-type: none"> • <u>IP69</u> rugged housing • <u>-20 ... +55 °C</u> outdoor temperature range • Battery life 5 – 10 years (depending on configuration) • Anti-Jamming, Multi-tone active interference canceler 	<p>Communication</p> <ul style="list-style-type: none"> • Built-in <u>Sigfox</u> Radio at 868.13 MHz with integrated antenna. RZ1 radio zone support <ul style="list-style-type: none"> ◦ No SIM card is needed • Multi-GNSS engine for <u>GPS</u>, <u>GLONASS</u> and <u>GALILEO</u> • Integrated patch antenna • EASY™, advanced AGPS technology allows ultra fast acquisition • 99 acquisition channels, 33 tracking channels • Quick position fix even at indoor signal levels with low power consumption • Built-in LNA for better sensitivity <ul style="list-style-type: none"> ◦ 165dBm@Tracking ◦ 148dBm@Acquisition • <u>h2n Track-it</u>® for monitoring and alerts <ul style="list-style-type: none"> ◦ alarm via SMS and email possible • JSON based data interface to existing software systems
--	--

Functional Description & Specifications

EL3VT2 will be activated by an external supply voltage and send its position data and temperature periodically via the Sigfox radio connection. When external supply is removed, an additional telegram is send containing position and operating hours of the device. Without external supply, the device is activated once per day by an internal timer and it will send position, temperature and orientation data to the Cloud. Once per day the device will request a configuration data packet from the Cloud to adjust configuration settings of the device. Motion sensitivity and timing can be adjusted over the Cloud once every 28 hours.

Absolute maximum ratings

Description	Min	Max	Unit
Storage Temperature	-40	70	°C
Maximum Shock		200	g
Humidity	5	100	%

Operational ratings

Description	Value
Sigfox radio zone	RZ1
Radio output power	+14 dB m
Motion activation sensitivity (configurable through Cloud)	4 samples 0,25g at 12 Hz
Motion inactive conditions (configurable through Cloud)	70 samples 0,25g at 12 Hz
Motion mode cycle time (configurable through Cloud)	Configurable, default 30 min
Timer Mode periodic data (Temp, Orientation, Rotation, Battery voltage)	Configurable form 2h to 24h
Timer Mode periodic position data	Configurable 24h default
Operating Temperature	-20..55 °C
Battery life (with 1 hour of motion per week) at 25 °C	3 years
IP code	IP69 (EN60529)
mounting	M4 screw or cable tie
weight	180g
Dimensions (Length, Width, Height)	101x51x33 mm

The device is not powered while shipped to avoid radio transmissions during shipping and especially on airplanes. To enable the device simply hold a magnet over the device label and the device will be activated and stay activated for the whole lifetime.

Timing Specifications

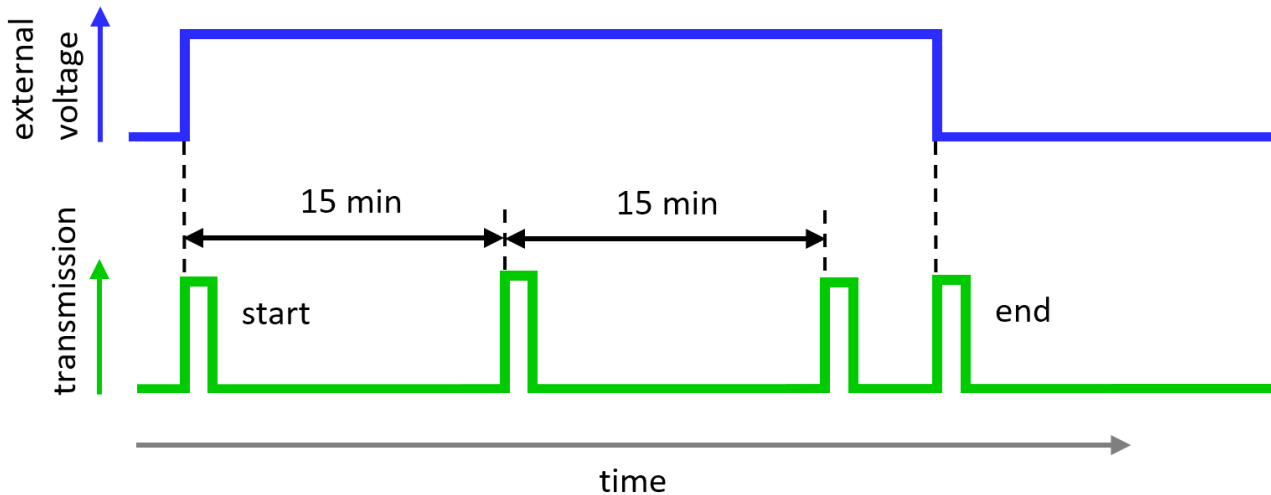

External supply is detected when the voltage is minimum 8 volts. The device will start sending its first data packet immediately after external voltage is supplied and will then send periodic data packets with a default timing of 15 minutes. When the external supply is removed, a special end of external supply packet is sent to ensure that the last position of the device is captured. All setup configurations can be changed once per day when the device checks for a configuration change with a special protocol packet. While operating under external supply, the device will send position data every 15 minutes and external input voltages and operating hours approximately every 45 minutes. While not in external supply mode, the device will be controlled by an internal timer which will turn the device on every 2 hours and will check configurations to send keep alive messages every 6 hours. The behavior is set by default to transmit Temperature, Operating hours and Battery voltage every 3 times which equals to 6 hours. Once per Day the device will also send its location data and request a new configuration from the Cloud server. Timing of these messages can also be changed with the cloud configuration. Operating hours are sent every 15 minutes when external supply is present and at when external supply is removed.

	<i>operating mode</i>
--	-----------------------

Sensor	Timer	Motion detected	End of Motion	configuration
Timing	24h (*1)	30 min (*1)		Every 28h
Temperature	-	-		Every 28h
Battery voltage	-	-	-	Every 28h
Orientation	24h (*1)	30 min (*1)	yes	
Rotation	24h (*1)	30 min (*1)	yes	

(*1) configurable by user



2.3 h2n Track-it®

With the powerful h2n Track-it® Cloud portal a user can monitor and track all ELOC3 Sensors and other h2n Track-it® Cloud connected devices in one central web application.

Link: <https://app-track-it.h2n.io>

Anyone can simply create a user account, register and manage his devices. The h2n Track-it® Cloud service is generating a map with symbols for all registered user devices which makes it easy to track and monitor any mix of sensors. The user can enable a variety of alerts and create multiple geo-fences per device or a definable group of devices. Dynamic grouping of the registered sensors can be organized and managed by each user separately. Setting email alerts and geo-fences allow close monitoring and tracking of devices even when you are not online. Smart icons for each type of sensor to quickly check by only looking at a the device icons on the map. Tracking and logging of historic data make h2n Track-it® a comprehensive solution for many industries and use cases. For more instructions please see the chapter 3 and chapter 4.

Features

- | | |
|--|---|
| <ul style="list-style-type: none">• Map oriented tracking and status display for any device or group of devices• Dynamic device organization and grouping by user specified hierarchy• Unlimited geo-fences with email and SMS alerting• Configurable alerts for any device sensor values or status changes.• Graphical display of any device sensor values.• Historic sensor values and trend analysis• Rest API to interface other databases or services | <ul style="list-style-type: none">• Transfer devices to any other users or allow other users to simultaneously use you devices• Web application works with any html5 compatible browser on any system.• Message queue for unlimited scalability and fast response time• Add virtual devices like weather data for any specific geolocation• Control your devices by setting individual configurations and download through the sigfox network |
|--|---|

3 Installation and Registration of the ELOC3

This chapter describes the procedure for installing the system. It explains the activation and attachment of the EL3CT1 and how to register the device in the h2n Track-it® portal.

3.1 First Activation of the ELOC3

All ELOC3 devices are switched off during storage and distribution in order to not consume energy. Depending on the model, there are two ways to switch on the devices.

1. battery-operated devices are switched on once using a magnet. The devices then remain permanently switched on and can no longer be switched off. The devices run for several years until the internal battery is completely discharged.

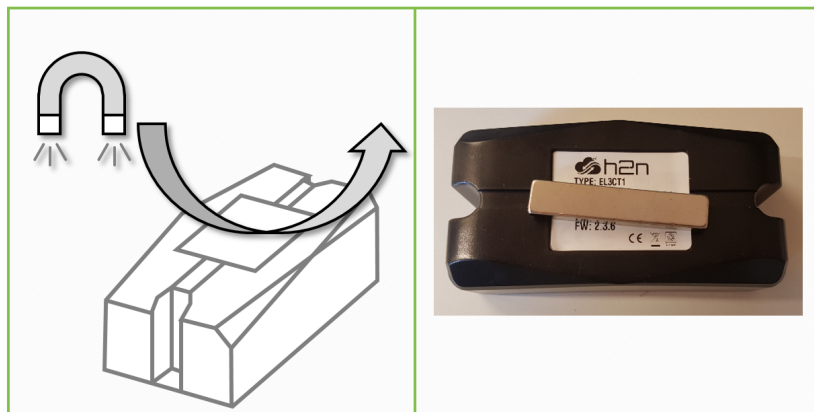

2. Devices with an external power supply are automatically switched on the first time they are connected to an external power supply and the internal battery remains on until it is exhausted. It is not intended to switch off the internal batteries.

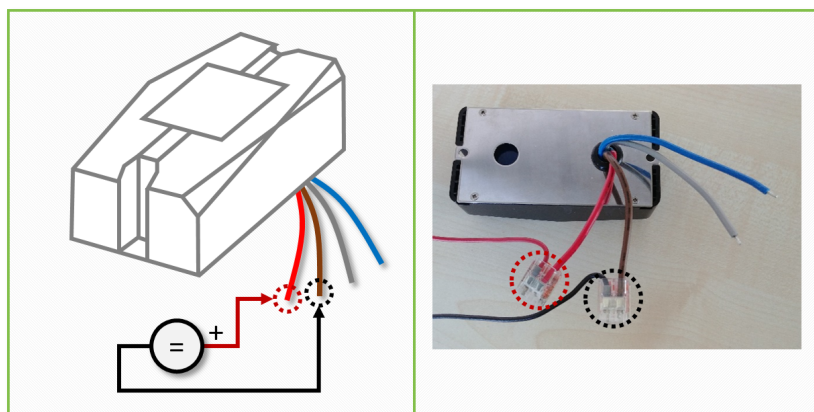

3.2 Attachment of the ELOC3

Due to its special design, the device can be mounted either with two M4 screws or cable ties. When mounting, observe the specifications in the following Figure.

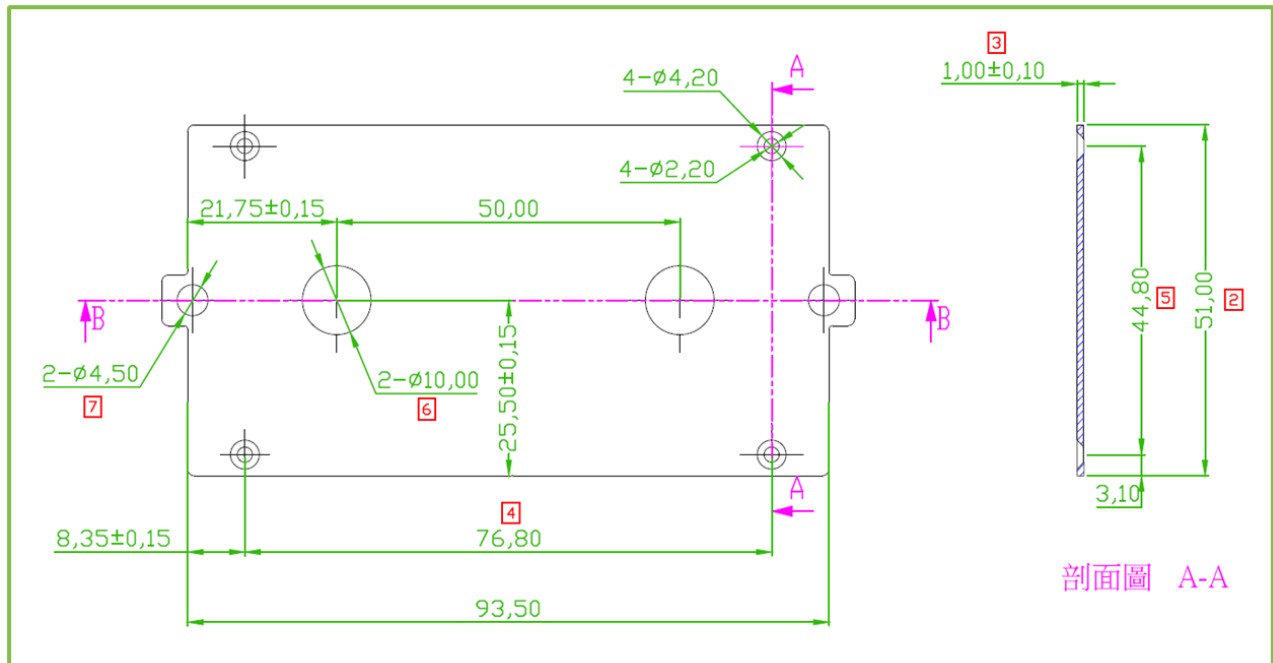

Please ensure that the device is firmly mounted so that it cannot fall off even under high mechanical loads and thus lead to material damage or personal injury. Especially when mounting on moving parts, it is advisable to mount them indoors, as long as the GPS availability is sufficient. Please pay particular attention to Chapter 3.4.



For the application on moving parts with high mechanical loads and accelerations, the use of screws instead of cable ties is suggested. If special anti-theft protection is required, shear bolts should be used.





In order to get the best possible GPS reception, it is recommended

- ... to place the label facing up. Ideally, the device should have a clear view to the sky.
- ... to **not** place the device behind mirrored (metallized) windows.

Attachment with screws, no external connections

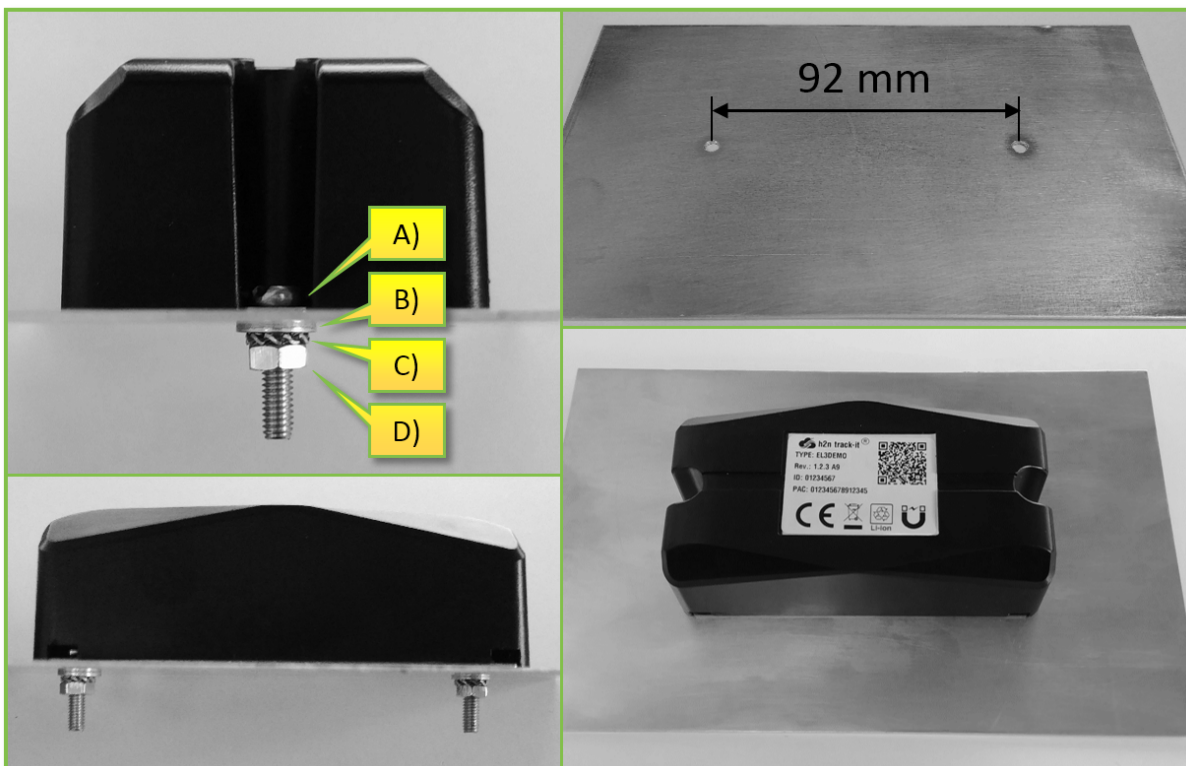
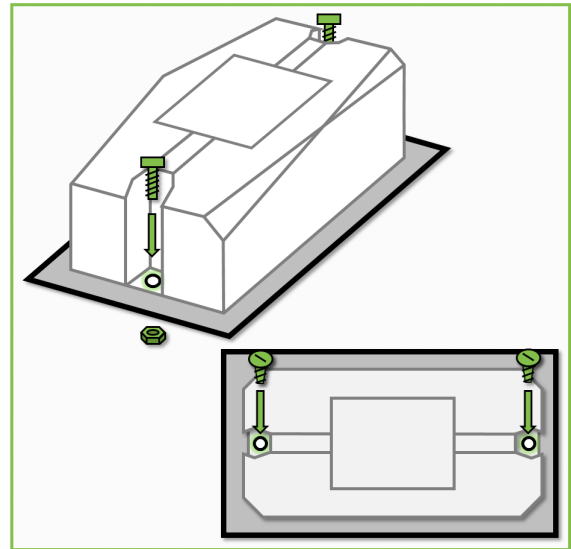
To attach the device to the target with screws, two M4 screws can be used, which provide the greatest possible stability. The ELOC3 is equipped with two 4.5 mm holes for this purpose. Before attaching the device, make sure that the mounting surface is clean and without any irregularities. Drill two 4.5 mm holes in the mounting target at a distance of 92 mm. Be sure to maintain the distance accurately to avoid mechanical damage when attaching. Also make sure that the drilled holes are cleaned and that no unevenness has occurred. Use two M4 screws, see **A)**, for the fixation. Insert the screws through the holes provided and fix them with a nut, see **D)**.



 Note, that the device may be exposed to high mechanical loads. For the highest possible stability, the use of washers and crown rings, see **B)** and **C)**, is recommended.

Attachment with screws, with external connections

If your ELOC3 has external connectors, you will need to drill an additional 10 mm diameter hole in the target surface. Before attaching the device, make sure that the mounting surface is clean and without any irregularities. Remove burrs and sharp edges to avoid damaging the insulation of the cables. When installing the unit, follow the instructions and notes in the previous example (Attachment with screws, no external connections).

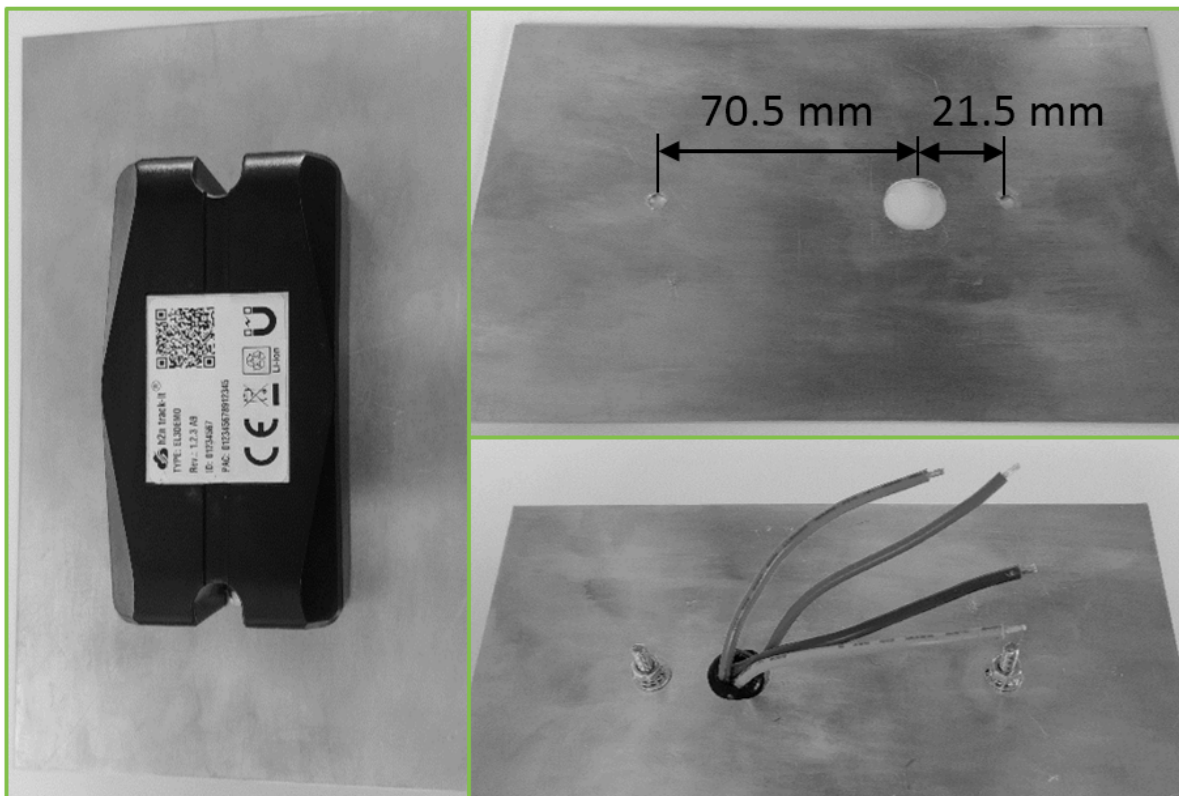
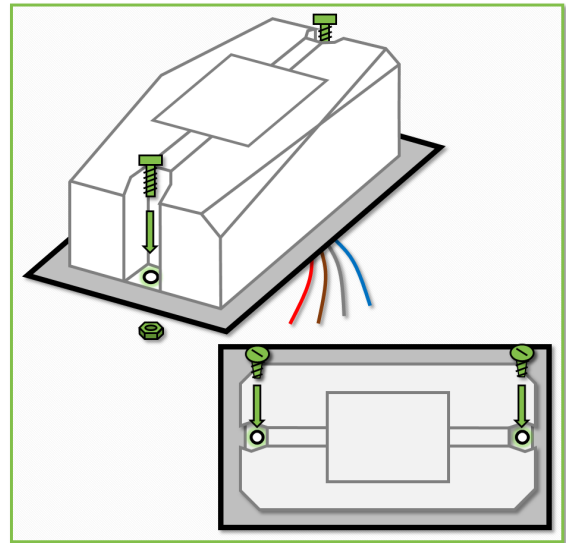

Note, that the device may be exposed to high mechanical loads. For the highest possible stability, the use of washers and crown rings, is recommended.

Attachment with screws, without external connections

Besides the attachment of the ELOC3 with screws, it is also possible to attach it with cable ties so that holes do not necessarily have to be drilled in the mounting target. Before attaching the device, make sure that the mounting surface is clean and without any irregularities. The device is provided with 55 mm joints for mounting, through which the cable tie can be led. Note, that at least 260 mm long cable ties are required (regardless of the target object).

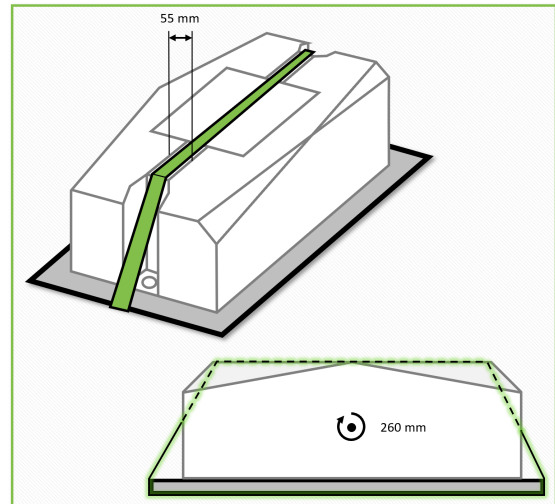

The use of cable ties is not recommended if the device is exposed to high mechanical loads during operation.

3.3 Attachment of the EL3VT2

The EL3VT2 can be attached to a vehicle in various places. It is important to ensure that it is not mounted on the outside of the vehicle, as it may fall off or influence other road users. It should also be positioned as high up as possible to ensure good GPS reception. In the following, two specific examples and instructions for installation are given

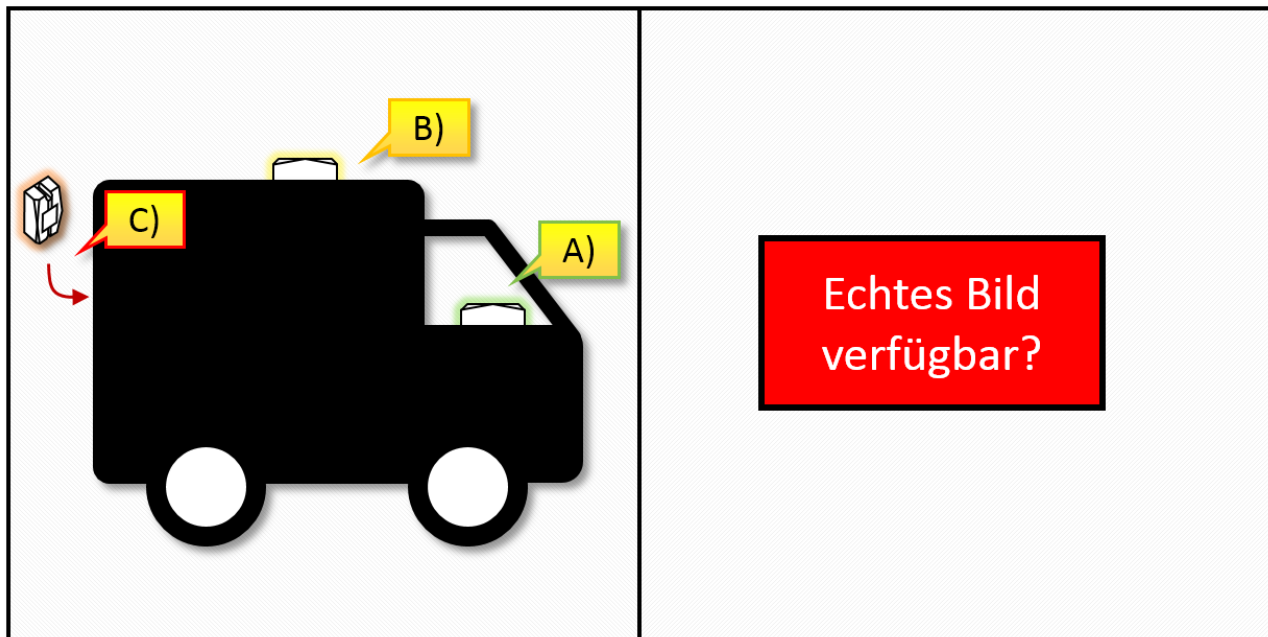

The attachment of the device to vehicles participating in road traffic should only take place indoors or should be protected in such a way that no other road user can be affected if the device falls off the vehicle.

- A) **Inside, behind the windscreen** (no risk for other road users)
- B) Outside, on top of the vehicle (risk to other road users if the device falls off)
- C) Inside the cargo space of the vehicle is not recommended (less GPS reception and weak Sigfox transmissions)



When the device is installed outside the vehicle, it must be ensured that it cannot fall off and thus affect other road users.

3.4 Account and Device Registration to h2n Track-it®

h2n Track-it® allows any new user to register and open an account without any limitation. After an automated account verification by E-Mail a new user can register his devices and group his devices as needed hierarchically and individually. The device selector allows to select and view individual devices or groups of devices as needed.

Devices can be registered, by using the ID and PAC of the device, by any user. The ID and PAC can only be used once due to security measures, so that the devices in the field can not be taken over by other users. For OEM's devices can also be pre-registered by h2n. The initial location setup can be used to give the device a proper location or specify latitude and longitude for devices without location sensors like door alarms or impact sensors. Tags and names can be set by the user to give a better overview and clear descriptions for devices.

Create a new Account

If you are not yet registered in the portal, proceed as follows:

1. Navigate to <https://app-track-it.h2n.io> and click on “Register” to create a new account.
2. Enter your Email and password. Click on “Register” to finish the registration:
 - A) Enter a valid Email address
 - B) Enter a password
 - C) Confirm your password

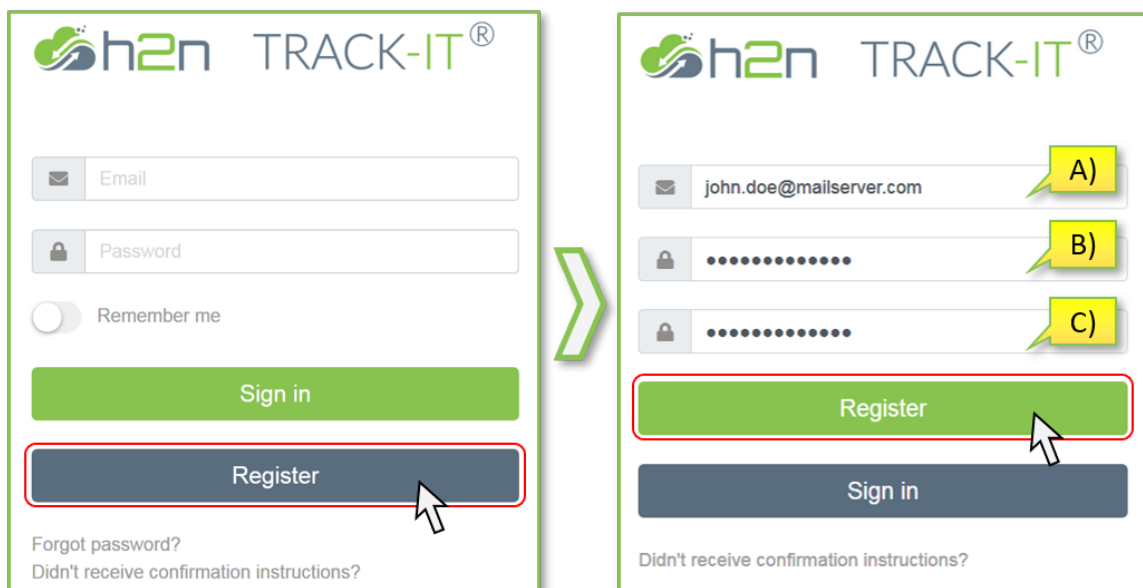

The image shows two screenshots of the h2n TRACK-IT® registration process. The left screenshot shows the registration form with the 'Register' button highlighted. The right screenshot shows the form filled out with an email address, password, and confirmation password, with the 'Register' button highlighted and a mouse cursor over it.

Left Screenshot: The h2n TRACK-IT® logo is at the top. Below it are three input fields: 'Email', 'Password', and 'Remember me' (with a toggle switch). There are two buttons: a green 'Sign in' button and a dark blue 'Register' button. The 'Register' button is highlighted with a red box and a mouse cursor. At the bottom, there are links for 'Forgot password?' and 'Didn't receive confirmation instructions?'.

Right Screenshot: The h2n TRACK-IT® logo is at the top. Below it are three input fields: 'Email' (containing 'john.doe@mailserver.com'), 'Password' (containing dots), and 'Confirm Password' (containing dots). Each input field has a yellow callout bubble labeled A), B), and C) respectively. There are two buttons: a green 'Register' button and a dark blue 'Sign in' button. The 'Register' button is highlighted with a red box and a mouse cursor. At the bottom, there is a link for 'Didn't receive confirmation instructions?'.

3. In a next step you will receive a confirmation Email. Please confirm your account by clicking on the link provided in the Email.
4. You successfully created a new account. You can now login to use the h2n Track-it® Cloud application.

Register a Device to your Account

To register a new Device to your account, proceed as follows:

1. login to the website <https://app-track-it.h2n.io>

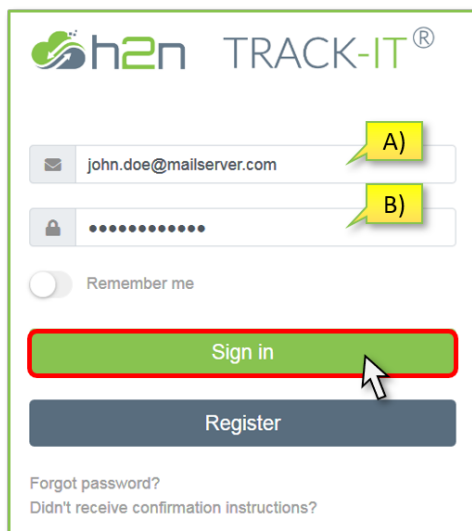

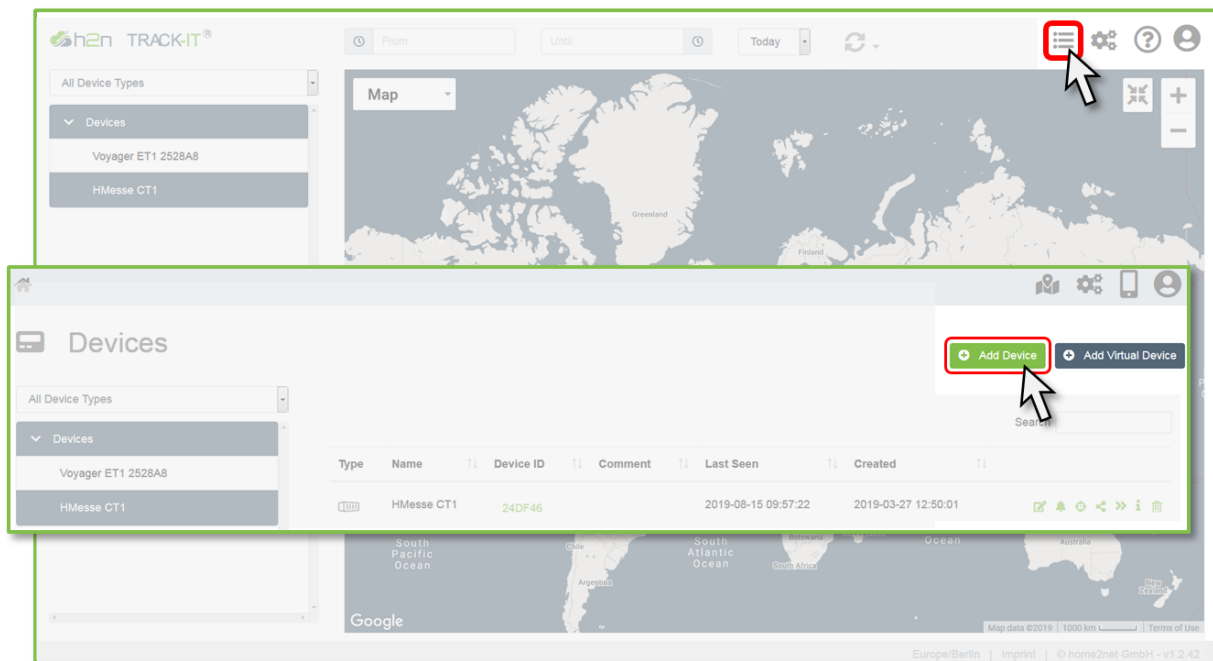

- A) Enter your Email address
- B) Enter your password

2. Enter the Device Management, Click on “Add Device”

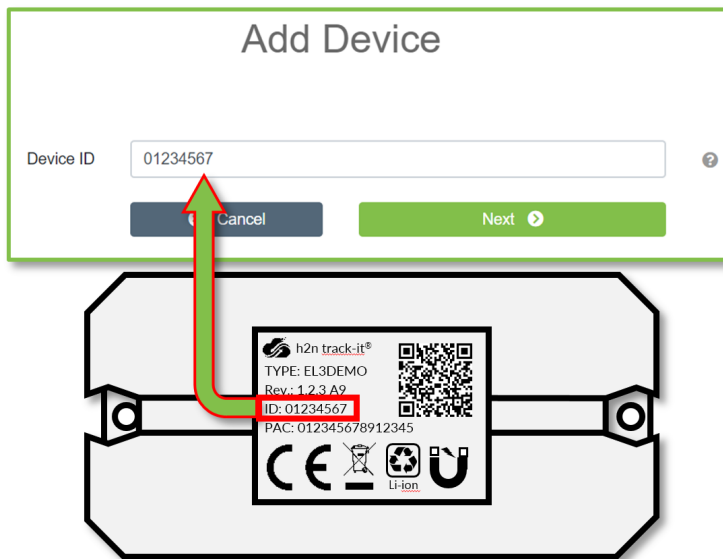

3. Add a Device: Enter the Device ID, which is printed on the label of the Device



 If you are not able to add the device, please validate your input. If still no registration is possible, click on the "Cannot register device" button. The support team will then be informed and will contact you.

4. Fill out the form and click on SAVE.

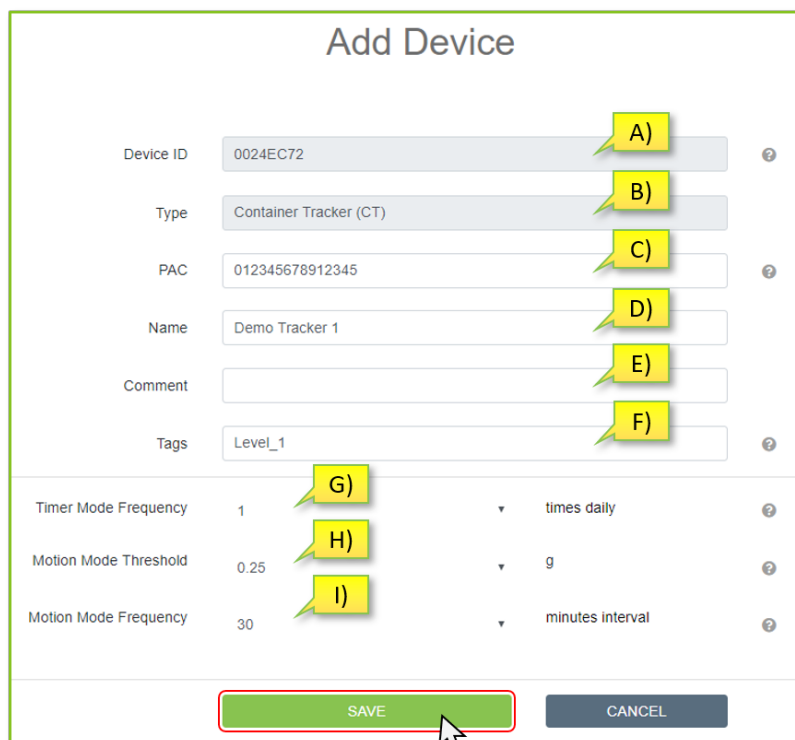

- A) Here, the Device ID is displayed. You are not able to change the ID in this window.
- B) The type of the Device is detected automatically, depending on the Device ID.
- C) Please enter the PAC. The PAC is printed on the device label as HEX value (0...F).
- D) Give the device a clear name.
- E) Enter a comment, if desired.
- F) Enter a Tag, if desired. Tags can be used to arrange devices into groups. Example:
Level_1,Level2,...
- G) The Timer Mode Frequency can be set individually: 1, 2, 3, 4, 6, 12 times / day
- H) Threshold level that triggers motion mode. If this value is exceeded, a movement is registered.



Please keep in mind, that an increased transmission frequency will lead to a higher power consumption. If not really necessary, select a low Timer Mode Frequency and / or Motion Mode Frequency.

5. The registration is finished. Now, the Device is waiting for Sigfox registration. This can take several minutes.

- A) As long as the registration has not been completed, "Waiting for registration" is displayed in the column "Name". When the registration is complete, the selected name appears here.

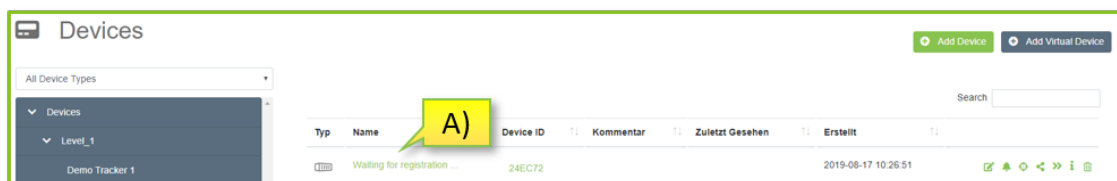



3.5 Maintenance

The ELOC3 Devices are maintenance free and need no service at all.

The user needs to make sure that the devices are mounted properly. The devices should not be covered by sheets of metal which would interfere with the functionality and connectivity of the device. Please do not place the device next to a magnet to avoid interference.

An empty battery is indicated in the h2n Track-it® cloud when the voltage drops below 2.4 volts.

4 Operation and use: h2n-track-it®

This chapter describes how to use the h2n-track-it® Cloud application. After the device has been installed and registered, various settings can be made via the web application and the location and sensor data can be read out.



For more detailed installation instructions, please refer to Chapter 3.

4.1 Main Screen

Devices can be tracked on scalable maps in street view or satellite view for the actual day or any user specified time range. To use the service, login to the web portal: <https://app-track-it.h2n.io>. The following Figure shows the main screen.

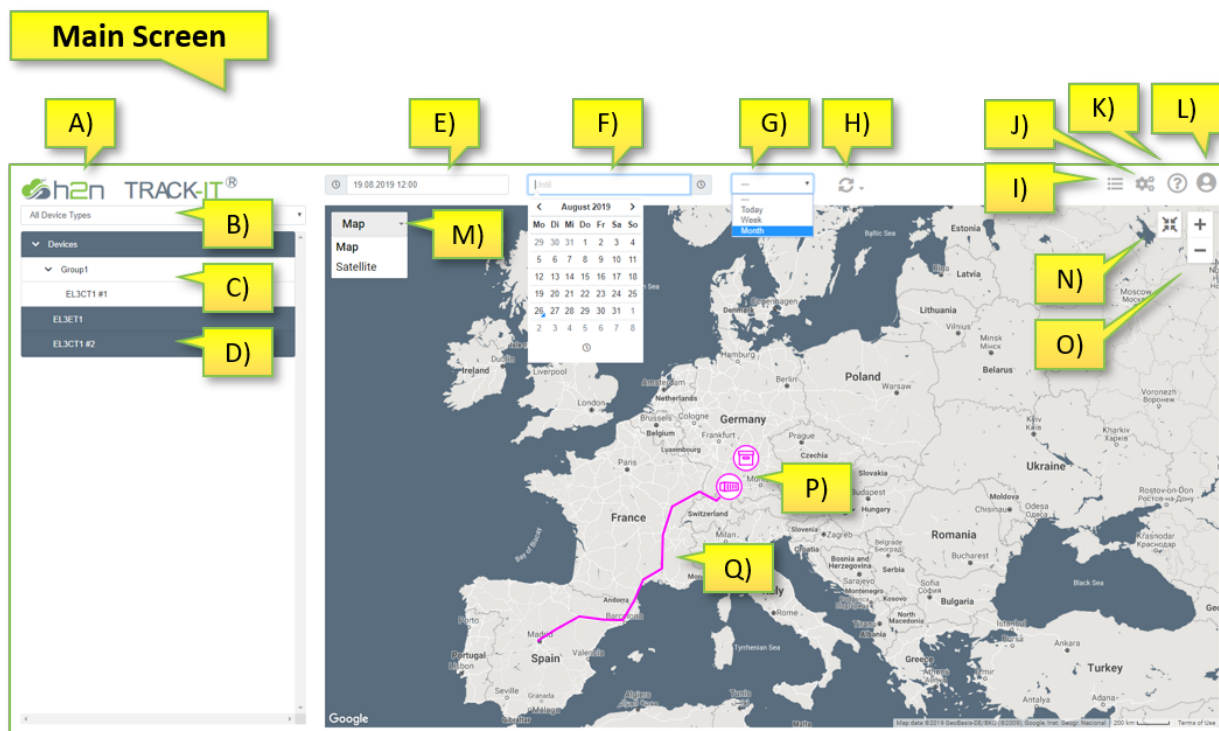

- A) Click here, to go back to the main screen.
- B) Select the device types which should be displayed on the map (Container Tracker, Vehicle Tracker, Equipment Tracker, ...).

- C) Click on the arrow to show your grouped devices. Click on the group to select all devices within this group.
- D) Select single devices to show them on the map.
- E) Specify here, from when you want to track the device's route.
- F) Enter the date and time until which you want to track the device's route.
- G) Fast selection, to the see the device's route from today, the last week or last month.
- H) Reload the Map.
- I) Enter the Device Management
- J) Enter the Settings.
- K) Enter the Frequently Asked Questions (FAQs).
- L) See your profile you are logged in with. Here, you can logout.
- M) Change the Map View.
- N) Click to recenter the map.
- O) Zoom in (+) / out (-).
- P) Icons of the Devices.
- Q) Route of the Device within the defined time range.





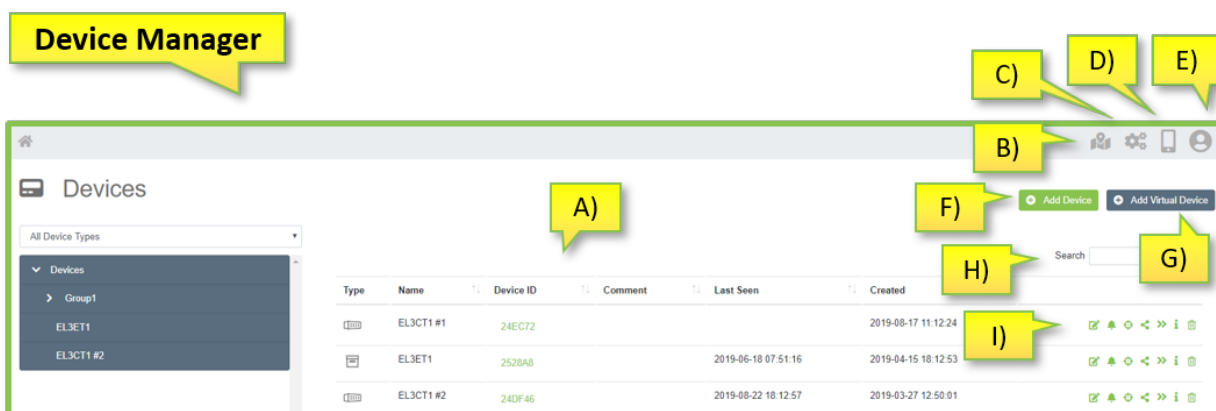

4.2 Device Manager

In the Device Manager new devices can be added and all registered devices are listed with the corresponding details. In addition, the defined options for each device can be viewed and adjusted accordingly.



A) All selected devices are listed here.

- B) Select to go back to the map.
- C) Enter the Settings.
- D) Pair with App for Device registration.
- E) See your profile you are logged in with. Here, you can logout.
- F) Add a new Device.
- G) Add a Virtual Device.
- H) Enter an ID here to filter the Devices listed in A).
- I) Here, the settings for each Device can be setup.

	Enter the Device Settings: Name, Comment, Tag, Timer Mode Frequency, Sensor Settings.
	Enter the Notification Settings.
	Edit / add geo-fences.
	Share or transfer the Device. You are able to generate a web link to share the data of the Device for a specified time range or share with other h2n-track-it [®] registered users.
	Edit and add Callback Forwards.
	Show Device information: Sigfox Device Details, Messages.
	Delete the Device.

4.3 Geo-fences

The user can define geo-fences for each device to receive notifications when a device exits or enters a defined area.

The screenshot shows the 'Add Geofence' form with the following fields and callouts:

- A)** Points to the 'Type' dropdown menu, currently set to 'Enter'.
- B)** Points to the 'Name' text input field, containing 'Geofence #1'.
- C)** Points to the 'Active on' section, where Monday through Friday are selected with radio buttons.
- D)** Points to the 'From' time input field, set to '13:00'.
- E)** Points to the 'Until' time input field, set to '21:00'.
- F)** Points to the 'Latitude' and 'Longitude' input fields, which contain the coordinates 48.1349408129714 and 11.5803222476527 respectively. A location pin icon is visible to the right of these fields.
- G)** Points to the 'Radius in meter' input field, set to '2000'.

At the bottom of the form are 'SAVE' and 'CANCEL' buttons. A 'TEST' button is located next to the 'Email Address, SMS' field.

- A) Define whether a notification should be sent when the device enters or exits (or both) a defined area.
- B) Give the geo-fence a clear name.
- C) Select the weekdays, when the geo-fence shall be active.
- D) Select the time, when the geo-fence shall be active.
- E) Enter your Email address. Click on „TEST“ to receive a test message.
- F) Define the geo-fence. It is possible to define the Latitude and Longitude directly or to select a location on the map (click the button on the right)
- G) Enter the desired radius of the geo-fence in meter

After the geo-fence has been defined, it can be displayed in the map. Double click on the geo-fence to edit or delete it.



4.4 Sensor data display

A graphical user interface shows the status and historical data by a simple click on any device icon on the map.

