

## OMNI-704



## User Guide

### South Africa

Unit 4, N1 Industrial Park  
Landmarks Ave  
Samrand, 0157  
South Africa  
Tel: +27 12 657 0050  
info@poynting.tech

### Europe

Kronstadler Straße 4,  
81677 München  
Germany  
Tel: +49 89 2080 265 38  
Mob.: +49 176 529 733 50  
sales-europe@poynting.tech



# Index

---

1.	Packing Check List	4
2.	Introduction	7
		<a href="http://www.ime.de">www.ime.de</a>
3.	Antenna Mounting Precautions	9
4.	Cable Routing	9
5.	Safety	10

# 1. Packing Check List

---

Item	Description	Quantity
1. 	A-OMNI-0704 Antenna Only	1  <small>www.ime.de</small>
2.	Wall Knock-in Screws	2
3.	Pipe Clamp	1
4.	Adhesive Disc	1
5.	L-Bracket	1
6.	M4 stainless steel machine screw and washer	4

# Appearance of Components

## Antenna Unit

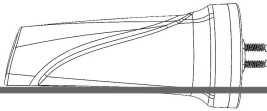

www.ime.de

## Wall Knock-in Screw



## Pipe Clamp

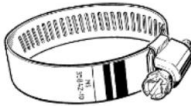

## Adhesive Disc

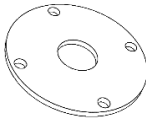

## L-Bracket



## M4 machine screws and M4 flat washers

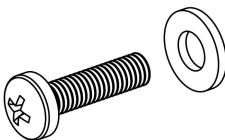

**Tools which may be required:**

**6mm Masonry drill bit**



[www.ime.de](http://www.ime.de)



**Impact drilling machine**

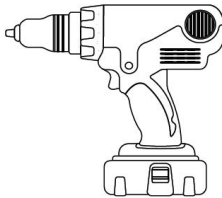

**Screw driver-Cross slot/Philips**

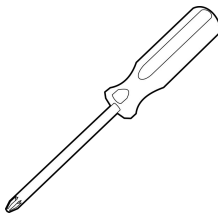

**Hammer**

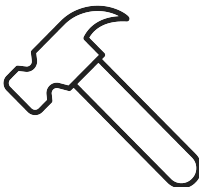

## 2. Introduction

This User Guide provide information on the installation instructions of the Omni-directional antenna (A-OMNI-0704).

For both pole and wall mount options, attach the L-bracket to the antenna first using the provided M4 screws and washers.

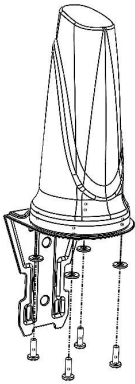

### Antenna Configuration 1

Pole mount with L-Bracket and pipe clamp  
Exploded View

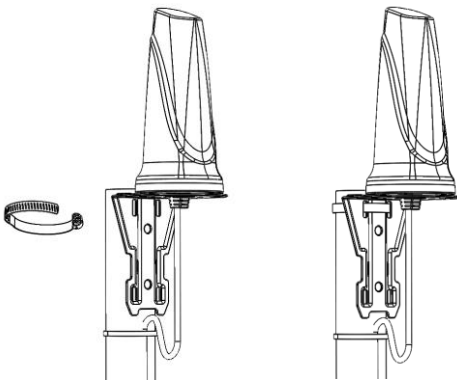

## Antenna Configuration 2

Wall mount with L-Bracket and knock-in screws

Use the L-bracket as a template to drill holes



www.ime.de

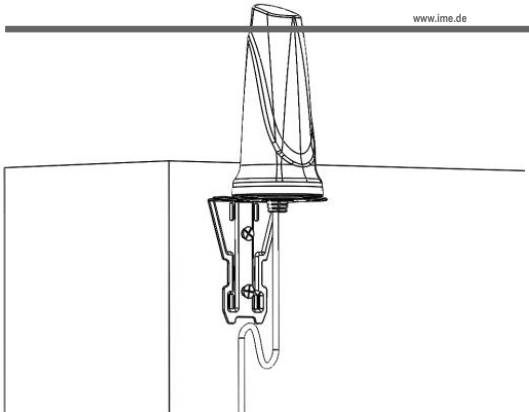

## Antenna Configuration 3

Surface mount with adhesive disc

Use adhesive disc as template for drilling a cable hole

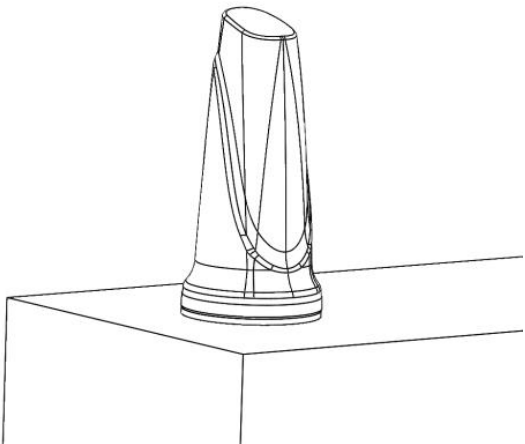



### 3. Antenna Mounting Precautions

---

- Place the antenna at the highest point and ensure that there aren't any surrounding obstructions to the antenna.
-  In order to avoid communication interference, ensure that the antenna is placed at least 0.5m away from other antennas and metal objects. www.ime.de
- Avoid installing the antenna near a chimney, as the smoke and soot emitted by the chimney can obstruct the signal level achieved by the antenna.
- Install the antenna away from heat sources and flammable gases.

### 4. Cable Routing

---

- Survey the planned cable route and look for any blocked passages. Consider alternate routes to find the best available path. Always keep the cables as short as possible to make sure that minimum cable losses are achieved.
- Note: Take advantage of any existing cable channels. e.g wiring conduits to route the cables.
- Avoid running cables through components or sharp apertures that may cause excessive chafing. Doing so may erode the jacket and break signal continuity. Also, avoid kinking, pinching, or twisting a cable during a run.
- Use cable ties to secure the antenna cables.

## **When handling the antenna cables, it is essential you follow these basic rules:**

- Never pull on the cable connectors; pull only on the cable.
- Tighten the connectors and ensure that the cables don't rattle loose.



## 5. Safety

www.ime.de

- If you are installing an antenna for the first time or unsure about how to install your antenna, obtain the help of a professional installer.
- Carefully survey the installation site before installation to locate secure handholds, dangerous conditions (such as power lines and weak roofs) and the safest and most convenient placement for ladders if necessary.
- The antenna may not be used as a climbing or pulling device.
- Considerations must be taken when mounting the antenna that people do not hang or pull on it.
- When installing your antenna, remember:
  1. Do not install near power lines as they can electrocute you.
  2. Do not install on a wet or windy day or when there is lightning or thunder in the area.
  3. Wear shoes with rubber soles and heels, protective clothing (long sleeve shirt or jacket) and rubber gloves.
  4. Avoid installation while under the influence of drugs, alcohol or medication.

5. Make sure that any loose-fitting jewellery or clothing is secured and tie back long hair as they can get caught in moving parts during installation.

6. If the antenna assembly starts to fall, get version away from it and let it fall to avoid harming yourself.



www.ime.de

- When drilling, remember;
  1. Use safety goggles when drilling the holes.
  2. Avoid using bits that are dull, bent or damaged.
  3. Be aware of where your fingers are in relation to the drill bit when using the drilling machine.
  4. To stop the drilling machine, let the drill chuck come to a complete stop on its own. Do not grasp the chuck in an attempt to stop the drill bit.
  5. Avoid awkward hand positions where a sudden slip could cause a hand to move into the drill bit or cutting tool.