













ANTENNAS | OMNI-214 SERIES

OMNI-DIRECTIONAL, 4X4 MIMO LTE/5G ANTENNA

617 – 3800 MHz; 3.5 dBi



 617 – 960 MHz 1427 – 1517 MHz 1710 – 2700 MHz 3400 – 3800 MHz	 3.5 dBi	 Omni-Directional	 Increase x Mb/s	 4G LTE	 5G
 CBRS Band	 4x4 MIMO	 617 – 698 MHz -40°C to 80°C	 -40°C to 80°C	 IP 65	 Salt Spray Protection

- Ultra-wideband, Omni-directional antenna
- 4x4 MIMO capability for improved performance
- Covers contemporary LTE/5G bands
- Robust, dust and water-resistant enclosure design (IP 65)

APPLICATION AREAS

-  Urban
-  Rural/Farm
-  Industrial

Product Overview

The OMNI-214 is an ultra-wideband antenna, which covers all contemporary LTE/5G frequency bands with excellent balanced gain across all frequencies from 617 to 3800 MHz. The antenna offers 4x4 MIMO capability from its vertically separated radiating elements, all in the same single radome. The antenna design allows for superior pattern control over the entire frequency range, making the OMNI-214 a true omni-directional 4x4 MIMO antenna, suitable for urban or commercial applications. The OMNI-214 guarantees signal reception almost everywhere and is usable in all part of the world. The ultra-wideband performance makes the antenna future proof, as it covers LTE Band 71 (617 to 698 MHz) as well as the CBRS bands from 3400 to 3800 MHz for inland use. The antenna comes with an IP65 protection rating against dust and water ingress, making it ideal for urban and commercial deployments.

Features

- 4x4 MIMO capable for improved performance
- Wideband Omni-directional antenna (617 to 3800 MHz)
- Includes Band 71 (617 to 698 MHz) and 3.5 GHz 5G band
- Robust and weather resistant enclosure with IP 65 rating
- UV and salt-water resistant enclosure

Application Areas

- Enhanced LTE/4G and 5G reception
- Increase system transmission reliability
- High-end industrial grade router applications
- Industrial and commercial LTE/5G deployment
- Agricultural and farming LTE/5G data distribution



Frequency Bands

The OMNI-214 is an omni-directional antenna that works from | 617 – 960 MHz | 1427 – 1517 MHz | 1710 – 2700 MHz | and | 3400 – 3800 MHz |

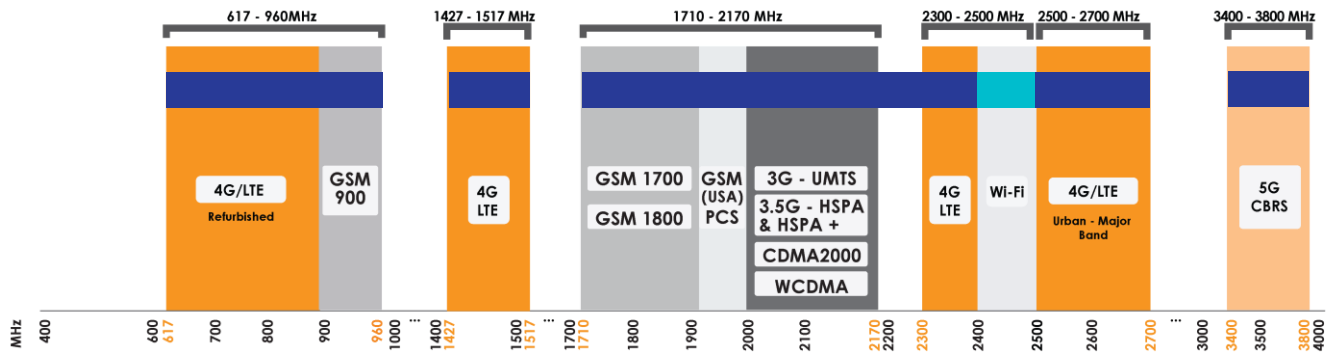

 Indicates the LTE bands on which OMNI-214 works

 Indicates the WI-FI bands on which OMNI-214 works

Antenna Overview

	
Ports	4
SISO / MIMO	MIMO
Frequency Bands	617 - 3800 MHz
Polarisation	Linear (Vertical)
Peak Gain	3.5 dBi
Coax Cable Type	HDF 195
Coax Cable Length	2m
Connector Type	SMA (M)

**The coax cable & connector are factory mounted to the antenna*

Electrical Specifications

Frequency Bands:	617 – 960 MHz 1427 – 1517 MHz 1710 – 2700 MHz 3400 – 3800 MHz
Gain (Max):	-1.8 dBi @ 617 - 960 MHz 1 dBi @ 1427 - 1517 MHz 3.5 dBi @ 1710 – 2700 MHz 1.8 dBi @ 3400 - 3800 MHz
Gain (Mean):	-2 dBi @ 617 - 960 MHz -1 dBi @ 1427 - 1517 MHz 0 dBi @ 1710 – 2700 MHz 0 dBi @ 3400 - 3800 MHz
VSWR:	<2:1 across 90% of the bands
Feed Power Handling:	10 W
Input Impedance:	50 Ohm (nominal)
Polarisation:	Linear Vertical
Coax cable loss:	0.385 dB/m @ 900 MHz 0.507 dB/m @ 1500 MHz 0.565 dB/m @ 1800 MHz 0.666 dB/m @ 2400 MHz 0.788 dB/m @ 3000 MHz
DC short:	Yes

Product Box Contents

Antenna:	A-OMNI-0214-V1-01
Mounting Bracket:	L-bracket (Ø30-50mm pole)

Ordering Information

Commercial name:	OMNI-214
Order product code:	A-OMNI-0214-V1-01
EAN number:	6009710923665

Mechanical Specifications

Product Dimensions (L x W):	646 mm x Ø71 mm (Excluding bracket)
Packaged Dimensions:	690 mm x 95 mm x 96 mm
Weight:	0.795kg
Packaged Weight:	1.585kg
Radome Material:	UV Stable ASA
Radome Colour:	Brilliant White Pantone P 179-1C
Mounting Type:	Wall and Pole mount options

Environmental Specifications, Certification & Approvals

Wind Survival:	≤160 km/h
Temperature Range (Operating):	-40°C to +80°C
Environmental Conditions:	Outdoor/Indoor
Water Ingress Protection Ratio/Standard:	IP 65
Salt Spray:	MIL-STD 810G/ASTM B117
Operating Relative Humidity:	Up to 98%
Storage Humidity:	5% to 95% - non-condensing
Storage Temperature:	-40°C to +80°C
Enclosure Flammability Rating:	UL 94-HB
Impact Resistance:	IK 08
Product Safety & Environmental:	Complies with CE and RoHS standards

Antenna Performance Plots

VSWR: Cell 1

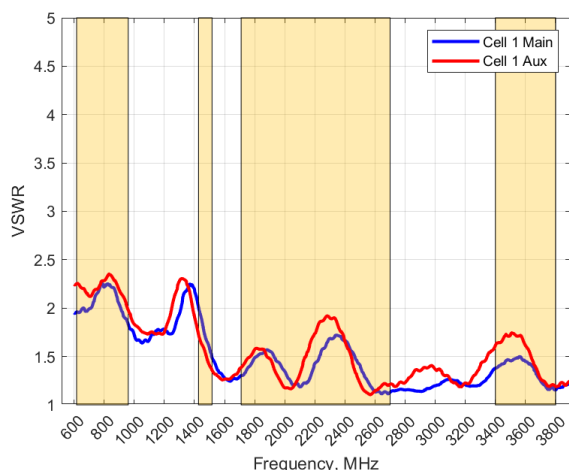

Voltage Standing Wave Ratio (VSWR)*

VSWR is a measure of how efficiently radio-frequency power is transmitted from a power source, through a transmission line, into a load. In an ideal system, 100% of the energy is transmitted which corresponds to a VSWR of 1:1.

The OMNI-214 delivers superior performance across all bands with a VSWR of 2:1 or better across 90% of the bands.

**VSWR measured with a 2m low loss cable*

VSWR: Cell 2

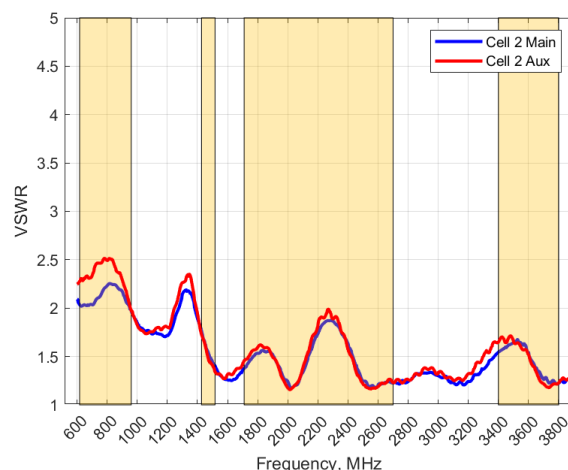

Voltage Standing Wave Ratio (VSWR)*

VSWR is a measure of how efficiently radio-frequency power is transmitted from a power source, through a transmission line, into a load. In an ideal system, 100% of the energy is transmitted which corresponds to a VSWR of 1:1.

The OMNI-214 delivers superior performance across all bands with a VSWR of 2:1 or better across 90% of the bands.

**VSWR measured with a 2m low loss cable*

GAIN (EXCLUDING CABLE LOSS)

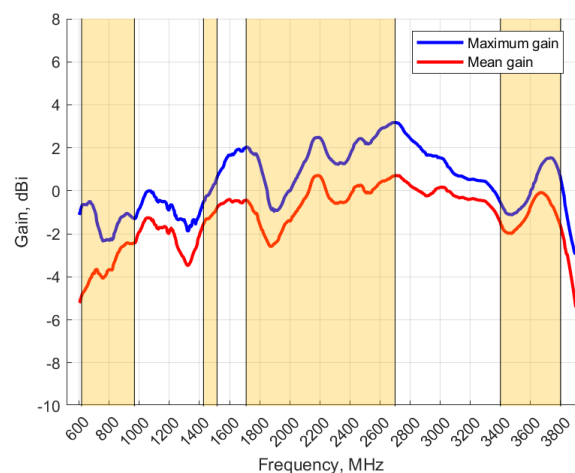

Gain* in dBi

3.5 dBi is the peak gain across all bands from 617 – 3800 MHz

Gain @ 617 – 960 MHz (Max; Mean):	-1.8 dBi; -2 dBi
Gain @ 1427 – 1517 MHz (Max; Mean):	1 dBi; -1 dBi
Gain @ 1710 – 2700 MHz (Max; Mean):	3.5 dBi; 0 dBi
Gain @ 3400 – 3800 MHz (Max; Mean):	1.8 dBi; 0 dBi

**Antenna gain measured with polarisation aligned standard antenna*

Isolation

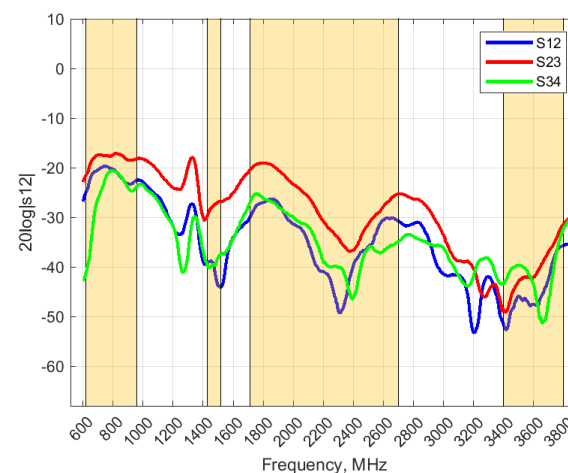

Isolation

Isolation is a measure of the amount of energy leaked from one port to another. In an ideal case no energy should leak from port one to port another.

Technical Drawings

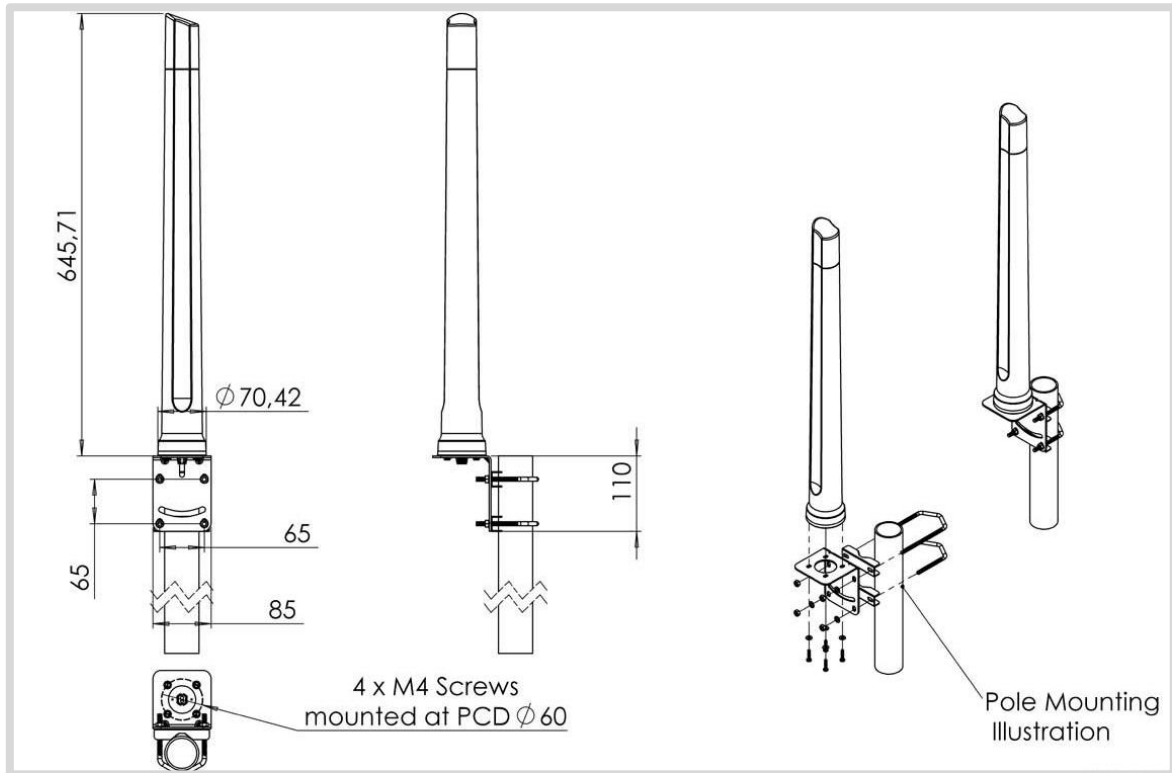

Radiation Patterns

Azimuth: 617 - 960 MHz

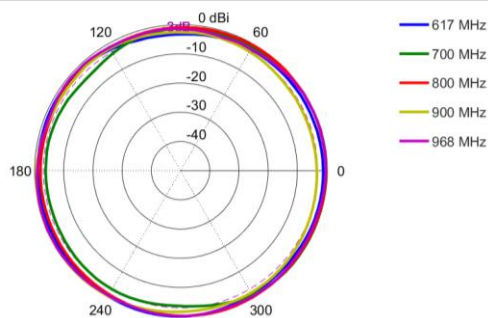

Azimuth: 1427 - 1517 MHz

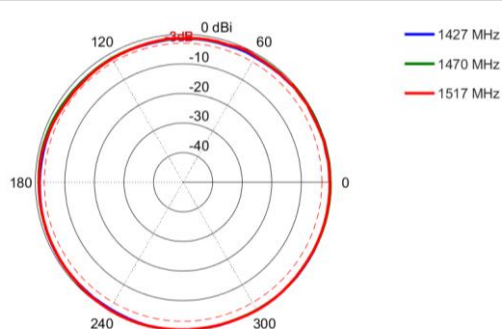

Azimuth: 1710 - 2170 MHz

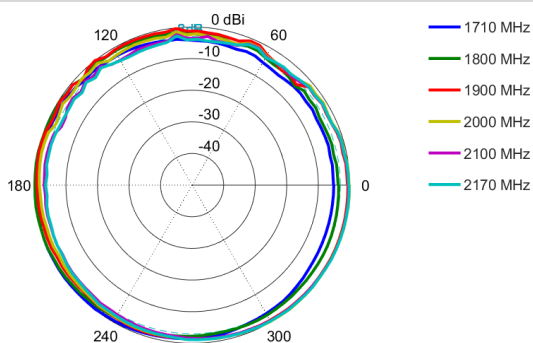

Azimuth: 2300 - 2700 MHz

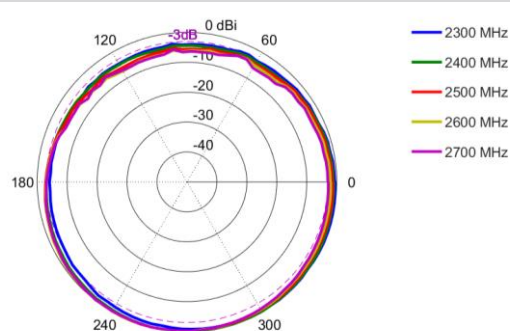

Azimuth: 3400 - 3800 MHz

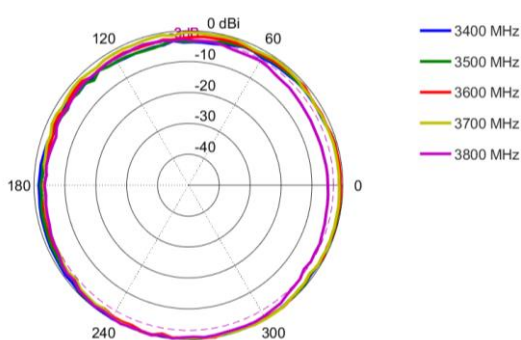

Elevation: 617 - 960 MHz

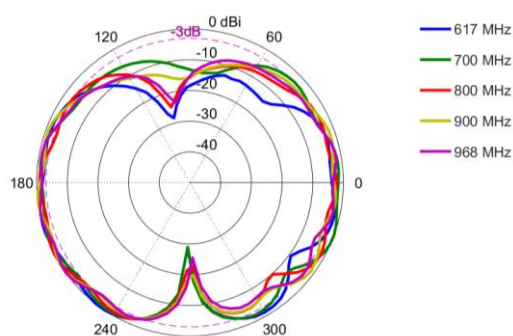

Elevation: 1427 - 1517 MHz

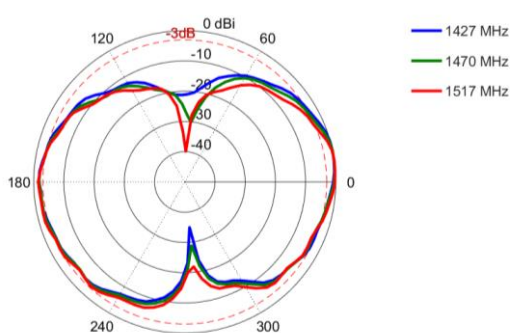

Elevation: 1710 - 2170 MHz

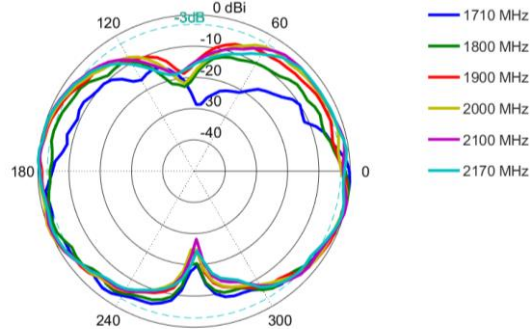

Elevation: 2300 - 2700 MHz

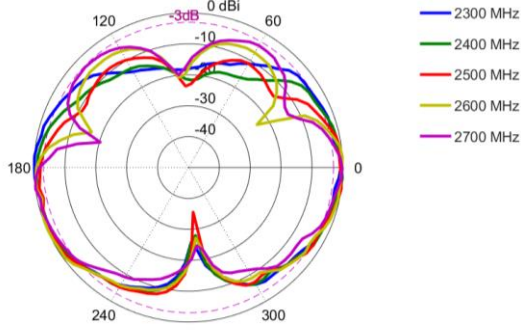

Elevation: 3400 - 3800 MHz

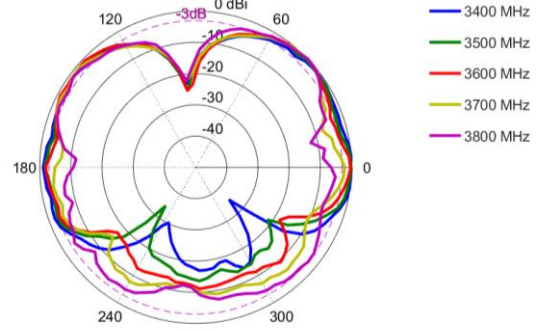

Mounting Options

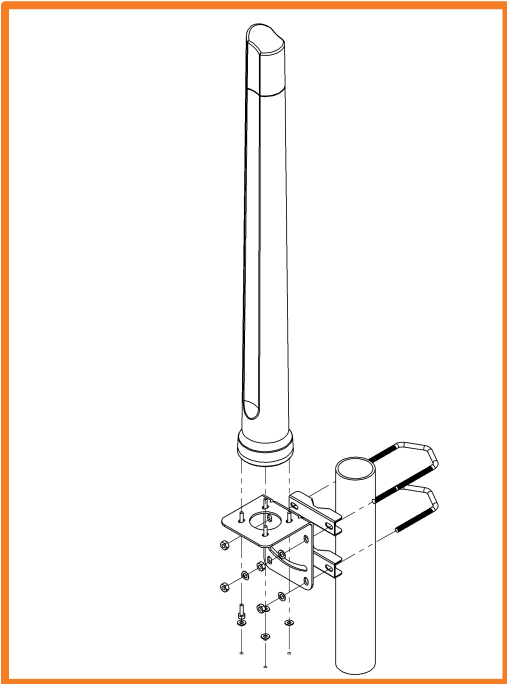

Pole Mount

Wall/Pole mount bracket included

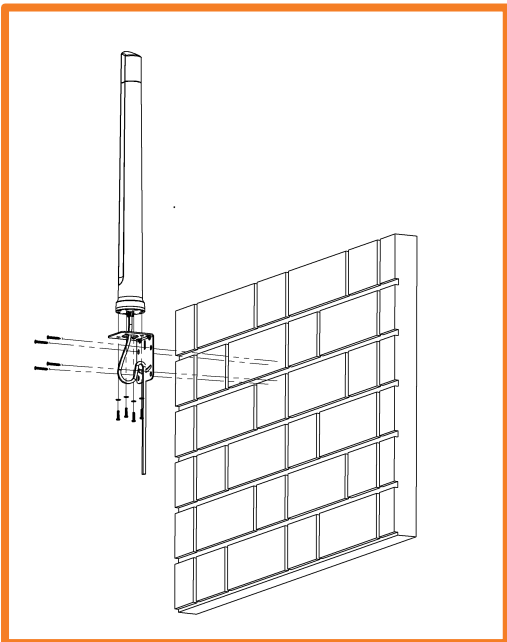

Wall Mount

Wall/Pole mount bracket included

Additional Accessories

Extension Cables: Up to 15m HDF 195
Various connectors available
Installation poles and brackets available

See accessories technical specifications on www.poynting.tech

CONTACT POYNTING

Poynting Antennas (Pty) Ltd - Head Office

Unit 4, N1 Industrial Park,
Landmarks Avenue,
Samrand, 0157, South Africa

Phone: +27 (0) 12 657 0050

E-mail: info@poynting.tech

International Email: sales-global@poynting.tech

Poynting Europe

Regus Business Center Neue Messe Riem
Kronstadter Straße 4
81677 München
Germany

Phone: +49 89 7453 9002

E-mail: sales-europe@poynting.tech

Poynting USA

1804 Owen Court, Suite 104,
Mansfield,
TX 76063
USA

Phone: +1 817 533-8130

E-mail: sales-us@poynting.tech