

# POYNTING

BEYOND A CONNECTED LIFE

---

## EPOYNT-4



[www.ime.de](http://www.ime.de)



## User Guide

Revision 2.0



# Index

---

1.	Packing Check List	4
2.	Introduction	8
		<a href="http://www.ime.de">www.ime.de</a>
3.	Setting up the CPE	8
4.	CPE Mounting Configurations	14
5.	CPE Mounting Precautions	19
6.	Cable Routing	20
7.	Safety	21
8.	Basic Troubleshooting	23

# 1. Packing Check List

Item	Description	Quantity
1. 	EPOYNT-4 CPE Only	1 <small>www.ime.de</small>
2.	Wall Knock-in Screws	4
3.	3mm Allen Key	1
4.	5mm Allen Key	1
5.	Pipe Clamp	2
6.	Surface Mount Gasket	1
7.	M6 x 90mm Stainless Steel U-Bolts	2
8.	PCB Mounting Screws	4
9.	Cable Ties	4
10.	M6 Nyloc and Standard Stainless Steel Nuts	4
11.	M6 Stainless Steel Flat Washers	4

# Appearance of components

## EPoynt-4 CPE



www.ime.de

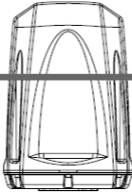

## Wall Knock-in Screw



## Allen Key



## Pipe Clamp

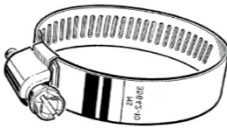

## Surface Mount Gasket

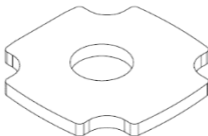

## PCB Mounting Screws

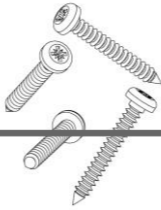

[www.ime.de](http://www.ime.de)

## U-Bolt



## Cable Tie

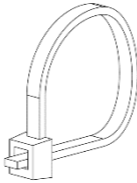

## M6 Nut and Washer

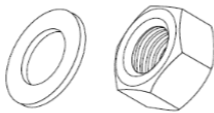

## Tools Required

---

### 6mm Masonry Drill Bit



[www.ime.de](http://www.ime.de)

### Impact Drilling Machine

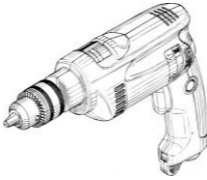

### Hammer



### Safety Goggles



### Screwdriver – Cross Slot/Philips

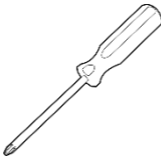

## 2. Introduction

This User Guide provide information on the installation instructions of the EPoynt-4 CPE.



www.ime.de

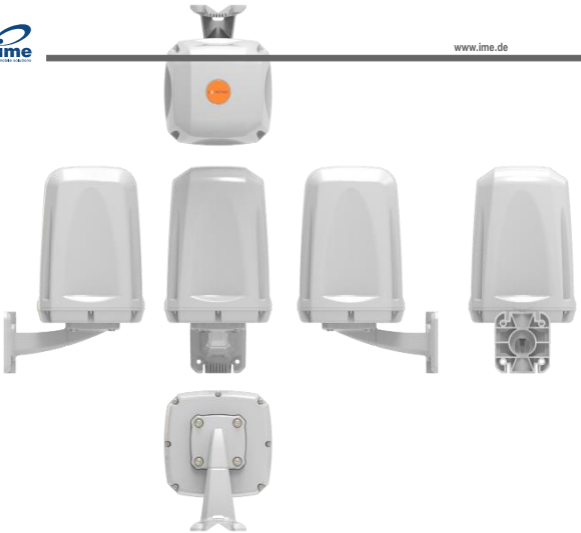

## 3. Setting up the CPE

### Step 1 Install your router into the CPE

- Carefully unscrew the bracket cap screws using the provided 5mm allen key.





- To access the router mounting plate, carefully unscrew the cap screws at the bottom of the CPE using the provided 3mm allen key.



www.ime.de



- Remove the mounting plate from the CPE base by carefully unscrewing it using a Philips screwdriver.



- Locate your router mounting holes and align the holes with those of the mounting plate. Secure the router onto the mounting plate using the provided self-tapping screws and/or cable ties.

**Note:** Your router dimensions should not exceed 140mm x 120mm x 50mm.

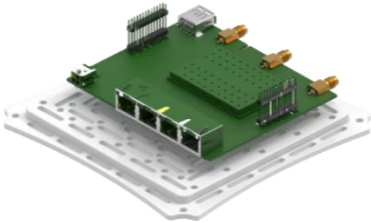
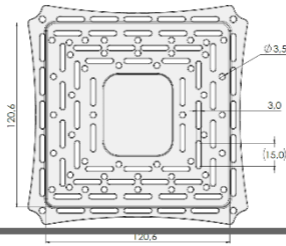

- Connect the CPE's antenna cables to the respective connectors on the router (LTE and/or Wi-Fi) using a suitable fly lead (sold separately). Unused antenna cables should be neatly wound and attached to the antenna plate appropriately.



- Route an Ethernet cable through the bracket and into the CPE's base.

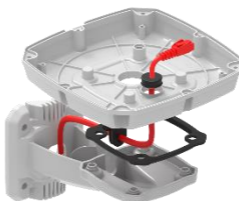

**Note:** If you are using a power supply to power your router, route your power cable through the bracket and into the central hole in the middle of the CPE base.

- Connect the Ethernet cable from the CPE's base to the router port labelled "PoE" or to any other router Ethernet port in case you will be using a power supply to power your router.



www.ime.de



- Carefully insert a SIM card into the router's SIM slot.

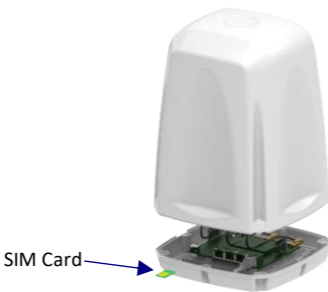

- Connect the earthing cable to one of the mounting points where the router is fastened to the mounting plate.
- Carefully screw the mounting plate with the already installed router back to the CPE base.



- Carefully place the CPE cover to close the CPE and screw the cap screws at the bottom of the base firmly. Do not over-tighten the screws, as this could strip the plastics.



- Carefully screw the bracket back to the CPE using the provided 5mm allen screw.



## Step 2 Power your CPE

### Method 1: Using a PoE Adapter

- Connect the other end of the Ethernet cable protruding from the CPE's bracket to the port labelled "PoE" on the PoE adapter.



www.ime.de

- Connect another network cable to the port labelled "LAN" on the PoE adapter and connect the other end of the cable to a computer or to a WAN/LAN port of an access point or switch.
- Plug the PoE adapter into an electrical socket and check to see if the power light on the PoE adapter is ON.

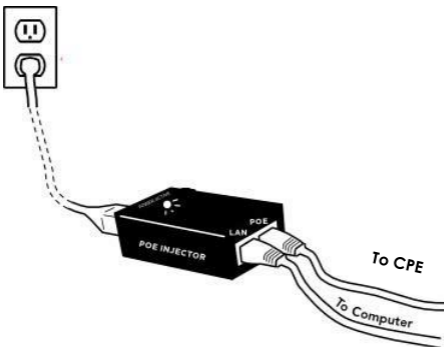

### Method 2: Using a Power Supply

- Extend your router's power supply cable using 0.70/0.75mm cable and route it along with your Ethernet cable through the bracket.

## 4. CPE Mounting Configurations

### Note:

Ensure that all RF/electrical connections made outdoors are adequately waterproofed. Waterproof connector boots are recommended.



www.ime.de

### Antenna Configuration 1

Wall mount with wall knock-in screws.

- Select a suitable place for mounting the CPE.
- Use a 6mm masonry drill bit to drill four holes into the wall.
- Insert the four knock-in screws through the bracket and into the drilled holes and screw the CPE firmly into place.

Exploded View

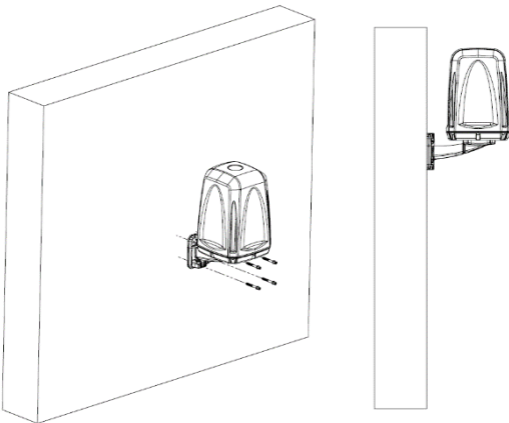

## Antenna Configuration 2

Pole mount with supplied U-bolts or pipe clamps.

- Select a suitable place for mounting the CPE.



- Lay the CPE out at the installation site and assemble the CPE on the ground.

[www.ime.de](http://www.ime.de)

- Place the pipe clamps or U-bolts through the bracket as shown below.
- Place the pipe clamps around the pole and tighten the screws on the pipe clamps until the bracket is secured to the pole. If you are using U-bolts, place the U-bolts around the pole and tighten the nuts until the bracket is secured to the pole.
- Mount the CPE so that there is at least 1 meter of clearance in all directions around it and unobstructed line of sight to a cell tower.
- Route the cable straight down the inside of the pole to avoid using extra equipment such as cable ties.

Exploded View

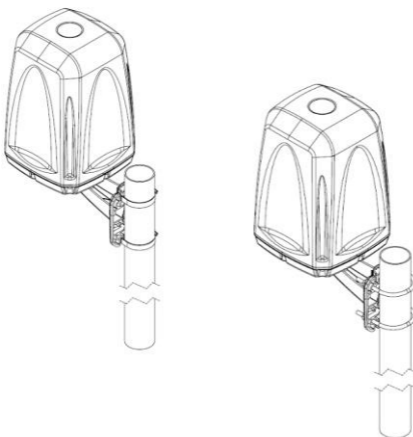

## Antenna Configuration 3

a) Surface mount with supplied surface mount gasket.

- Select a suitable surface for mounting the CPE.



www.ime.de

- Remove the CPE bracket by unscrewing the cap screws on the bracket using the provided 5mm allen key.
- Use a 6mm masonry drill bit to drill four holes into the surface. Drill another hole into your surface to route your Ethernet cable through. Use the below dimensions.

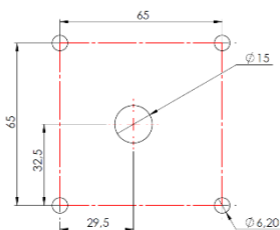

- Carefully place the gasket at the back of the CPE base and route the Ethernet cable through the gasket hole. If you are using a power supply to power your router, route the power cable along with the Ethernet cable through the gasket hole.

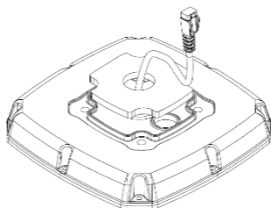



- Route the Ethernet cable from the gasket through the drilled central hole and then carefully screw the CPE onto the surface using appropriate M6 machine screws.



www.ime.de

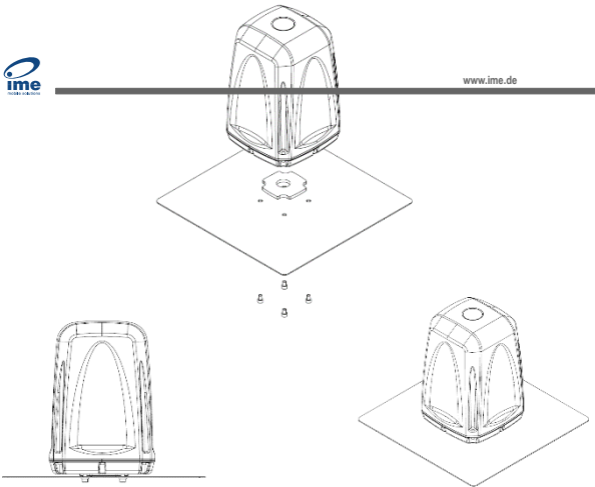

**b) Surface mount using optional bracket (BRKT-038) and MISC 103 Kit - NOT provided.**

- Select a suitable position for mounting the CPE.
- Remove the CPE bracket by unscrewing the cap screws on the bracket using the provided 5mm allen key.
- Carefully unscrew the cap screws at the CPE base using the provided 3mm allen key.
- Remove the router mounting plate from the CPE base by carefully unscrewing it using a Philips screwdriver.
- Thread the first locking nut onto the bracket (BRKT-038) followed by the seal.

- Place the CPE base followed by the second locking nut over BRKT-038 and tighten the CPE base firmly into place. Do not over-tighten the nuts, as this could crack the CPE base.



www.ime.de

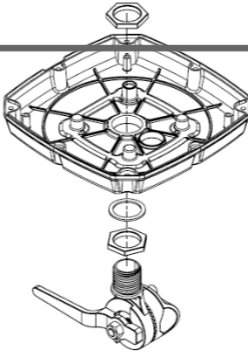

- Route the Ethernet cable through the CPE base.

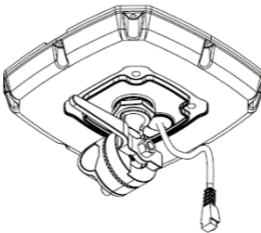

- Screw the router mounting plate with the already installed router back to the CPE base.
- Carefully place the CPE cover to close the CPE and screw the cap screws at the bottom of the base firmly. Do not over-tighten the screws, as this could strip the plastics.

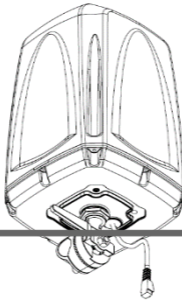

- Mount your CPE to a suitable horizontal rail.

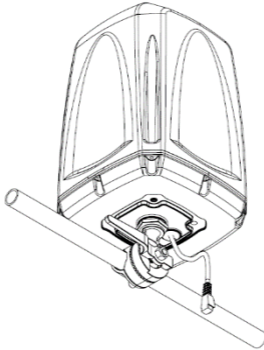

**Note:** The installer should ensure that the BRKT-38 cable entry hole is adequately waterproofed to maintain the CPE's IP rating. Additionally, should the thread of the marine mount bracket protrude too far into the CPE, make use of the locking nuts to raise the CPE base on it.

## 5. CPE Mounting Precautions

- Place the CPE at the highest point possible and ensure that there aren't any surrounding obstructions.
- In order to avoid communication interference, ensure that the CPE is placed at least 0.5m away from other antennas and metal objects.

- Avoid installing the antenna near a chimney, as the smoke and soot emitted by the chimney can obstruct the signal level achieved by the CPE's antenna.
- Install the CPE away from heat sources and flammable gases.



## 6. Cable Routing

- If the CPE is mounted on a pole, avoid wrapping the Ethernet cable around the pole. Route the cable straight down the inside of the pole to avoid using extra equipment such as cable ties.
- Never pull on the cable connectors; pull only on the cable ensuring the cable is not under tension.
- Cover connectors with insulation tape before threading them through a hole.

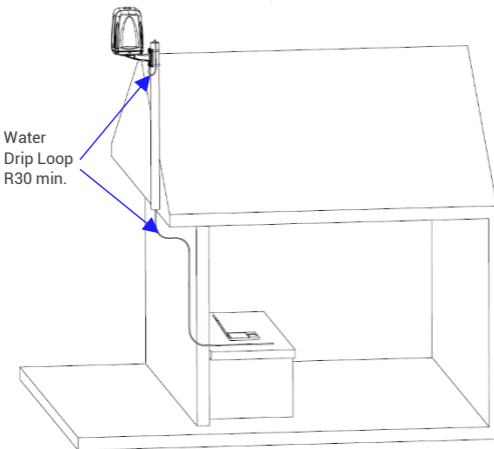

**Note:** The water drip loop is for preventing water from running down from the CPE along the cable into the house and possibly the PC or router.

## 7. Safety

---

- If you are installing the CPE for the first time or unsure about how to install your CPE, obtain the help of a professional installer.
 

www.ime.de
- Carefully survey the installation site before installation to locate secure handholds, dangerous conditions (such as powerlines and weak roofs) and the safest and most convenient placement for ladders if necessary.
- The CPE may not be used as a climbing or pulling device.
- Considerations must be taken when mounting the CPE that people do not hang or pull on it.
- When installing your CPE, remember:
  1. Do not install on a wet or windy day or when there is lightning or thunder in the area.
  2. Wear shoes with rubber soles and heels, protective clothing (long sleeve shirt or jacket) and rubber gloves.
  3. Avoid installation while under the influence of drugs, alcohol or medication.
  4. Make sure that any loose-fitting jewelry or clothing is secured and tie back long hair as they can get caught in moving parts during installation.
  5. If the CPE assembly starts to fall, get away from it and let it fall to avoid harming yourself.

- When drilling remember:

1. Use safety goggles when drilling the holes.
2. Avoid using bits that are dull, bent or damaged.
3. Be aware of where your fingers are in relation to the drill bit when using the drilling machine.
4. To stop the drilling machine, let the drill chuck come to a complete stop on its own. Do not grasp the chuck in an attempt to stop the drill bit.
5. Avoid awkward hand positions where a sudden slip could cause a hand to move into the drill bit or cutting tool.



[www.ime.de](http://www.ime.de)

**CAUTION:**

Antennas must be installed to provide a separation distance of at least 20cm from all persons so as to comply with SAR (Specific Absorption Rate) RF Exposure requirements.



European Waste Electronic Equipment Directive  
2002/96/EC

Please ensure that old waste, electricals  
and electronics are recycled.



Directive 2011/65/EU (RoHS 3)

This product is fully compliant with the RoHS 3  
directive.

## 8. Basic Troubleshooting

---

### 1. The CPE does not power ON.

- Make sure that the PoE adapter is fully plugged into the electrical socket and that the PoE power light is ON.



[www.ime.de](http://www.ime.de)

- If the PoE 's power light does not turn ON, check the electrical outlet with another electrical device that you know works or try a different outlet. If the power outlet works, then the PoE adapter may be damaged and needs to be replaced.
- If the PoE adapter has power but the CPE does not, the problem maybe the PoE network cable. Try a different network cable. Check that the network cable is securely plugged in between the PoE adapter and the CPE.
- If the CPE still does not power ON, unplug and re-plug the PoE adapter to restart the adapter and CPE. If this does not solve the issue, then there could be a problem with the router which may require replacement.

### 2. Problems logging into the router's web management page.

- Make sure that the CPE is ON.
- Verify that the CPE is correctly connected to the computer through a working network cable.
- Enable the computer to automatically obtain an IP address.



**South Africa**

Unit 4, N1 Industrial Park  
Landmarks Ave  
Samrand, 0157  
South Africa  
Tel: +27 12 657 0050  
info@poynting.tech

**USA**

1804 Owen Court,  
Suite 104, Mansfield,  
TX 76063  
Tel: +1 817 533-8130  
sales-us@poynting.tech

**Europe**

Kronstadler Straße 4,  
81677 München  
Germany  
Tel: +49 89 2080 265 38  
Mob.: +49 176 529 733 50  
sales-europe@poynting.tech