

# Quick Start GUIDE

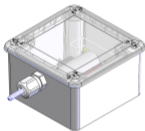

**Outdoor T°C**  
50-70-164

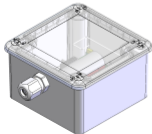

**PT 1000**  
50-70-126

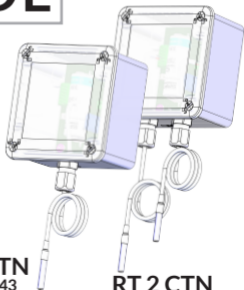

**RT 1 CTN**  
50-70-043  
**Remote THR**  
50-70-200

**RT 2 CTN**  
50-70-163

1

# Démarrer Start

Vue de côté  
Side view



Vue face  
Front view



LEDs



Provisionner l'appareil sur votre réseau LoRaWAN® avec les clés mises à dispositions sur la plateforme sécurisée.

*Provision the device on your LoRaWAN® network with the keys available on a secure platform.*

ON

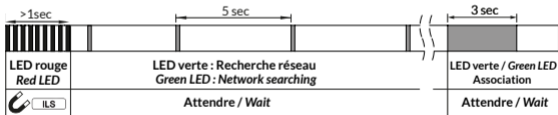

OFF

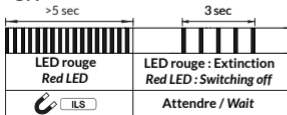

Vidéo / Video :  
ON - OFF



<https://www.watteco.fr/assistance/tutoriels-video/>

## 2

# Connectiques Connectors

PT 1000

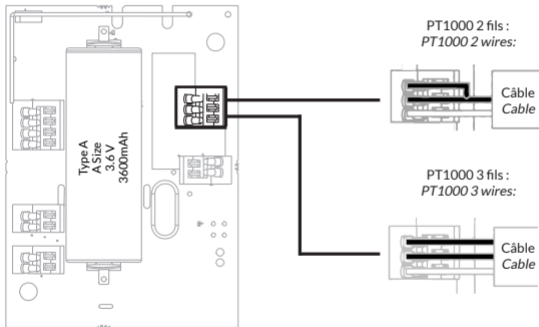

Le capteur PT1000 est livré sans sonde.  
Passez le câble dans le presse étoupe

*The PT1000 sensor is supplied without a probe.  
Pass the cable through the cable gland*

## 3

## Installation Setting up

Ouverture / Fermeture  
Opening / Closure

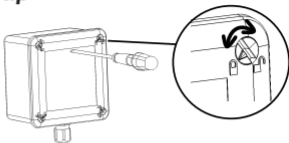

Montage mural  
Wall mounting



RailDIN

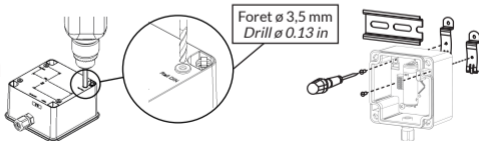

Attention, après mise en place du kit RailDIN, l'indice de protection du boîtier passe en IP50.  
Please note that after installation of the RailDIN kit, the protection rating of the housing will change to IP50.

## 3

## Installation Setting up

### Attention Warning



La sonde 2 est rouge : à installer sur tuyaux chaud  
*Probe 2 is red : to be installed on hot pipes*

La sonde 1 est bleue : à installer sur tuyaux retour  
*Probe 1 is blue : to be installed on return pipes*

Sonde 2  
*Probe 2*

Sonde 1  
*Probe 1*

### Prise de température sur tube

#### *Temperature measurement on tube*

Nettoyer la zone de contact  
*Clean the contact area*

Protection câble : Isolant thermique  
*Wire protection: Heat insulating*

Collier en acier  
*Heat resistant steel clamp*

Sonde  
*Probe*

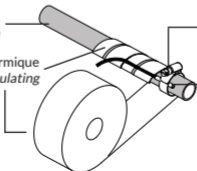

Serrer le collier sans écraser la sonde. Isoler la sonde avec le ruban.

*Tighten the clamp without crushing the probe. Insulate the probe with the tape.*

## 3

## Installation Setting up

### Prise de température avec un doigt de gant *Temperature measurement with the thermowell*

Nettoyer le logement intérieur du doigt de gant  
*Clean the inner housing of the thermowell*



Vis pointeau  
*Needle screw*

2

Pâte conductrice thermique  
*Thermally conductive paste*

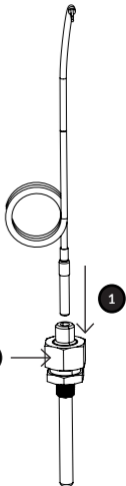

1

2

Fixer le câble sur un point d'appui avec l'aide de collier type Rilsan  
*Fix the cable on a support point with a Rilsan type clamp*

Dimensions : Ø 5mm / Longueur 24mm  
*Dimensions : Ø 5mm / Length 24mm*

4

## Propagation radioélectrique

### *Radio propagation*

Vérifier la couverture radio avec par exemple le Netw'O.

*Check the radio coverage with the Netw'O.*

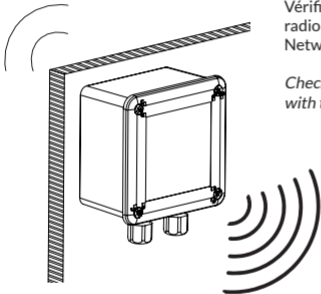
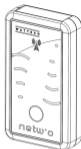

Pour que le capteur fonctionne correctement, le nombre d'obstacles doit être limité afin d'éviter une atténuation excessive des ondes radio.

*For the sensor communicates correctly, the number of obstacles should be limited to avoid excessive radio attenuation.*

## 5

# Caractéristiques

## Characteristics

Référence / Reference	50-70-163	50-70-126	50-70-164	50-70-043	50-70-200
Classe / Class	A	A	A	A	A
Niveau de puissance / Power Level	+14 dBm	+14 dBm	+14 dBm	+14 dBm	+14 dBm
Capacité maximum / Maximum capacity	2 sondes / 2 probes	1 sonde / 1 probe <small>(Non fournie / Not included)</small>	1 sonde / 1 probe	1 sonde / 1 probe	1 sonde / 1 probe
Mesures / Measures :					
Température / Temperature	✓	✓	✓	✓	✓
Humidité / Humidity					✓
Antenne / Antenna	Interne <i>Internal</i>	Interne <i>Internal</i>	Interne <i>Internal</i>	Interne <i>Internal</i>	Interne <i>Internal</i>
Matériaux du boîtier / Casing materials	ASA / PC	ASA / PC	ASA / PC	ASA / PC	ASA / PC
Indice de protection / IP rating	IP55	IP55	IP67	IP55	IP67





## SITE SUPPORT

<https://support.watteco.com/>



## CERTIFICATIONS

Watteco représenté par JC LE BLEIS, déclare que l'équipement radioélectrique du type 50-70-163 / 50-70-043 / 50-70-200/50-70-164 / 50-70-126 est conforme à la directive 2014/53/UE (RED). Le texte complet de la déclaration UE de conformité est disponible à l'adresse internet suivante: <https://www.watteco.fr/assistance/centre-de-telechargement/>

Watteco represented by JC LE BLEIS, declares that the radio equipment type 50-70-163 / 50-70-043 / 50-70-200/50-70-164 / 50-70-126 is in conformity with Directive 2014/53/EU (RED). The full text of the EU Declaration of Conformity is available at the following web address: <https://www.watteco.com/assistance/download-center/>



**WATTECO**

IoT device manufacturer

**Merci d'avoir choisi  
les produits WATTECO**

*Thanks for choosing  
WATTECO devices*