

Quick Start GUIDE

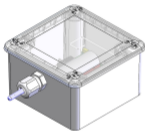

Outdoor T°C
50-70-164

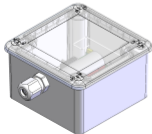

PT 1000
50-70-126

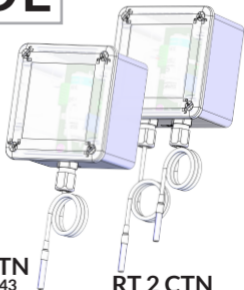

RT 1 CTN
50-70-043

Remote THR
50-70-200

RT 2 CTN
50-70-163

1

Démarrer Start

Vue de côté
Side view



Vue face
Front view



LEDs



Provisionner l'appareil sur votre réseau LoRaWAN® avec les clés mises à dispositions sur la plateforme sécurisée.

Provision the device on your LoRaWAN® network with the keys available on a secure platform.

ON

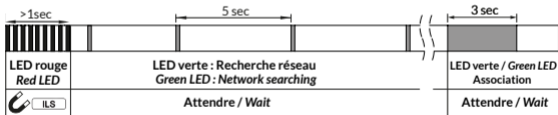

OFF

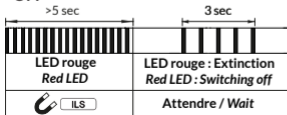

Vidéo / Video :
ON - OFF



<https://www.watteco.fr/assistance/tutoriels-video/>

2

Connectiques Connectors

PT 1000

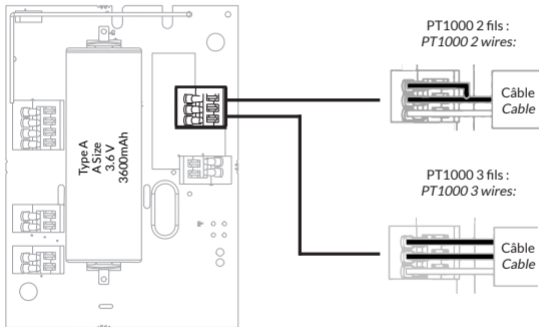

Le capteur PT1000 est livré sans sonde.
Passez le câble dans le presse étoupe

*The PT1000 sensor is supplied without a probe.
Pass the cable through the cable gland*

3

Installation Setting up

Ouverture / Fermeture
Opening / Closure

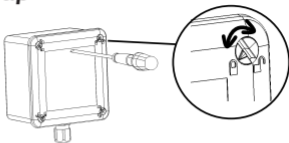

Montage mural
Wall mounting



RailDIN

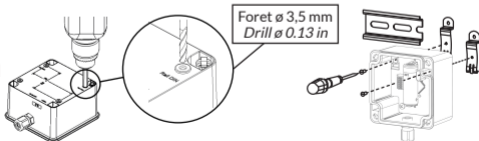

Attention, après mise en place du kit RailDIN, l'indice de protection du boîtier passe en IP50.

Please note that after installation of the RailDIN kit, the protection rating of the housing will change to IP50.

3

Installation Setting up

Attention Warning



La sonde 2 est rouge : à installer sur tuyaux chaud
Probe 2 is red : to be installed on hot pipes

La sonde 1 est bleue : à installer sur tuyaux retour
Probe 1 is blue : to be installed on return pipes

Sonde 2
Probe 2

Sonde 1
Probe 1

Prise de température sur tube *Temperature measurement on tube*

Nettoyer la zone de contact
Clean the contact area

Protection câble : Isolant thermique
Wire protection: Heat insulating

Collier en acier
Heat resistant steel clamp

Sonde
Probe

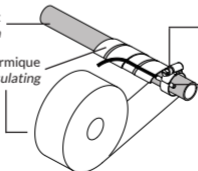

Serrer le collier sans écraser la sonde. Isoler la sonde avec le ruban.

Tighten the clamp without crushing the probe. Insulate the probe with the tape.

3

Installation Setting up

Prise de température avec un doigt de gant *Temperature measurement with the thermowell*

Nettoyer le logement intérieur du doigt de gant
Clean the inner housing of the thermowell



Vis pointeau
Needle screw

2

Pâte conductrice thermique
Thermally conductive paste

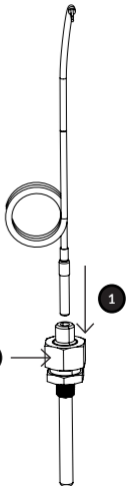

1

2

Fixer le câble sur un point d'appui avec l'aide de collier type Rilsan
Fix the cable on a support point with a Rilsan type clamp

Dimensions : Ø 5mm / Longueur 24mm
Dimensions : Ø 5mm / Length 24mm

4

Propagation radioélectrique

Radio propagation

Vérifier la couverture radio avec par exemple le Netw'O.

Check the radio coverage with the Netw'O.

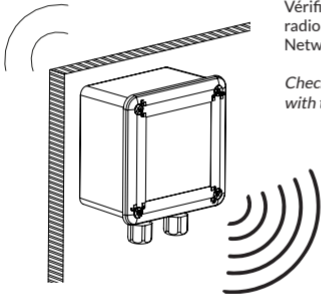
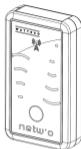

Pour que le capteur fonctionne correctement, le nombre d'obstacles doit être limité afin d'éviter une atténuation excessive des ondes radio.

For the sensor communicates correctly, the number of obstacles should be limited to avoid excessive radio attenuation.

5

Caractéristiques

Characteristics

Référence / Reference	50-70-163	50-70-126	50-70-164	50-70-043	50-70-200
Classe / Class	A	A	A	A	A
Niveau de puissance / Power Level	+14 dBm	+14 dBm	+14 dBm	+14 dBm	+14 dBm
Capacité maximum / Maximum capacity	2 sondes / 2 probes	1 sonde / 1 probe <small>(Non fournie / Not included)</small>	1 sonde / 1 probe	1 sonde / 1 probe	1 sonde / 1 probe
Mesures / Measures :					
Température / Temperature	✓	✓	✓	✓	✓
Humidité / Humidity					✓
Antenne / Antenna	Interne <i>Internal</i>	Interne <i>Internal</i>	Interne <i>Internal</i>	Interne <i>Internal</i>	Interne <i>Internal</i>
Matériaux du boîtier / Casing materials	ASA / PC	ASA / PC	ASA / PC	ASA / PC	ASA / PC
Indice de protection / IP rating	IP55	IP55	IP67	IP55	IP67



SITE SUPPORT

<https://support.watteco.com/>



CERTIFICATIONS

Watteco représenté par JC LE BLEIS, déclare que l'équipement radioélectrique du type 50-70-163 / 50-70-043 / 50-70-200/50-70-164 / 50-70-126 est conforme à la directive 2014/53/UE (RED). Le texte complet de la déclaration UE de conformité est disponible à l'adresse internet suivante: <https://www.watteco.fr/assistance/centre-de-telechargement/>

Watteco represented by JC LE BLEIS, declares that the radio equipment type 50-70-163 / 50-70-043 / 50-70-200/50-70-164 / 50-70-126 is in conformity with Directive 2014/53/EU (RED). The full text of the EU Declaration of Conformity is available at the following web address: <https://www.watteco.com/assistance/download-center/>



WATTECO

IoT device manufacturer

**Merci d'avoir choisi
les produits WATTECO**

*Thanks for choosing
WATTECO devices*