

Industrial Router Pro Series

UR32

Quick Start Guide



Safety Precautions

Milesight will not shoulder responsibility for any loss or damage resulting from not following the instructions of this operating guide.

- The device must not be modified in any way.
- Do not place the device close to objects with naked flames.
- Do not place the device where the temperature is below/above the operating range.
- Do not power on the device or connect it to other electrical device when installing.
- Check lightning and water protection when used outdoors.
- Do not connect or power the equipment using cables that have been damaged.

Related Documents

This Start Guide only explains the installation of Milesight UR32 router. For more functionality and advanced settings, please refer to the relevant documents as below.

Document	Description
UR32 Datasheet	Datasheet for UR32 industrial cellular router.
UR32 User Guide	Users could refer to the guide for instruction on how to log in the web GUI, and how to configure all the settings.

The related documents are available on Milesight website: <https://www.milesight-iot.com>

Declaration of Conformity

UR32 are in conformity with the essential requirements and other relevant provisions of the CE, FCC, and RoHS.



© 2011-2022 Xiamen Milesight IoT Co., Ltd.

All rights reserved.

All information in this guide is protected by copyright law. Whereby, no organization or individual shall copy or reproduce the whole or part of this user guide by any means without written authorization from Xiamen Milesight IoT Co., Ltd.

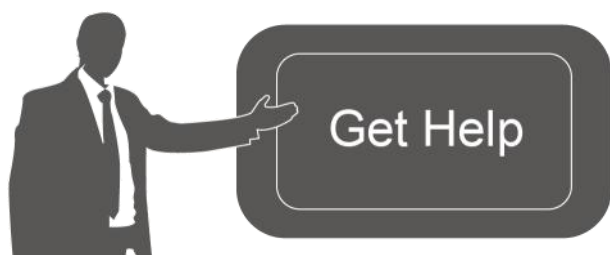

For assistance, please contact

Milesight technical support:

Email: iot.support@milesight.com

Support Portal: support.milesight-iot.com

Tel: 86-592-5085280

Fax: 86-592-5023065

Address: Building C09, Software Park III, Xiamen
361024, China

Revision History

Date	Doc Version	Description
Apr. 26, 2019	V 1.0	Initial version
May 11, 2020	V 1.1	Web interfaces upgrade
Nov. 25, 2020	V 2.0	Layout Replace
Dec. 1, 2021	V 2.1	<ol style="list-style-type: none"> 1. DI matches to GND 2. Update cellular pictures
Oct. 31, 2022	V 2.2	<ol style="list-style-type: none"> 1. Delete Ethernet cable 2. Loggin page update

Contents

- 1. Packing List 5
- 2. Hardware Introduction 6
 - 2.1 Overview 6
 - 2.2 Dimensions 6
 - 2.3 Serial & IO & Power Pinouts 7
 - 2.4 LED Indicators 7
 - 2.5 Reset Button 8
 - 2.6 Ethernet Port Indicator 8
- 3. Hardware Installation 9
 - 3.1 SIM Card/Micro SD Card Installation 9
 - 3.2 Antenna Installation 9
 - 3.3 Router Installation 9
 - 3.3.1 Wall Mounting 9
 - 3.3.2 DIN Rail Mounting 10
- 4. Log in the Web GUI 11
- 5. Network Configuration 13
 - 5.1 Ethernet WAN Configuration 13
 - 5.2 Cellular Connection Configuration 14

1. Packing List

Before you begin to install the UR32 router, please check the package contents to verify that you have received the items below.



1 x UR32

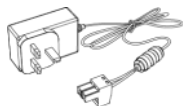

1 x Power Adapter



1 x 6-Pin Pluggable Terminal

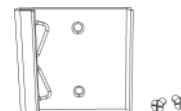

1 x DIN Rail Kit



4 x Wall Mounting Kits



2 x Magnetic Cellular Antennas



1 x Warranty Card



1 x Quick Start Guide



1 x Wi-Fi Antenna
(Wi-Fi Version Only)



1 x GPS Antenna
(GPS Version Only)



2 x Stubby Cellular Antennas
(Optional)



If any of the above items is missing or damaged, please contact your sales representative.

2. Hardware Introduction

2.1 Overview

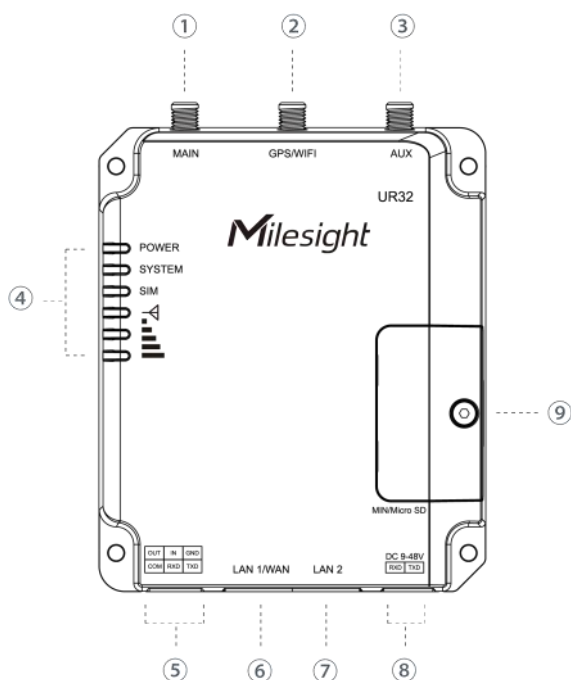

- ① Main Cellular Antenna Connector
- ② GPS/WIFI Antenna Connector
- ③ AUX Cellular Antenna
- ④ LED Indicator Area
POWER: Power Indicator
SYSTEM: Status Indicator
SIM : Status Indicator
▽ : Signal Strength Indicator
- ⑤ Serial Port & I/O
- ⑥ Ethernet LAN1/WAN Port
- ⑦ Ethernet LAN2 Port
- ⑧ Power Connector
- ⑨ SIM and Reset Button Holder

2.2 Dimensions (mm)

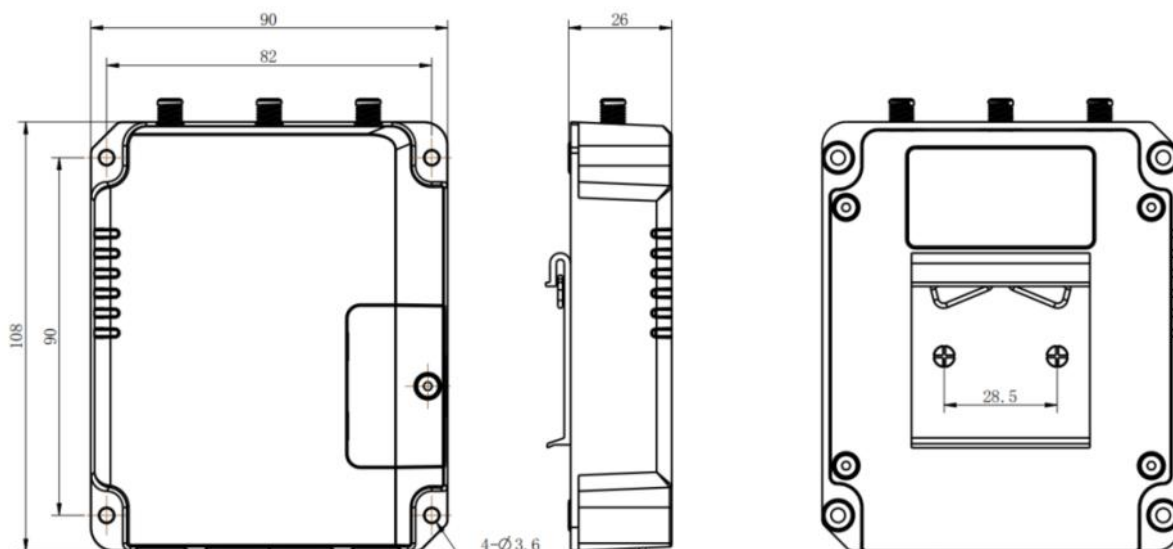

2.3 Serial & IO & Power Pinouts

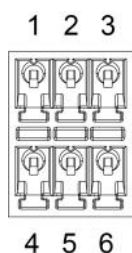

PIN	RS232 /RS485*	DI	DO	Description
1	---	---	OUT	Digital Output
2	---	IN	---	Digital Input
3	GND	GND	---	Ground
4	---		COM	Common Ground
5	RXD/B	---	---	Receive Data
6	TXD/A	---	---	Transmit Data

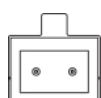

7 8

PIN	Description	Wire Color
7	Positive	Red
8	Negative	Black

*: Only for -485 model.

2.4 LED Indicators

LED	Indication	Status	Description
POWER	Power Status	Off	The power is switched off
		On	The power is switched on
SYSTEM	System Status	Green Light	Static: Start-up Blinking slowly: the system is running properly
		Red Light	The system goes wrong
SIM	SIM Card Status	Off	SIM1 or SIM2 is registering or fails to register (or there are no SIM cards inserted)
		Green Light	Blinking slowly: SIM1 has been registered and is ready for dial-up
			Blinking rapidly: SIM1 has been registered and is dialing up now
			Static: SIM1 has been registered and dialed up successfully
		Orange Light	Blinking slowly: SIM2 has been registered and is ready for dial-up
			Blinking rapidly: SIM2 has been registered and is dialing up now
Static: SIM2 has been registered and dialed up successfully			
Signal Strength	Signal 1/2/3	Off	No signal
		Green Light	Static/Off/Off: weak signals with 1-10 ASU (please check if the antenna is installed correctly, or move the

			antenna to a suitable location to get better signal)
			Static/Static/Off: normal signals with 11-20 ASU (average signal strength)
			Static/Static/Static: strong signals with 21-31 ASU (signal is good)

2.5 Reset Button

Reset button is under the SIM slots.

Function	Description	
	SYSTEM LED	Action
Reset	Blinking	Press and hold the reset button for more than 5 seconds.
	Static Green → Rapidly Blinking	Release the button and wait.
	Off → Blinking	The router is now reset to factory defaults.

2.6 Ethernet Port Indicator

Indicator	Status	Description
Link Indicator (Orange)	On	Connected
	Blinking	Transmitting data
	Off	Disconnected

3. Hardware Installation

Environmental Requirements

- Power Input: 9-48 VDC (48 VDC is needed for PoE output)
- Power Consumption: Typical 1.9 W (Max 2.4 W)
- Operating Temperature: -40°C to 70°C (-40°F -158°F)
- Relative Humidity: 0% to 95% (non-condensing) at 25°C/77°F

3.1 SIM Card/Micro SD Card Installation

A. Unscrew the cover of the SIM card then take it off.

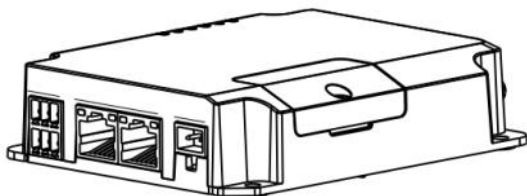

B. Put SIM card/Micro SD into the slot and screw it up.

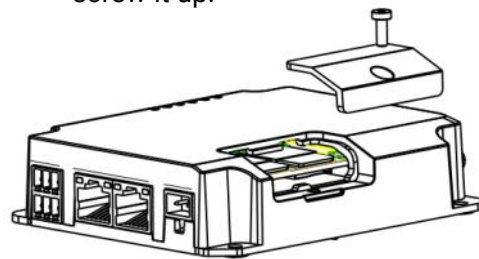

Note: UR32 does not support hot plugging (also called hot swapping). please turn off the power before you insert or take off cards.

3.2 Antenna Installation

Rotate the antenna into the antenna connector accordingly.

The external antenna should be installed vertically always on a site with a good signal.

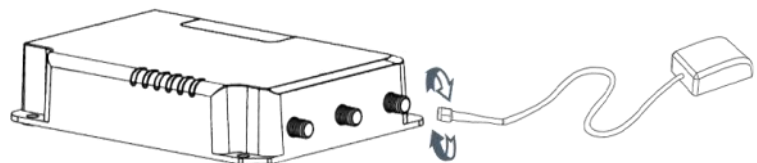
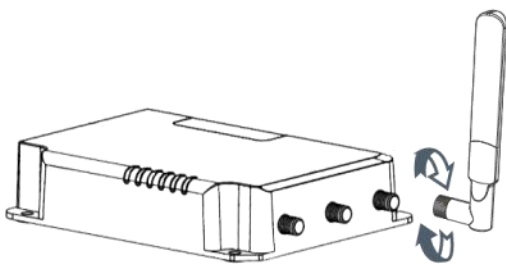

3.3 Router Installation

The router can be placed on a desktop or mounted to a wall or a DIN rail.

3.3.1 Wall Mounting (Measured in mm)

Use 4 pcs of M3 × 6 flat head Phillips screws to fix the router on the wall.

⚠ Recommended torque for mounting is 1.0 N·m, and the maximum allowed is 1.2 N·m.

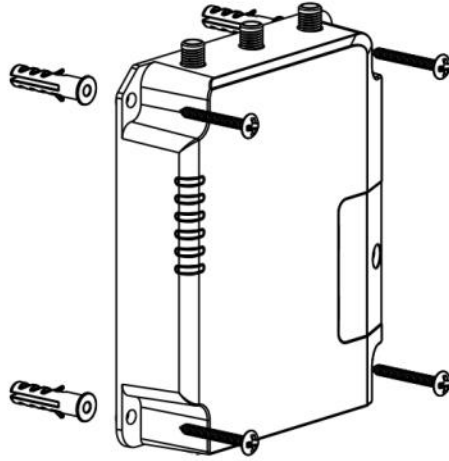

3.3.2 DIN Rail Mounting (Measured in mm)

Use 2 pcs of M3 × 6 flat head Phillips screws to fix the mount clip to the router, and then hang the device to the DIN rail. The width of DIN rail is 3.5 cm.



Recommended torque for mounting is 1.0 N·m, and the maximum allowed is 1.2 N·m.

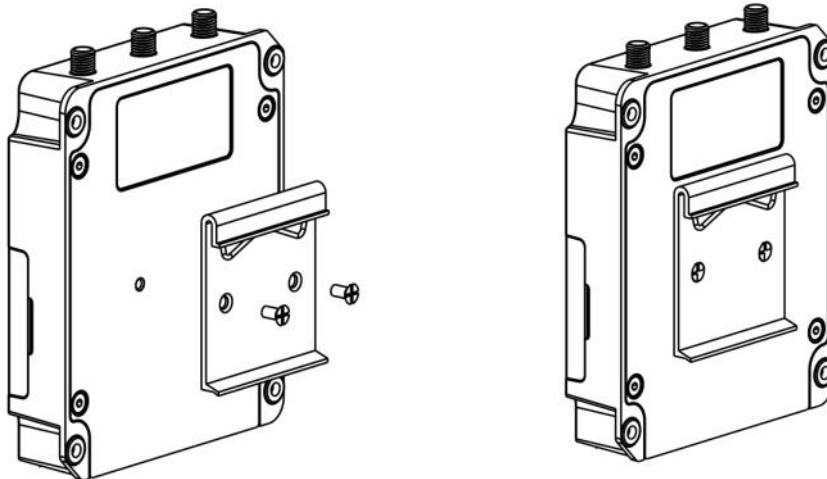

4. Log in the Web GUI

Please connect PC to LAN port of UR32 router. PC can obtain an IP address, or you can configure a static IP address manually. The following steps are based on Windows 10 operating system for your reference.

IP Address: **192.168.1.1**

Username: **admin**

Password: **password**

A. Go to “Control Panel” → “Network and Internet” → “Network and Sharing Center”, then click “Ethernet” (May have different names).

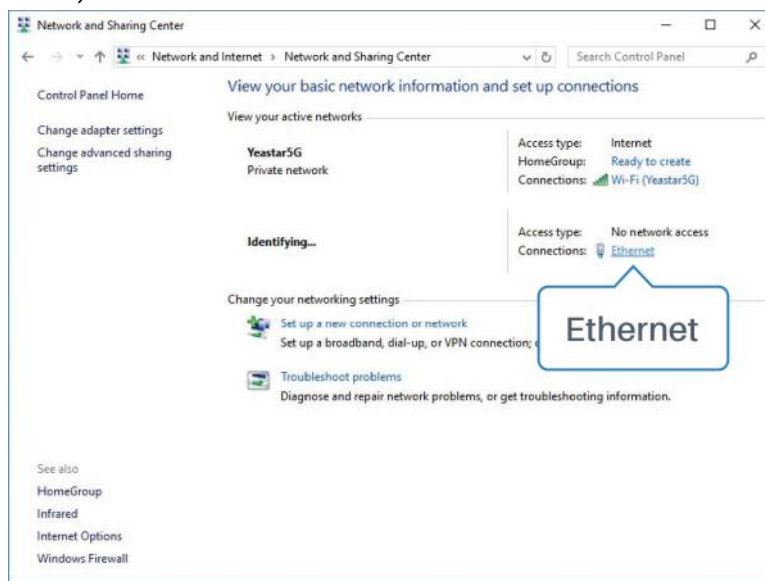

B. Go to “Properties” → “Internet Protocol Version 4(TCP/IPv4)”, select “Obtain an IP address automatically” or “Use the following IP address”, then assign a static IP manually within the same subnet of the device.

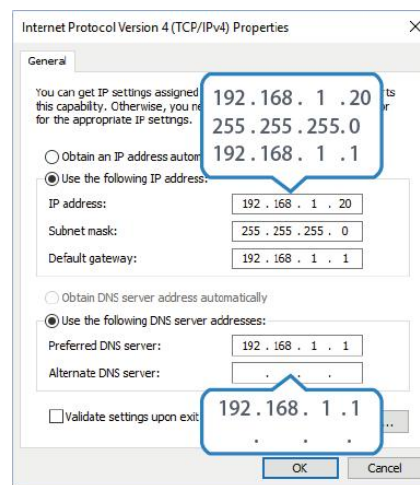
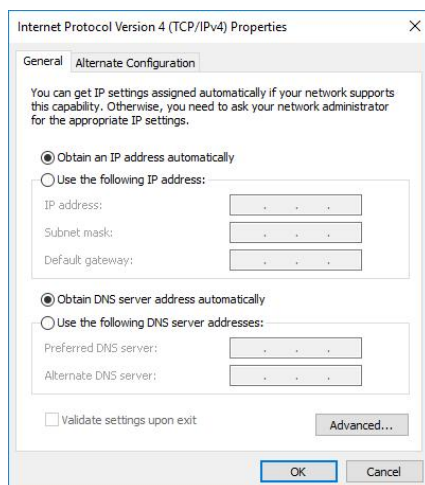

C. Open a Web browser on your PC (Chrome is recommended), type in the IP address **192.168.1.1** to access the web GUI.

D. Enter the username, password, and click "Login".

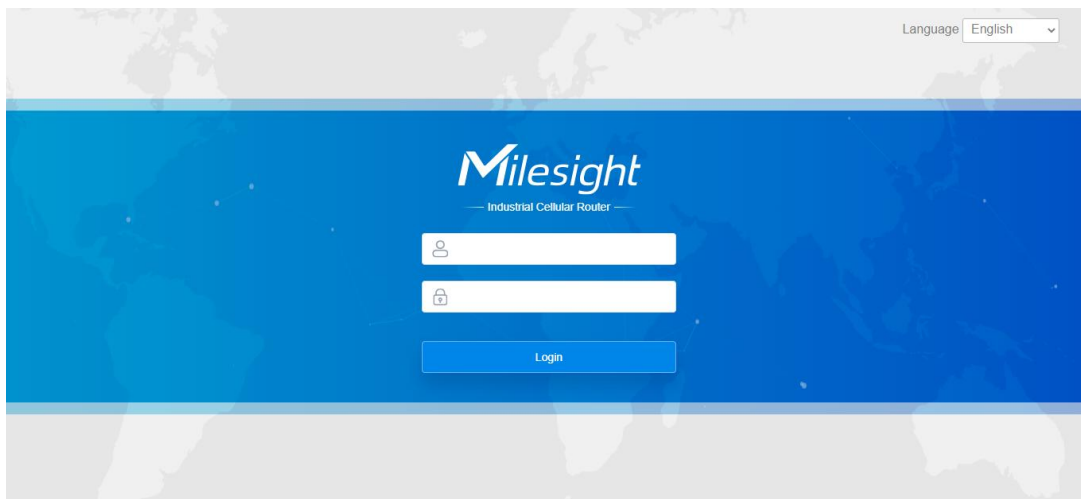

! If you enter the username or password incorrectly more than 5 times, the login page will be locked for 10 minutes.

E. When you login with the default username and password, you will be asked to modify the password. It's suggested that you change the password for the sake of security.

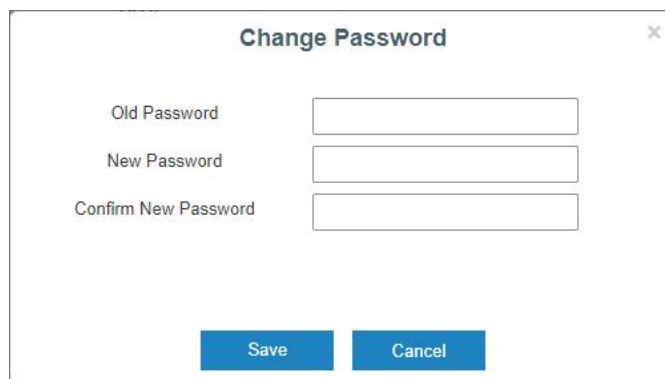

F. After you login the Web GUI, you can view system information and perform configuration on the router.

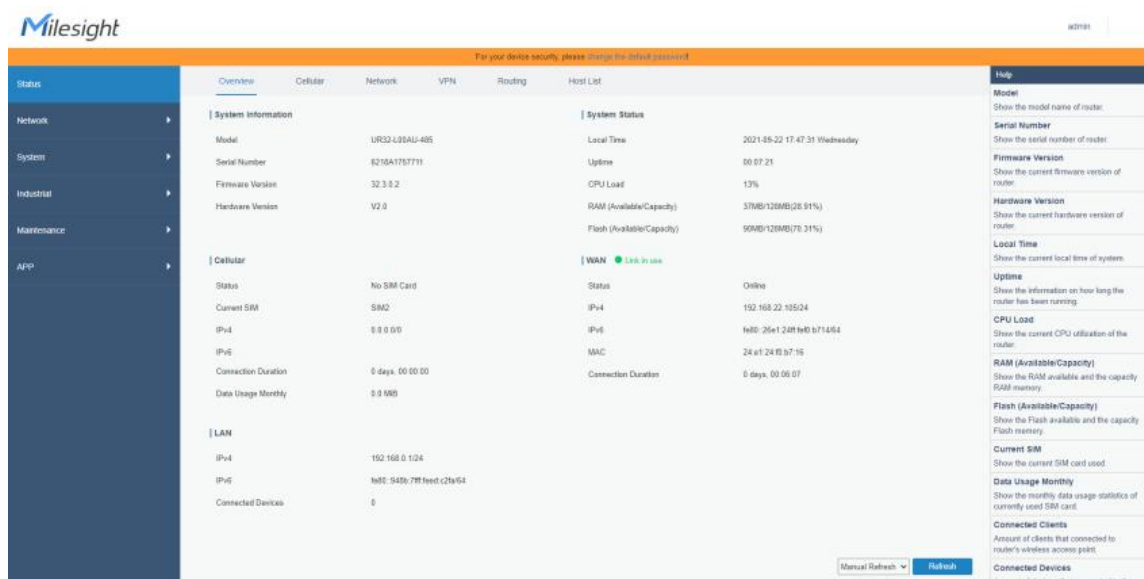

5. Network Configuration

This chapter explains how to connect UR32 to network via WAN connection or cellular.

5.1 Ethernet WAN Configuration

A. Go to “Network > Interface > Port” to change LAN1 to WAN port.

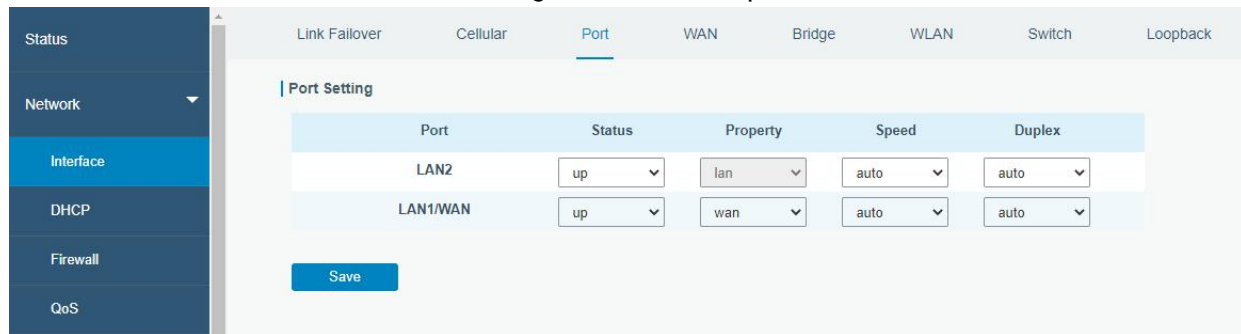

B. Go to “Network > Interface > WAN” to select connection type and configure WAN parameters, click “Save & Apply” button to make the changes take effect.

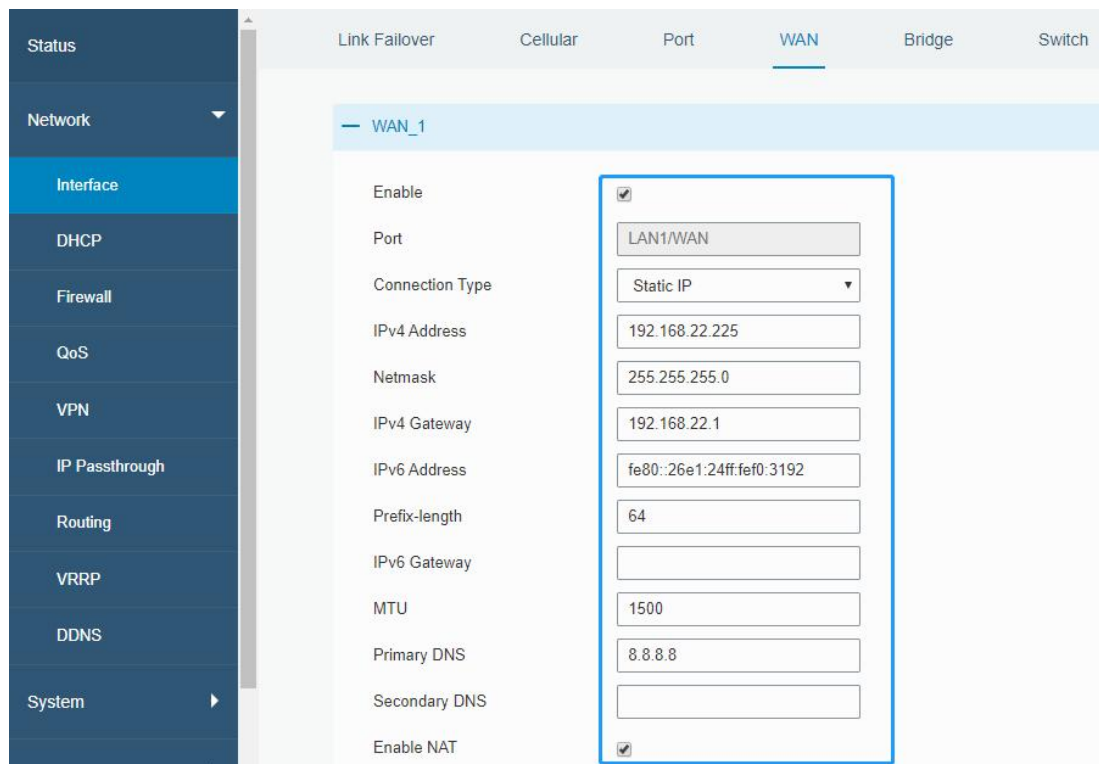

C. Connect WAN port to another network devices like modem.

D. Go to “Network > Interface > Link Failover” to rise the WAN priority to 1.

E. Open your preferred browser on PC, then type any available web address into address bar and see if it is able to visit Internet via UR32 router.

Priority	Enable Rule	Link in use	Interface	Connection Type	IP	Operation
1	<input checked="" type="checkbox"/>	●	WAN	Static IP	192.168.22.225	
2	<input checked="" type="checkbox"/>	●	Cellular-SIM1	DHCP	-	
3	<input checked="" type="checkbox"/>	●	Cellular-SIM2	-	-	

5.2 Cellular Connection Configuration

Take inserting SIM card into SIM1 slot as an example; please refer to the following detailed operations.

A. Go to “Network > Interface > Cellular > Cellular Setting” to configure APN, PIN code or other cellular info, click “Save” and “Apply” to save the configuration.

	SIM1	SIM2
Protocol Type	IPv4	IPv4
APN		
Username		
Password		
PIN Code		
Access Number		
Authentication Type	Auto	Auto
Network Type	Auto	Auto
PPP Preferred	<input type="checkbox"/>	<input type="checkbox"/>
SMS Center		
Enable NAT	<input checked="" type="checkbox"/>	<input checked="" type="checkbox"/>

B. Go to “Network > Interface > Link Failover” to enable SIM1 and rise link priority of SIM1.

Priority	Enable Rule	Link in use	Interface	Connection Type	IP	Operation
1	<input checked="" type="checkbox"/>	●	Cellular-SIM1	-	-	
2	<input checked="" type="checkbox"/>	●	Cellular-SIM2	DHCP	-	
3	<input checked="" type="checkbox"/>	●	WAN	Static IP	192.168.22.225	

C. Click to configure ICMP ping detection information.

Ping Detection

Enable	<input checked="" type="checkbox"/>
IPv4 Primary Server	<input type="text" value="8.8.8.8"/>
IPv4 Secondary Server	<input type="text" value="114.114.114.114"/>
IPv6 Primary Server	<input type="text" value="2001:4860:4860::8888"/>
IPv6 Secondary Server	<input type="text" value="2400:3200::1"/>
Interval	<input type="text" value="300"/> s
Retry Interval	<input type="text" value="5"/> s
Timeout	<input type="text" value="3"/> s
Max Ping Retries	<input type="text" value="3"/>

D. Click “Status > Cellular” to view the status of the cellular connection. If it shows “Connected”, it means SIM1 has dialed up successfully. On the other hand, you can check the status of SIM indicator. If it keeps on green light statically, it means SIM1 has dialed up successfully.

Overview	Cellular	Network	VPN	Routing	Host List	GPS
Modem		Network				
Status	Ready	Status			Connected	
Model	EC25	IP Address			10.2.25.74	
Current SIM	SIM1	Netmask			255.255.255.240	
Signal Level	29asu (-55dBm)	Gateway			10.2.25.73	
Register Status	Registered (Home network)	DNS			211.136.17.107	
IMEI	861585042050250	Connection Duration			0 days, 00:00:34	
IMSI	460045927703654	Data Usage Monthly				
ICCID	89860439101880723654	SIM-1			RX: 0.0 MIB TX: 0.0 MIB ALL: 0.0 MIB	
ISP	CHINA MOBILE	SIM-2			RX: 0.0 MIB TX: 0.0 MIB ALL: 0.0 MIB	
Network Type	FDD LTE					
PLMN ID	46000					
LAC	592f					
Cell ID	271f648					

E. Open your preferred browser on PC, then type any available web address into address bar and see if it is able to visit Internet via UR32 router.

[END]