

UR 75

Industrial Cellular Router User Guide

Xiamen Ursalink Technology Co., Ltd.



Preface

Thanks for choosing Ursalink UR75 industrial cellular router. The UR75 industrial cellular router delivers tenacious connection over network with full-featured design such as automated failover/failback, extended operating temperature, dual SIM cards, hardware watchdog, VPN, Gigabit Ethernet and beyond. This guide describes how to configure and operate the UR75 industrial cellular router. You can refer to it for detailed functionality and router configuration.

Readers

This guide is mainly intended for the following users:

- Network Planners
- On-site technical support and maintenance personnel
- Network administrators responsible for network configuration and maintenance

© 2017 Xiamen Ursalink Technology Co., Ltd.

All rights reserved.

All information in this user guide is protected by copyright law. Whereby, no organization or individual shall copy or reproduce the whole or part of this user guide by any means without written authorization from Xiamen Ursalink Technology Co., Ltd.

Products Covered

This guide explains how to configure the following devices:

- Ursalink UR75 Industrial Cellular Router

Related Documents

Document	Description
Ursalink UR75 Datasheet	Datasheet for the Ursalink UR75 industrial cellular router.
Ursalink UR75 Quick Start Guide	Quick Installation guide for the Ursalink UR75 series industrial cellular router.

Declaration of Conformity

UR75 is in conformity with the essential requirements and other relevant provisions of the CE, FCC, and RoHS.

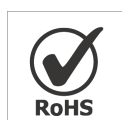

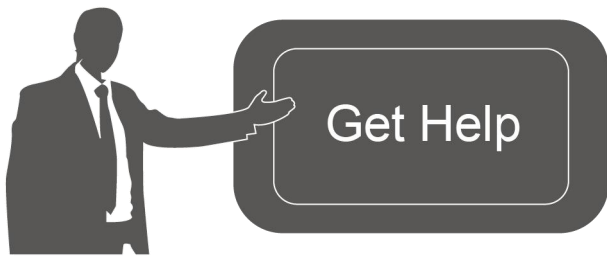

For assistance, please contact
Ursalink technical support:
Email: support@ursalink.com
Tel.: 86-592-5023060
Fax: 86-592-5023065

Revision History

Date	Doc Version	Description
Nov. 14, 2017	V.1.0.0	Initial version

Contents

Chapter 1 Product Introduction	8
1.1 Overview	8
1.2 Advantages	8
1.3 Specifications	10
1.4 Dimensions (mm)	12
Chapter 2 Installation	13
2.1 General Packing List	13
2.2 Product Overview	14
2.3 LED Indicators	14
2.5 PIN Definition	15
2.6 Reset Button	16
2.7 SIM Card Installation	16
2.8 Micro SD card/ SSD Installation	17
2.8.1 Micro SD Card Installation	17
2.8.2 SSD Installation	18
2.9 Antenna Installation	18
2.10 Mounting the Router	19
2.11 Connect the Router to a Computer	19
2.12 Installation of Power Supply and Protective Grounding	20
2.12.1 Power Supply Installation	20
2.12.2 Protective Grounding Installation	20
Chapter 3 Access to Web GUI	21
3.1 PC Configuration for Web GUI Access to Router	21
3.2 Access to Web GUI of Router	22
Chapter 4 Web Configuration	24
4.1 Status	24
4.1.1 Overview	24
4.1.2 Cellular	24
4.1.3 Network	26
4.1.4 WLAN (Only Applicable to Wi-Fi Version)	27
4.1.5 VPN	29
4.1.6 Routing Information	30
4.1.7 Host List	31
4.1.8 GPS	31
4.2 Network	32
4.2.1 Interface	32
4.2.1.1 Port	32
4.2.1.2 WAN	33
4.2.1.3 LAN	37
1. LAN Settings	37
2. VLAN Settings	37
4.2.1.4 WLAN (Only Applicable to Wi-Fi Version)	38

4.2.1.5 Cellular.....	40
4.2.1.7 Loopback.....	43
4.2.2 Firewall.....	44
4.2.2.1 ACL.....	44
4.2.2.2 DMZ.....	45
4.2.2.3 Port Mapping.....	46
4.2.2.4 MAC Binding.....	47
4.2.3 QoS.....	47
4.2.3.1 QoS (Download/Upload).....	48
4.2.4 DHCP.....	49
4.2.4.1 DHCP Server.....	49
4.2.4.2 DHCP Relay.....	50
4.2.5 DDNS.....	51
4.2.6 Link Failover.....	52
4.2.6.1 SLA.....	52
4.2.6.2 Track.....	53
4.2.6.3 VRRP.....	54
4.2.6.4 WAN Failover.....	56
4.2.7 Routing.....	57
4.2.7.1 Static Routing.....	57
4.2.7.2 RIP.....	58
4.2.7.3 OSPF.....	62
4.2.7.4 Routing Filtering.....	67
4.2.8 VPN.....	67
4.2.8.1 DMVPN.....	68
4.2.8.2 IPSec.....	69
4.2.8.3 GRE.....	72
4.2.8.4 L2TP.....	73
4.2.8.5 PPTP.....	76
4.2.8.6 OpenVPN Client.....	78
4.2.8.7 OpenVPN Server.....	80
4.2.8.8 Certifications.....	82
4.3 System.....	83
4.3.1 General Settings.....	83
4.3.1.1 General.....	83
4.3.1.2 Account Management.....	85
4.3.1.3 System Time.....	85
4.3.1.4 SMTP.....	87
4.3.1.5 Phone.....	88
4.3.1.6 Storage.....	89
4.3.2 User Management.....	90
4.3.3 SNMP.....	90
4.3.3.1 SNMP.....	91
4.3.3.2 MIB View.....	91

4.3.3.3 VACM.....	92
4.3.3.4 Trap.....	93
4.3.3.5 MIB.....	93
4.3.4 AAA.....	94
4.3.4.1 Radius.....	94
4.3.4.2 TACACS+.....	94
4.3.4.3 LDAP.....	95
4.3.4.4 Authentication.....	96
4.3.5 Device Management.....	97
4.3.6 Events.....	97
4.3.6.1 Events.....	97
4.3.6.2 Events Settings.....	98
4.4 Industrial Interface.....	99
4.4.1 I/O.....	100
4.4.1.1 DI.....	100
4.4.1.2 DO.....	101
4.4.2 Serial Port.....	102
4.4.3 Modbus TCP.....	105
4.4.3.1 Modbus TCP.....	106
4.4.4 Modbus Master.....	106
4.4.4.1 Modbus Master.....	106
4.4.4.2 Channel.....	107
4.4.5 GPS.....	110
4.4.5.1 GPS.....	110
4.4.5.2 GPS IP Forwarding.....	110
4.4.5.3 GPS Serial Forwarding.....	111
4.5 Maintenance.....	112
4.5.1 Tools.....	112
4.5.1.1 Ping.....	112
4.5.1.2 Traceroute.....	113
4.5.2 Schedule.....	114
4.5.3 Log.....	114
4.5.3.1 System Log.....	114
4.5.3.2 Log Settings.....	115
4.5.4 Upgrade.....	116
4.5.5 Backup and Restore.....	117
4.5.6 Reboot.....	118
4.6 APP.....	118
4.6.1 Python.....	118
4.6.1.1 Python.....	119
4.6.1.2 App Manager Configuration.....	120
4.6.1.3 Python App.....	120
Chapter 5 Application Examples.....	122
5.1 Account Info Management.....	122

5.2 Common User Management	122
5.3 System Time Management	123
5.4 Backup and Restore Configuration	125
5.5 Restore Factory Defaults	126
5.5.1 Via Web Interface	126
5.5.2 Via Hardware	127
5.6 Firmware Upgrade	128
5.7 Events Application Example	130
5.8 Schedule Application Example	131
5.9 Logs and Diagnostics	132
5.10 SNMP Application Example	133
5.11 LAN Management	136
5.12 Network Connection	137
5.12.1 Cellular Connection	137
5.12.2 Ethernet WAN Connection	139
5.13 WAN Failover/Backup Application Example	142
5.13.1 Dual SIM Backup	142
5.13.2 WAN Failover	144
5.14 Wi-Fi Application Example (Only Applicable to Wi-Fi Version)	148
5.14.1 AP Mode	148
5.14.2 Client Mode	149
5.15 VRRP Application Example	151
5.16 Static Routing Application Example	156
5.17 Dynamic Routing Application Example	157
5.18 NAT Application Example	160
5.19 Access Control Application Example	160
5.20 QoS Application Example	162
5.21 DTU Application Example	162
5.22 PPTP Application Example	166

Chapter 1 Product Introduction

1.1 Overview

Ursalink UR75 is an industrial cellular router with embedded intelligent software features that are designed for multifarious M2M/IoT applications. Supporting global WCDMA and 4G LTE, UR75 provides drop-in connectivity for operators and makes a giant leap in maximizing uptime.

Adopting high-performance and low-power consumption industrial platform of 64-bit CPU and wireless module, the UR75 is capable of providing wire-speed network with a typical 4 W power consumption and ultra-small package to ensure the extremely safe and reliable connection to the wireless network.

Meanwhile, the UR75 also supports Gigabit Ethernet ports, serial port (RS232/RS485) and I/O (input/output), which enables you to scale up M2M application combining data and video in limited time and budget.

The UR75 is particularly ideal for smart grid, digital media installations, industrial automation, telemetry equipment, medical device, digital factory, finance, payment device, environment protection, water conservancy and so on.

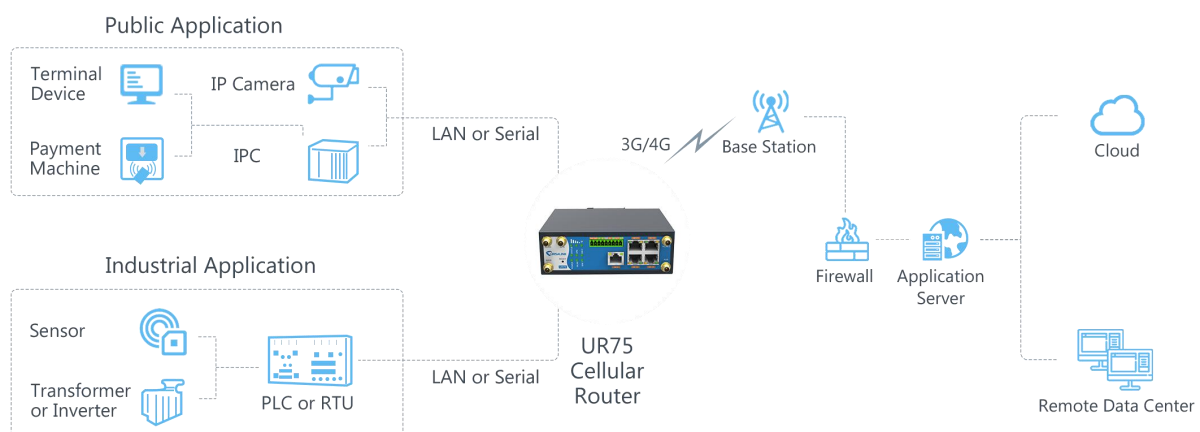

Figure 1-1

1.2 Advantages

Benefits

- Built-in industrial strong CPU, big memory; SSD/Micro SD card is available to support further development and customized requirements
- Gigabit Ethernet is applied to all models of Ursalink routers for lightning transmission of data
- Dual SIM cards for backup between multiple carriers networking and global 3G/LTE options make it easy to get connected
- Embed Ursalink SDK (Python 2.7/C) for secondary development
- Flexible modular design provides users with different connection modules like Ethernet, I/O, serial port, Wi-Fi, GPS for connecting diverse field assets
- Rugged enclosure, optimized for DIN rail or shelf mounting
- 3-year warranty included

Security & Reliability

- Automated failover/failback between Ethernet and Cellular (dual SIM)
- Enable unit with security frameworks like IPsec/OpenVPN/GRE/L2TP/PPTP/ DMVPN
- Embed hardware watchdog, able to automatically recover from various failure, ensure highest level of availability
- Establish a secured mechanism on centralized authentication and authorization of device access by supporting AAA (TACACS+, Radius, LDAP, local authentication) and multiple levels of user authority
-

Easy Maintenance

- Ursalink DeviceHub provides easy setup, mass configuration, and centralized management of remote devices
- The user-friendly web interface design and more than one option of upgrade help administrator to manage the device as easy as pie
- WEB GUI and CLI enable the admin to achieve simple management and quick configuration among a large quantity of devices
- Efficiently manage the remote routers on the existing platform through the industrial standard SNMP

Capabilities

- Link remote devices in an environment where communication technologies are constantly changing
- Industrial 64-bit ARM Cortex-A53 processor, high-performance operating up to 800MHz with low power consumption below 1W, and 256 MB memory available to support more applications
- Support max. 512GB SSD interface
- Support rich protocols like SNMP, MQTT, Modbus bridging, RIP, OSPF
- Support wide operating temperature ranging from -40°C to 70°C/-40°F to 158°F

1.3 Specifications

Cellular Interfaces	
Connectors	2 × 50 Ω SMA (Center pin: female)
SIM Slots	2
Wi-Fi Interface (Optional)	
Connectors	2 × 50 Ω SMA (Center pin: female)
Standards	IEEE 802.11b/g/n/ac
Tx Power	802.11b: 15dBm ± 2dBm@11Mbps 802.11g: 13dBm ± 2dBm@54Mbps 802.11gn HT20: 12dBm ± 2dBm@MCS7 802.11gn HT40: 11dBm ± 2dBm@MCS7 802.11an HT20: 11dBm ± 2dBm@MCS7 802.11an HT40: 10dBm ± 2dBm@MCS7 802.11ac(HT80): 4dBm ± 2dBm@MCS9
Rx Sensitivity	802.11b: ≤ -76dBm@54Mbps 802.11g: ≤ -65dBm@54Mbps 802.11gn HT20: ≤ -64dBm@MCS7 802.11gn HT40: ≤ -61dBm@MCS7 802.11an HT20: ≤ -64dBm@MCS7 802.11an HT40: ≤ -61dBm@MCS7 802.11ac (HT80): ≤ -51dBm@MCS9
Modes	Access point, support for multiple SSID, support AP and Client mode
Security	WPA/WPA2 authentication, WEP/TKIP/AES encryption
Hardware System	
CPU	800MHz, 64-bit ARM Cortex-A53
Memory	64 MB Flash, 256 MB DDR3 RAM
Storage	1 × Micro SD, 1 × M.2 slot supports SATA M.2 SSD (22 x 42 mm) up to 512 GB
Ethernet	
Ports	5 × RJ-45
Physical Layer	10/100/1000 Base-T (IEEE 802.3)
Data Rate	10/100/1000 Mbps (auto-sensing)
Interface	Auto MDI/MDIX

Mode	Full or half duplex (auto-sensing)
Serial Interface	
Ports	1 × RS232 + 1 × RS485 or 2 × RS232 or 2 × RS485
Connector	Terminal block
Baud Rate	300bps to 230400bps
IO	
Connector	(4) pin screw down terminal block
Digital	2 × DI + 2 × DO
Software	
Network Protocols	PPP, PPPoE, SNMP v1/v2c/v3, TCP, UDP, DHCP, RIPv1/v2, OSPF, DDNS, VRRP, HTTP, HTTPS, DNS, ARP, QOS, SNTP, Telnet, VLAN, SSH, etc.
VPN Tunnel	DMVPN/IPsec/OpenVPN/PPTP/L2TP/GRE
Access Authentication	CHAP/PAP/MS-CHAP/MS-CHAPV2
Firewall	ACL/DMZ/Port Mapping/MAC Binding
Management	Web, CLI, SMS, On-demand dial up
AAA	Radius, TACACS+, LDAP, Local Authentication
Multilevel Authority	Multiple levels of user authority
Reliability	VRRP, WAN Failover, Dual SIM Backup
Serial Port	Transparent (TCP Client/Server, UDP), Modbus Gateway (Modbus RTU to Modbus TCP)
Power Supply and Consumption	
Connector	2-pin with 5.08 mm terminal block
Input Voltage	9-48 VDC
Power Consumption	Typical 4.0 W (Max 6.7 W)
Physical Characteristics	
Ingress Protection	IP30
Housing & Weight	Metal, 492 g (1.08 lb)
Dimensions	132 x 103.8 x 45 mm (5.20 x 4.09 x 1.77 in)
Mounting	Desktop, wall or DIN rail mounting
Others	
Reset Button	1 × RESET
LED Indicators	1 × POWER, 1 × WLAN, 1 × STATUS, 1 × VPN, 1 × SIM1, 1 × SIM2, 3 × Signal strength
Built-in	Watchdog, RTC, Timer

Certifications	RoHS, CE, FCC
EMC	IEC 61000-4-2 Level 3
	IEC 61000-4-3 Level 3
	IEC 61000-4-4 Level 4
	IEC 61000-4-5 Level 4
	IEC 61000-4-6 Level 3
	IEC 61000-4-8 Level 4
Environmental	
Operating Temperature	-40°C to +70°C (-40°F to +158°F) Reduced cellular performance above 60°C
Storage Temperature	-40°C to +85°C (-40°F to +185°F)
Ethernet Isolation	1.5 kV RMS
Relative Humidity	0% to 95% (non-condensing) at 25°C/77°F

1.4 Dimensions (mm)

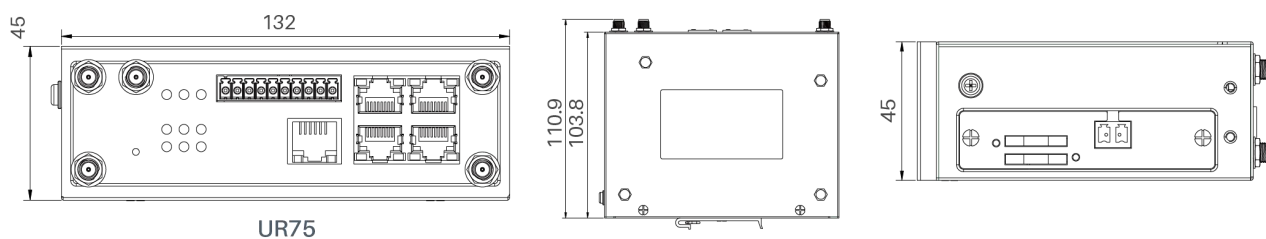

Figure 1-2

Chapter 2 Installation

2.1 General Packing List

Before you begin to install the UR75 router, please check the package contents to verify that you have received the items below.



1 × UR75 Router



1 × Ethernet Cable

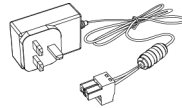

1 × Power Adapter



2 × SIM Card Slots



1 × 2-PIN Pluggable Terminal

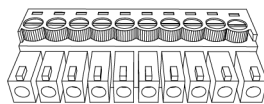

1 × 10-PIN Pluggable Terminal



1 × Warranty Card

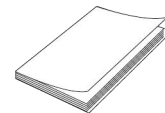

1 × Quick Start Guide



2 × Magnetic Mount Cellular Antennas (Default)



2 × Stubby Cellular Antennas (Optional)



2 × Stubby Wi-Fi Antennas (Optional)



1 × GPS Antenna

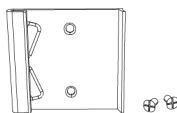

1 × DIN Rail Kit (Default)

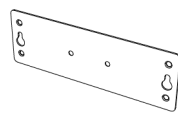

1 × Wall Mounting Bracket (Optional)



If any of the above items is missing or damaged, please contact your Ursalink sales representative.

2.2 Product Overview

A. Front Panel

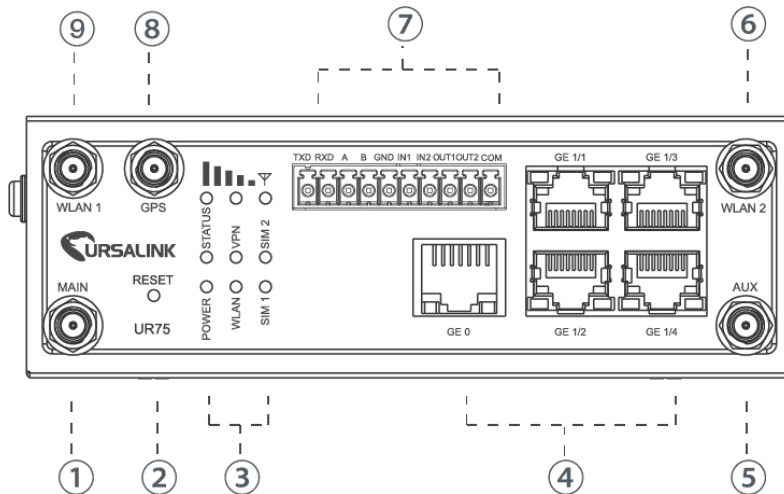

- ① Main Cellular Antenna Connector
- ② Reset Button
- ③ LED Indicator Area
 POWER: Power Indicator
 STATUS: Status Indicator
 WLAN: Wi-Fi Indicator
 VPN: VPN Indicator
 SIM 1: SIM 1 Status Indicator
 SIM 2: SIM 2 Status Indicator
 📶: Signal Strength Indicator
- ④ Ethernet Port Indicator
 Orange for data transmission;
 Green for network rate
- ⑤ AUX Cellular Antenna Connector
- ⑥ WLAN 2: Wi-Fi Antenna Connector 2
- ⑦ Serial Port & I/O
- ⑧ GPS Antenna Connector
- ⑨ WLAN 1: Wi-Fi Antenna Connector 1

B. Left Side Panel

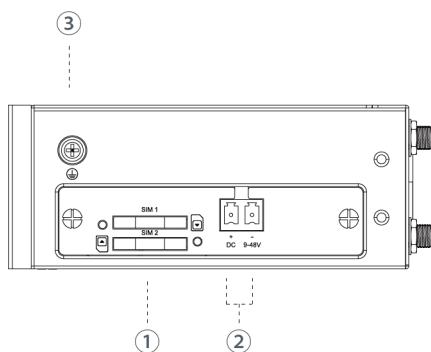

- ① SIM Card Slot
- ② Power Connector
- ③ Grounding Stud

2.3 LED Indicators

LED	Indication	Status	Description
POWER	Power Status	On	The power is switched on
		Off	The power is switched off
STATUS	System Status	Green Light	Static: Start-up
		Blinking slowly	the system is running properly
		Red Light	The system goes wrong
VPN	VPN	Green Light	VPN is connected

	Status	Off	VPN is disconnected
WLAN (Wi-Fi)	WLAN Status	Green Light	Static: Wi-Fi is enabled Blinking slowly: sending or receiving data via Wi-Fi
		Off	Wi-Fi is disabled
SIM1/SIM 2	SIM Card Status	Off	SIM1 or SIM2 is registering or fails to register (or there are no SIM cards inserted)
		Green Light	Blinking slowly: SIM1 or SIM2 has been registered and is ready for dial-up
			Blinking rapidly: SIM1 or SIM2 has been registered and is dialing up now
Signal Strength	Signal 1/2/3	Off	No signal
		Green Light	Static/Off/Off: weak signal with 1-10 ASU (please check if the antenna is installed correctly or move the antenna to a suitable location to get better signal)
			Static/Static/Off: normal signal with 11-20 ASU. (average signal strength)
			Static/Static/Static: strong signal with 21-31 ASU (signal is good)

2.4 Ethernet Port Indicators

Indicator	Status	Description
Link Indicator (Orange)	On	Connected
	Blinking	Transmitting data
	Off	Disconnected
Rate Indicator (Green)	On	1000 Mbps mode
	Off	100 Mbps mode

2.5 PIN Definition

TXD RXD A B GND IN1 IN2 OUT1 OUT2 COM

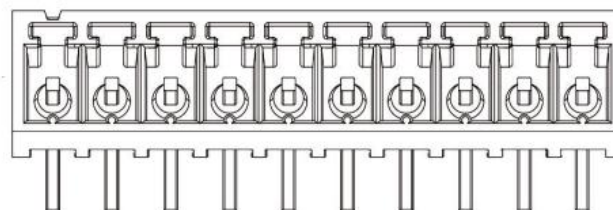

PIN	RS232	RS485	DI	DO	Description
1	TXD	---	---	---	Transmit Data
2	RXD	---	---	---	Receive Data
3	---	A	---	---	Data +
4	---	B	---	---	Data -
5	GND	---	GND	---	Ground
6	---	---	IN1	---	Digital Input1
7	---	---	IN2	---	Digital Input2
8	---	---	---	OUT1	Digital Output1
9	---	---	---	OUT2	Digital Output2
10	---	---	---	COM	Common Ground

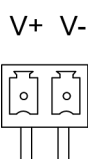

PIN	Description
11	Positive
12	Negative

2.6 Reset Button

Function	Description	
	STATUS LED	Action
Reboot	Blinking	Press and hold the reset button for about 5-15 seconds.
	Static Green	Release the button and wait for system to reboot.
Reset	Blinking	Press and hold the reset button for more than 15 seconds.
	Static Green → Rapidly Blinking	Release the button and wait.
	Off → Blinking	The router is now reset to factory defaults.

2.7 SIM Card Installation

A. Push the yellow button on left panel of the router, and then you will see the SIM card slot popping out directly.

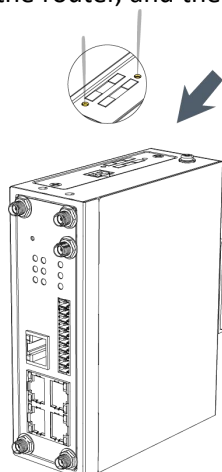

B. Put SIM card onto the slot, and then insert the slot back into the hole.

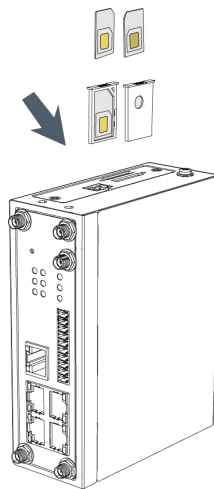

2.8 Micro SD card/ SSD Installation

2.8.1 Micro SD Card Installation

A. Unscrew the cover on left panel of the router and then take it off.

B. Insert Micro SD card.

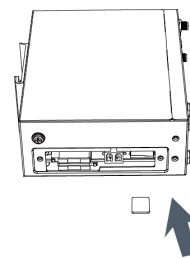
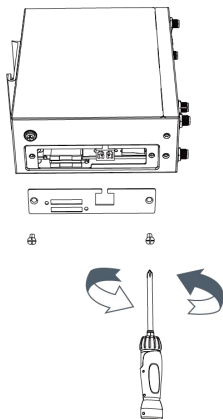

C. Close the cover and screw it back to the router.

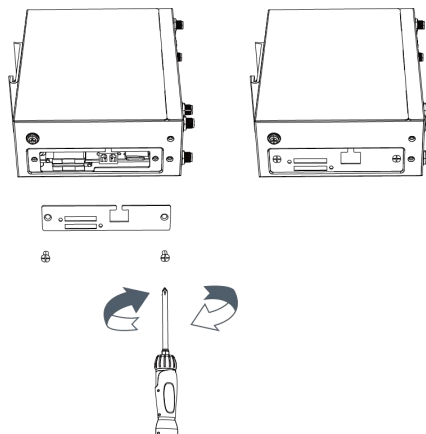

2.8.2 SSD Installation

! Before installing SSD, please turn off the power.

A. Unscrew the enclosure, and then remove the cover.

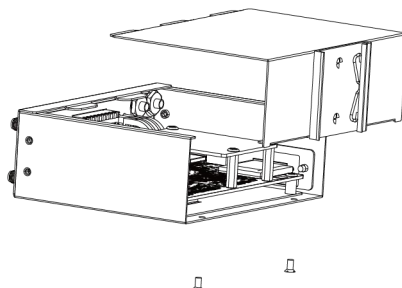

B. Unscrew the main-board, find the interface on the rear side of the main-board and then insert SSD.

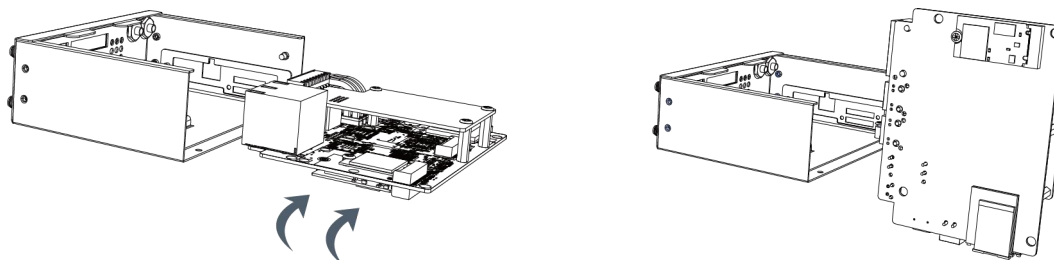

C. Screw the main-board on the cabinet and close the cover.

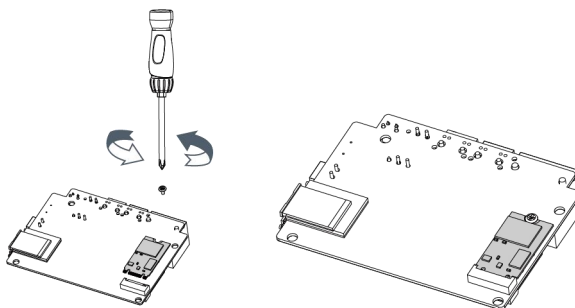

2.9 Antenna Installation

Rotate the antenna into the antenna connector accordingly.

! The external cellular antenna should be installed vertically always on a site with a good cellular signal.

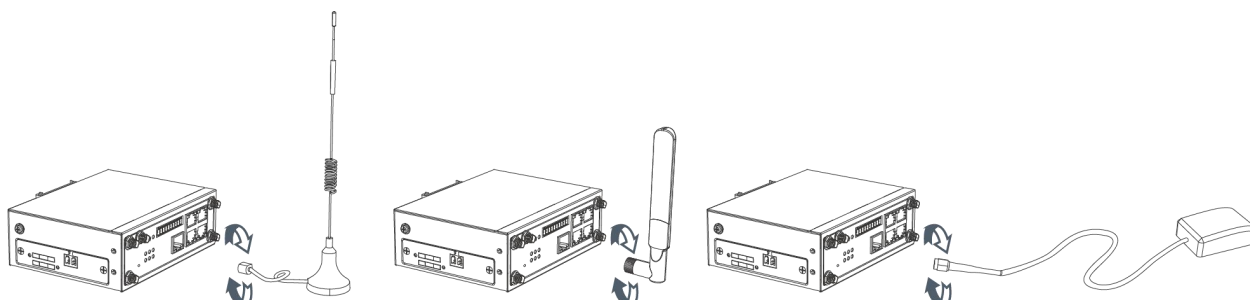

Note: UR75 router supports dual antennas with “Main” and “AUX” connectors. “Main” interface is for data receiving and transmission. “AUX” interface is for enhancing signal strength, which cannot be used separately.

2.10 Mounting the Router

The router can be placed on a desktop or mounted to a wall or a DIN rail.

2.10.1 Wall Mounting (Measured in mm)

Use 2 pcs of M3×6 flat head Phillips screws to fix the wall mounting kit to the router, and then use 2 pcs of M3 drywall screws to mount the router associated with the wall mounting kit on the wall.

⚠ Recommended torque for mounting is 1.0 N. m, and the maximum allowed is 1.2 N.m.

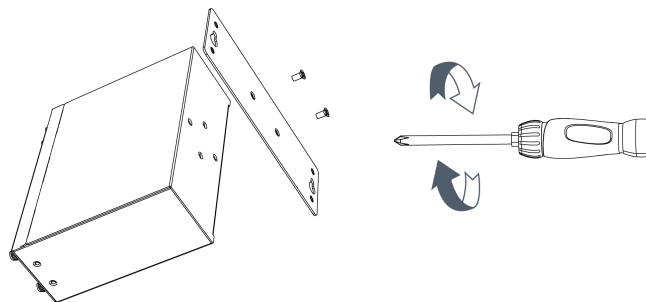

2.10.2 DIN Rail Mounting (Measured in mm)

Use 2 pcs of M3×6 flat head Phillips screws to fix the DIN rail to the router, and then hang the DIN rail on the mounting bracket. It is necessary to choose a standard bracket.

⚠ Recommended torque for mounting is 1.0 N. m, and the maximum allowed is 1.2 N.m.

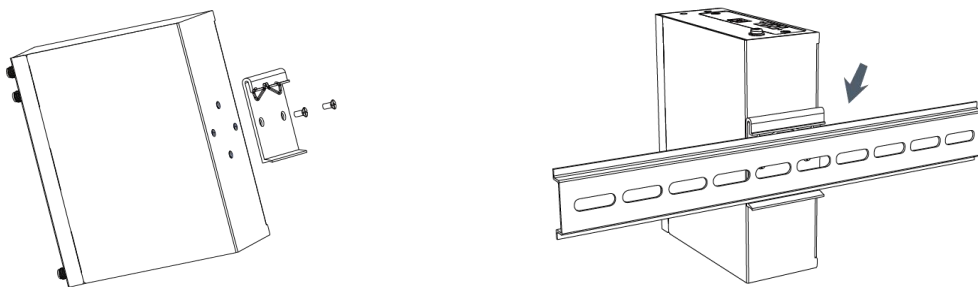

2.11 Connect the Router to a Computer

Please connect PC to any port among GE 1/1-GE1/4 of UR75 router with Ethernet cable directly.

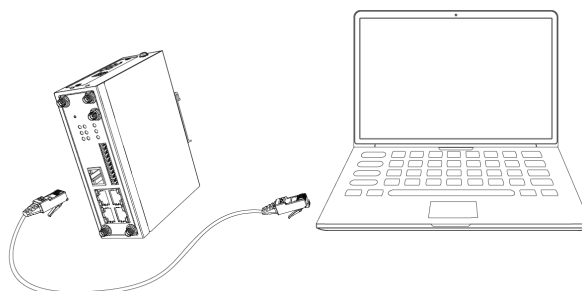

2.12 Installation of Power Supply and Protective Grounding

2.12.1 Power Supply Installation

- A. Take out the terminal from the router and unscrew the bolt on terminal.
- B. Screw down the bolt after inserting power cable into the terminal.

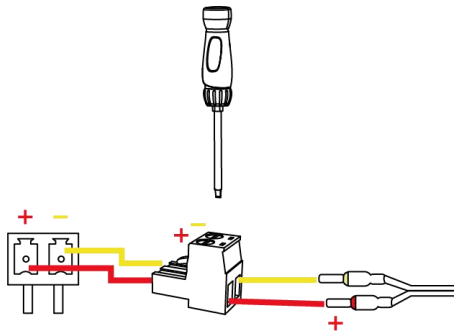

Connecting the Power Cable

Color	Polarity
Red	+
Yellow	-



If you insert wires into the reverse holes, the router will not start and you must switch the wires into the correct holes.

2.12.2 Protective Grounding Installation

1. Remove the grounding nut.
2. Connect the grounding ring of the cabinet's grounding wire onto the grounding stud and screw up the grounding nut.

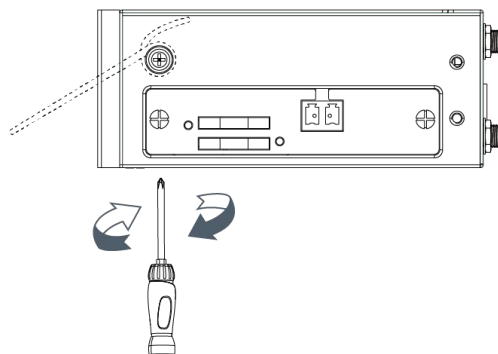

The router must be grounded when deployed. According to operating environment, the ground wire should be connected with grounding stud of router

2.13 Examine

1. Double check antenna connection.
2. Double check if SIM card is inserted and become available.
3. Power on the UR75 industrial cellular router and check indicators status.
 - (1) If Status LED blinks slowly, the system is running properly.
 - (2) If SIM1 or SIM2 indicator is static green, the router is connected to network already.

Chapter 3 Access to Web GUI

This chapter explains how to access to Web GUI of the UR75 router.

3.1 PC Configuration for Web GUI Access to Router

Please connect PC to any port among GE 1/1-GE 1/4 of UR75 router directly. PC can obtain an IP address, or you can configure a static IP address manually.

The following steps are based on Windows 10 operating system for your reference.

(Note: as remote access is disabled by default, you can't access to the router's Web GUI when you connect PC to GE 0 of the router. But it will function properly if you enable it on the Web GUI.)

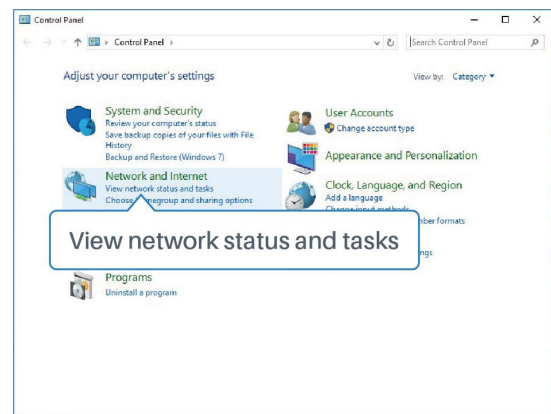
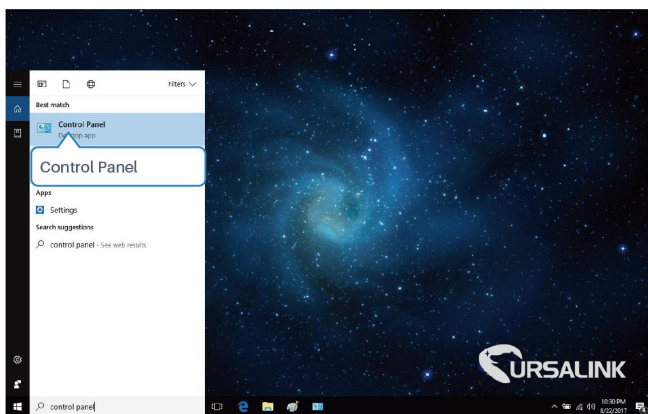

① Click "Search Box" to search "Control Panel" on the Windows 10 taskbar.

② Click "Control Panel" to open it, and then click "View network status and tasks".

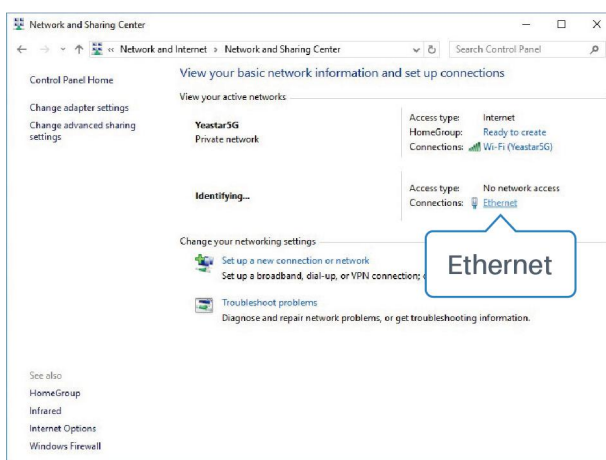

③ Click "Ethernet" (May have different name).

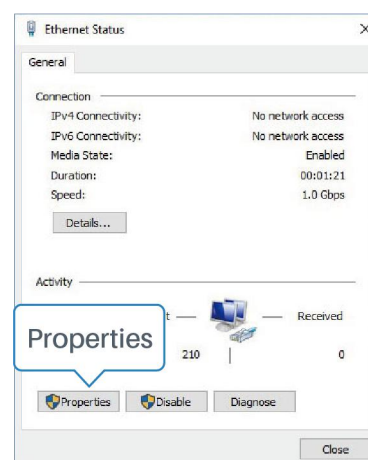

④ Click "Properties".

⑤ Double Click "Internet Protocol Version 4 (TCP/IPv4)" to configure IP address and DNS server.

⑥ Method 1: click "Obtain an IP address automatically";

Method 2: click "Use the following IP address" to assign a static IP manually within the same subnet of the router.

(Note: remember to click "OK" to finish configuration.)

3.2 Access to Web GUI of Router

Ursalink router provides Web-based configuration interface for management. If this is the first time you configure the router, please use the default settings below.

Username: admin

Password: password

IP Address: 192.168.1.1

DHCP Server: Enabled

1. Start a Web browser on your PC (Chrome and IE are recommended), type in the IP address, and press Enter on your keyboard.
2. Enter the username, password, and click "Login".

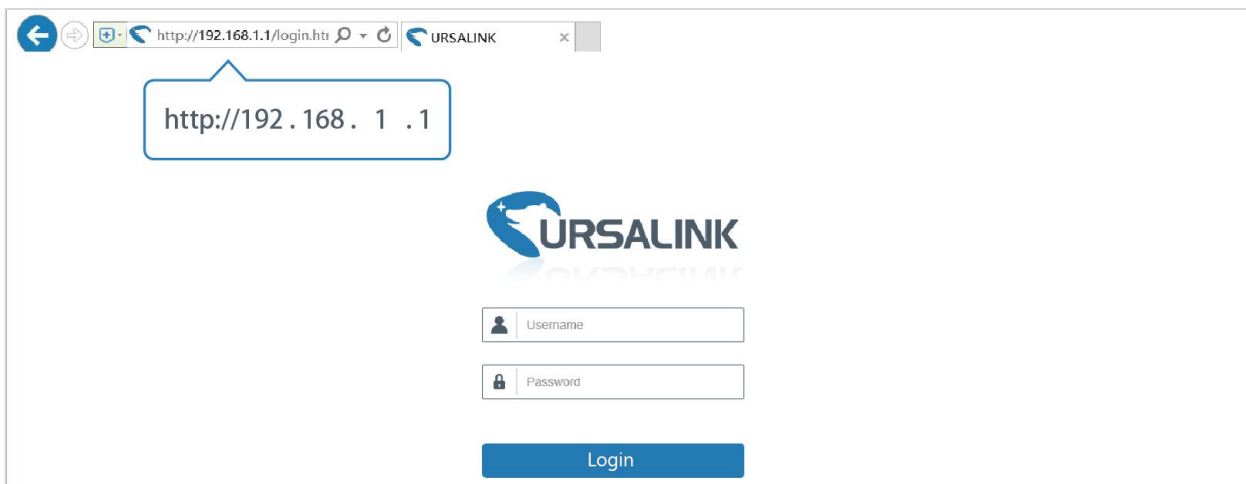

If the SIM card is connected to cellular network with public IP address, you can access WEB GUI remotely via the public IP address when remote access is enabled.

! If you enter the username or password incorrectly more than 5 times, the login page will be locked for 10 minutes.

3. When you login with the default username and password, you will be asked to modify the password. It's suggested that you change the password for the sake of security. Click "Cancel" button if you want to modify it later.

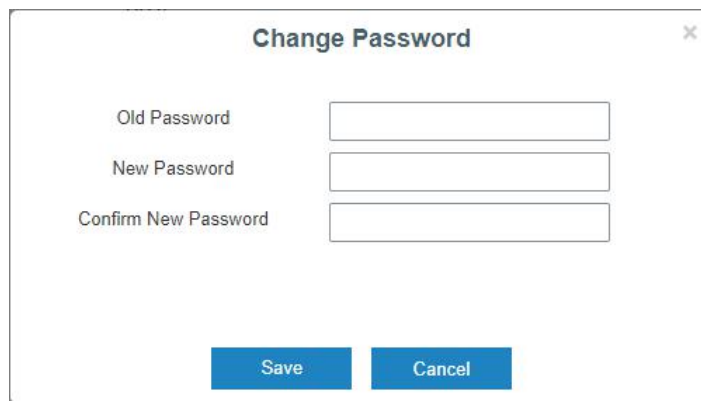

The image shows a 'Change Password' dialog box with three input fields: 'Old Password', 'New Password', and 'Confirm New Password'. Below the fields are two buttons: 'Save' and 'Cancel'.

4. After you login the Web GUI, you can view system information and perform configuration on the router.

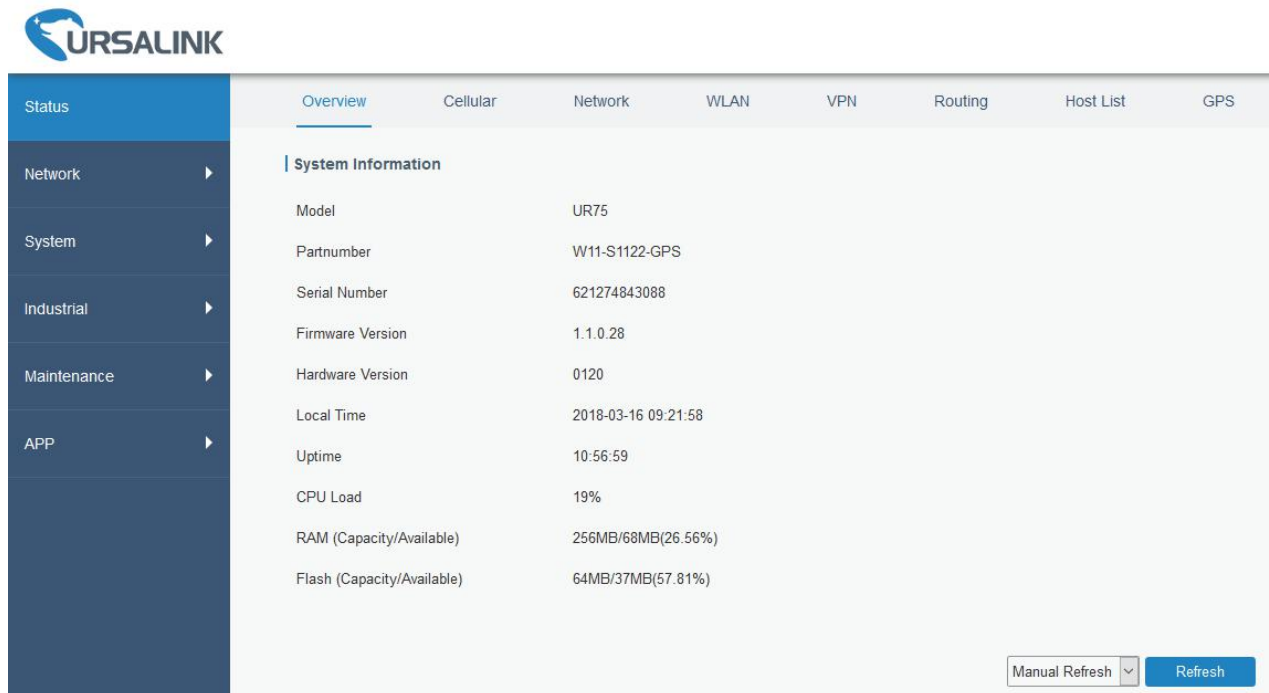

The image shows the URSA LINK Web GUI interface. The left sidebar contains navigation options: Status, Network, System, Industrial, Maintenance, and APP. The main content area is titled 'System Information' and displays the following data:

Parameter	Value
Model	UR75
Partnumber	W11-S1122-GPS
Serial Number	621274843088
Firmware Version	1.1.0.28
Hardware Version	0120
Local Time	2018-03-16 09:21:58
Uptime	10:56:59
CPU Load	19%
RAM (Capacity/Available)	256MB/68MB(26.56%)
Flash (Capacity/Available)	64MB/37MB(57.81%)

At the bottom right of the page, there is a 'Manual Refresh' dropdown menu and a 'Refresh' button.

Chapter 4 Web Configuration

4.1 Status

4.1.1 Overview

You can view the system information of the router on this page.

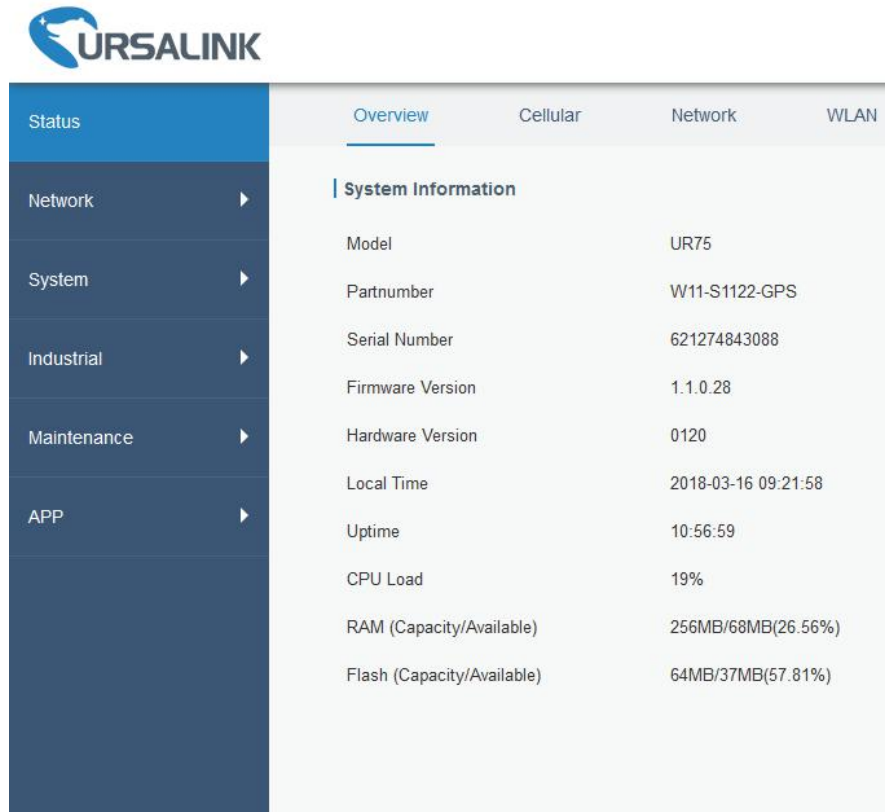

Figure 4-1-1-1

System Information	
Item	Description
Model	Show the model name of router.
Serial Number	Show the serial number of router.
Firmware Version	Show the currently firmware version of router.
Hardware Version	Show the currently hardware version of router.
Local Time	Show the currently local time of system.
Uptime	Show the information on how long the router has been running.
CPU Load	Show the current CPU utilization of the router.
RAM (Capacity/Available)	Show the RAM capacity and the available RAM memory.
Flash (Capacity/Available)	Show the Flash capacity and the available Flash memory.

Table 4-1-1-1 System Information

4.1.2 Cellular

You can view the cellular network status of router on this page.

Overview	Cellular	Network	VPN	Routing	Host List
Modem					
Status	Ready				
Model	EC25				
Current SIM	SIM1				
Signal Level	15asu (-83dBm)				
Register Status	Registered (Home network)				
IMSI	460019987103071				
ICCID	89860117838019196629				
ISP	CHN-UNICOM				
Network Type	LTE				
PLMN ID	46001				
LAC	5922				
Cell ID	812c63d				
IMEI	861107031710008				

Figure 4-1-2-1

Modem Information	
Item	Description
Status	Show corresponding detection status of module and SIM card.
Model	Show the model name of cellular module.
Current SIM	Show the current SIM card used.
Signal Level	Show the cellular signal level.
Register Status	Show the registration status of SIM card.
IMSI	Show IMSI of the SIM card.
ICCID	Show ICCID of the SIM card.
ISP	Show the network provider which the SIM card registers on.
Network Type	Show the connected network type, such as LTE, 3G, etc.
PLMN ID	Show the current PLMN ID, including MCC, MNC, LAC and Cell ID.
LAC	Show the location area code of the SIM card.
Cell ID	Show the Cell ID of the SIM card location.
IMEI	Show the IMEI of the module.

Table 4-1-2-1 Modem Information

Network	
Status	Connected
IP Address	10.53.241.18
Netmask	255.255.255.252
Gateway	10.53.241.17
DNS	218.104.128.106
Connection Duration	0 days, 00:04:26

Figure 4-1-2-2

Network Status	
Item	Description
Status	Show the connection status of cellular network.
IP Address	Show the IP address of cellular network.
Netmask	Show the netmask of cellular network.
Gateway	Show the gateway of cellular network.
DNS	Show the DNS of cellular network.
Connection Duration	Show information on how long the cellular network has been connected.

Table 4-1-2-2 Network Status

4.1.3 Network

On this page you can check the WAN and LAN status of the router.

Overview	Cellular	Network	VPN	Routing	Host List		
WAN							
Port	Status	Type	IP Address	Netmask	Gateway	DNS	Duration
GE 0	down	Static	192.168.0.1	255.255.255.0			00s

Figure 4-1-3-1

WAN Status	
Item	Description
Port	Show the name of WAN port.
Status	Show the status of WAN port. "up" refers to a status that WAN is enabled and Ethernet cable is connected. "down" means Ethernet cable is disconnected or WAN function is disabled.
Type	Show the dial-up connection type of WAN port.
IP Address	Show the IP address of WAN port.

Netmask	Show the netmask of WAN port.
Gateway	Show the gateway of WAN port.
DNS	Show the DNS of WAN port.
Connection Duration	Show the information on how long the Ethernet cable has been connected on WAN port when WAN function is enabled. Once WAN function is disabled or Ethernet connection is disconnected, the duration will stop.

Table 4-1-3-1 WAN Status

LAN				
Name	VLAN ID	IP Address	Netmask	MTU
GE1	-	192.168.1.1	255.255.255.0	1500

Figure 4-1-3-2

LAN Status	
Item	Description
Port	Show the name of LAN port.
VLAN ID	Show the label ID of the VLAN.
IP Address	Show the LAN port's IP address.
Netmask	Show the LAN port's netmask.
MTU	Show the maximum transmission unit of LAN port.

Table 4-1-3-2 LAN Status

4.1.4 WLAN (Only Applicable to Wi-Fi Version)

You can check Wi-Fi status on this page, including the information of access point and client.

Overview	Cellular	Network	WLAN	VPN	Routing	Host List
WLAN Status						
Wireless Status	Enabled					
MAC Address	24:e1:24:f0:00:f3					
Interface Type	AP					
SSID	test					
Channel	36					
Encryption Type	No Encryption					
Status	Up					
IP Address	192.168.232.1					
Netmask	255.255.255.0					
Connected Time	0 days, 01:37:48					

Figure 4-1-4-1

WLAN Status	
Item	Description
Wireless Status	Show the wireless status.
MAC Address	Show the MAC address.
Interface Type	Show the interface type, such as "AP" or "Client".
SSID	Show the SSID.
Channel	Show the wireless channel.
Authentication Type	Show the authentication type.
Encryption Type	Show the encryption type.
Status	Show the connection status.
IP Address	Show the IP address of the router.
Netmask	Show the wireless MAC address of the router.
Gateway	Show the gateway address in wireless network.
Connection Duration	Show information on how long the Wi-Fi network has been connected.

Table 4-1-4-1 WLAN Status

Associated Stations							
IP Address	MAC Address	Signal	RX Packets	Receive Rate	TX Packets	Send Rate	Connected Time

Figure 4-1-4-2

Associated Stations	
Item	Description
IP Address	Show the IP address of access point or client.
MAC Address	Show the MAC address of the access point or client.
Signal	Show the wireless signal.
RX Packets	Show the packets size of received data.
Receive Rate	Show the receive rate of data.
TX Packets	Show the packets size of transmitted data.
Send Rate	Show the send rate of data.
Connection Duration	Show information on how long the Wi-Fi network has been connected.

Table 4-1-4-2 WLAN Status

4.1.5 VPN

You can check VPN status on this page, including PPTP, L2TP, IPsec, OpenVPN and DMVPN.

Overview	Cellular	Network	<u>VPN</u>	Routing	Host List	GPS
PPTP Tunnel						
Name	Status	Local IP	Remote IP			
pptp_1	Disconnected	-	-			
pptp_2	Disconnected	-	-			
pptp_3	Disconnected	-	-			
L2TP Tunnel						
Name	Status	Local IP	Remote IP			
l2tp_1	Disconnected	-	-			
l2tp_2	Disconnected	-	-			
l2tp_3	Disconnected	-	-			

Figure 4-1-5-1

Overview	Cellular	Network	<u>VPN</u>	Routing	Host List	GPS
IPsec Tunnel						
Name	Status	Local IP	Remote IP			
ipsec_1	Disconnected	-	-			
ipsec_2	Disconnected	-	-			
ipsec_3	Disconnected	-	-			
OpenVPN Client						
Name	Status	Local IP	Remote IP			
openvpn_1	Disconnected	-	-			
openvpn_2	Disconnected	-	-			
openvpn_3	Disconnected	-	-			

Figure 4-1-5-2

GRE Tunnel				
Name	Status	Local IP	Remote IP	
gre_1	Disconnected	-	-	
gre_2	Disconnected	-	-	
gre_3	Disconnected	-	-	

DMVPN Tunnel				
Name	Status	Local IP	Remote IP	
dmvpn	Disconnected	-	-	

Figure 4-1-5-3

VPN Status	
Item	Description
Name	Show the name of the VPN tunnel.
Status	Show the status of the VPN tunnel.
Local IP	Show the local tunnel IP of VPN tunnel.
Remote IP	Show the remote tunnel IP of VPN tunnel.

Table 4-1-5-1 VPN Status

4.1.6 Routing Information

You can check routing status on this page, including the routing table and ARP cache.

Overview	Cellular	Network	VPN	Routing	Host List	GPS
Routing Table						
Destination	Netmask	Gateway	Interface	Metric		
0.0.0.0	0.0.0.0	192.168.23.1	GE0	1		
127.0.0.0	255.0.0.0	-	lo	-		
192.168.23.0	255.255.255.0	-	GE0	-		
ARP Cache						
IP	MAC	Interface				
192.168.23.58	00:00:00:00:00:00	GE0				
192.168.23.32	24:e1:24:f0:01:87	GE0				
192.168.23.1	24:e1:24:f0:01:97	GE0				

Figure 4-1-6-1

Item	Description
Routing Table	
Destination	Show the IP address of destination host or destination network.
Netmask	Show the netmask of destination host or destination network.
Gateway	Show the IP address of the gateway.
Interface	Show the outbound interface of the route.
Metric	Show the metric of the route.
ARP Cache	
IP	Show the IP address of ARP pool.
MAC	Show the IP address's corresponding MAC address.
Interface	Show the binding interface of ARP.

Table 4-1-6-1 Routing Information

4.1.7 Host List

You can view the host information on this page.

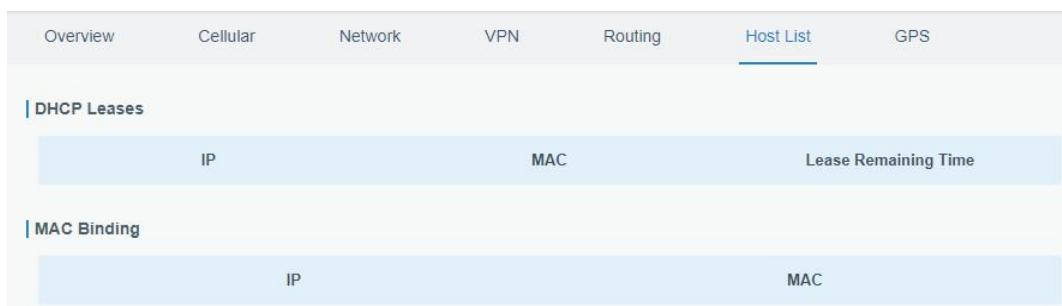

Figure 4-1-7-1

Host List	
Item	Description
DHCP Leases	
IP Address	Show IP address of DHCP client
MAC Address	Show MAC address of DHCP client
Lease Time Remaining	Show the remaining lease time of DHCP client.
MAC Binding	
IP & MAC	Show the IP address and MAC address set in the Static IP list of DHCP service.

Table 4-1-7-1 Host List Description

4.1.8 GPS

When GPS function is enabled and the GPS information is obtained successfully, you can view the latest GPS information including GPS Time, Latitude, Longitude and Speed on this page.

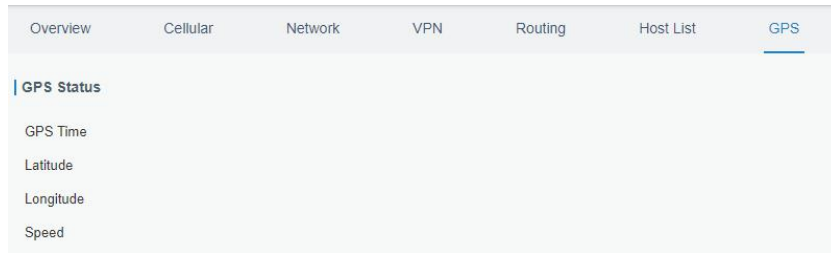

Figure 4-1-8-1

GPS Status	
Item	Description
Time for Locating	Show the time for locating.
Latitude	Show the Latitude of the location.
Longitude	Show the Longitude of the location.
Speed	Show the speed of movement.

Table 4-1-8-1 GPS Description

4.2 Network

4.2.1 Interface

4.2.1.1 Port

This section describes how to configure the Ethernet port parameters.

The UR75 industrial cellular router features 5 Gigabit Ethernet ports, named GE 0, GE 1/1, GE 1/2, GE 1/3 and GE 1/4. Among which, GE 0 is set as WAN port by default for accessing to public network and its property cannot be changed. While the rest from GE 1/1 to GE 1/4 are considered as LAN ports by default for connections with local private network. They can be defined as an additional WAN port, however, only one of them could be activated at one time.

Port	Definition	Default Definition	Default IP Address
GE 0	WAN	WAN	192.168.0.1
GE 1/1	LAN or WAN	LAN	192.168.1.1
GE 1/2	LAN or WAN	LAN	192.168.1.1
GE 1/3	LAN or WAN	LAN	192.168.1.1
GE 1/4	LAN or WAN	LAN	192.168.1.1

Table 4-2-1-2 Definition of 5 Ethernet Ports

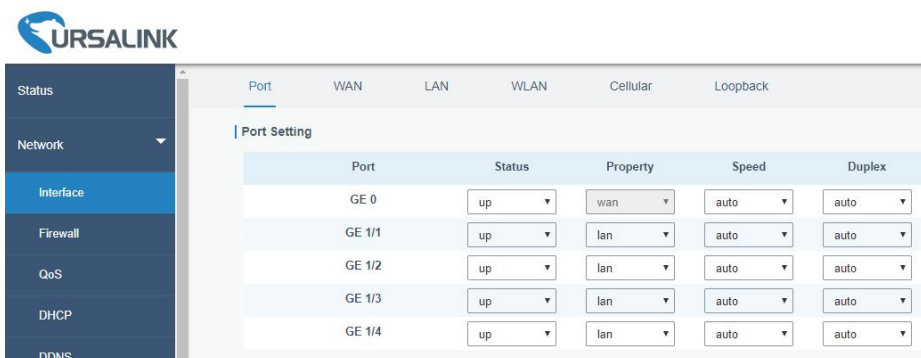

Figure 4-2-1-1

Port Setting	
Item	Description
Port	Users can define the Ethernet ports according to their needs.
Status	Set the status of Ethernet port; select "up" to enable and "down" to disable.
Property	UR75: Set the Ethernet port's type, as a WAN port or a LAN port.
Speed	Set the Ethernet port's speed. The options are "auto", "1000 Mbps", "100 Mbps", and "10 Mbps".
Duplex	Set the Ethernet port's mode. The options are "auto", "full", and "half".

Table 4-2-1-3 Port Parameters

4.2.1.2 WAN

WAN port can be connected with Ethernet cable to get Internet access. It supports 3 connection types.

- **Static IP:** configure IP address, netmask and gateway for Ethernet WAN interface.
- **DHCP Client:** configure Ethernet WAN interface as DHCP Client to obtain IP address automatically.
- **PPPoE:** configure Ethernet WAN interface as PPPoE Client.

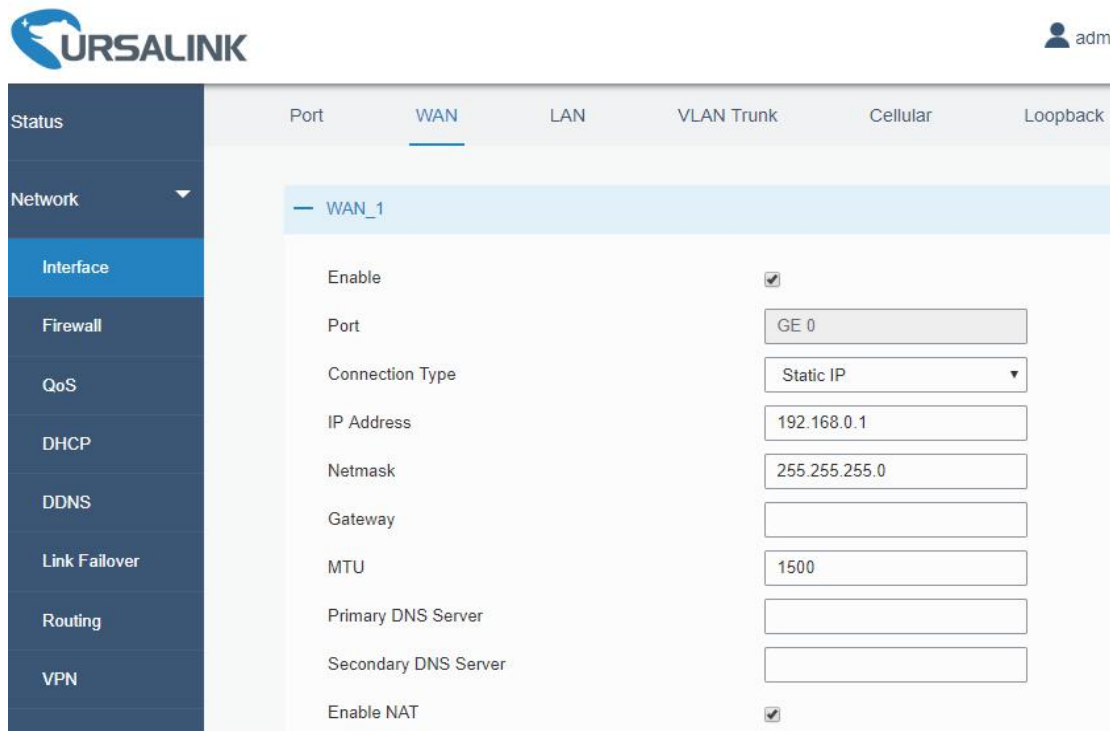

Figure 4-2-1-2

WAN Setting		
Item	Description	Default
Enable	Enable WAN function	Enable
Port	The port that is currently set as WAN port.	GE 0
Connection Type	Select from "Static IP", "DHCP Client" and "PPPoE".	Static IP
MTU	Set the maximum transmission unit.	1500
Primary DNS Server	Set the primary DNS.	Null

Secondary DNS Server	Set the secondary DNS.	Null
Enable NAT	Enable or disable NAT function. When enabled, a private IP can be translated to a public IP.	Enable

Table 4-2-1-4 WAN Parameters

1. Static IP Configuration

If the external network assigns a fixed IP for the WAN interface, user can select “Static IP” mode.

Figure 4-2-1-3

Static IP		
Item	Description	Default
IP Address	Set the IP address which can access Internet. E.g. 192.168.1.2.	192.168.0.1
Netmask	Set the Netmask for WAN port.	255.255.255.0
Gateway	Set the gateway's IP address for WAN port.	192.168.0.2
Multiple IP Address	Set the multiple IP addresses for WAN port.	Null

Table 4-2-1-5 Static Parameters

2. DHCP Client

If the external network has DHCP server enabled and has assigned IP addresses to the Ethernet WAN interface, user can select “DHCP client” mode to obtain IP address automatically.

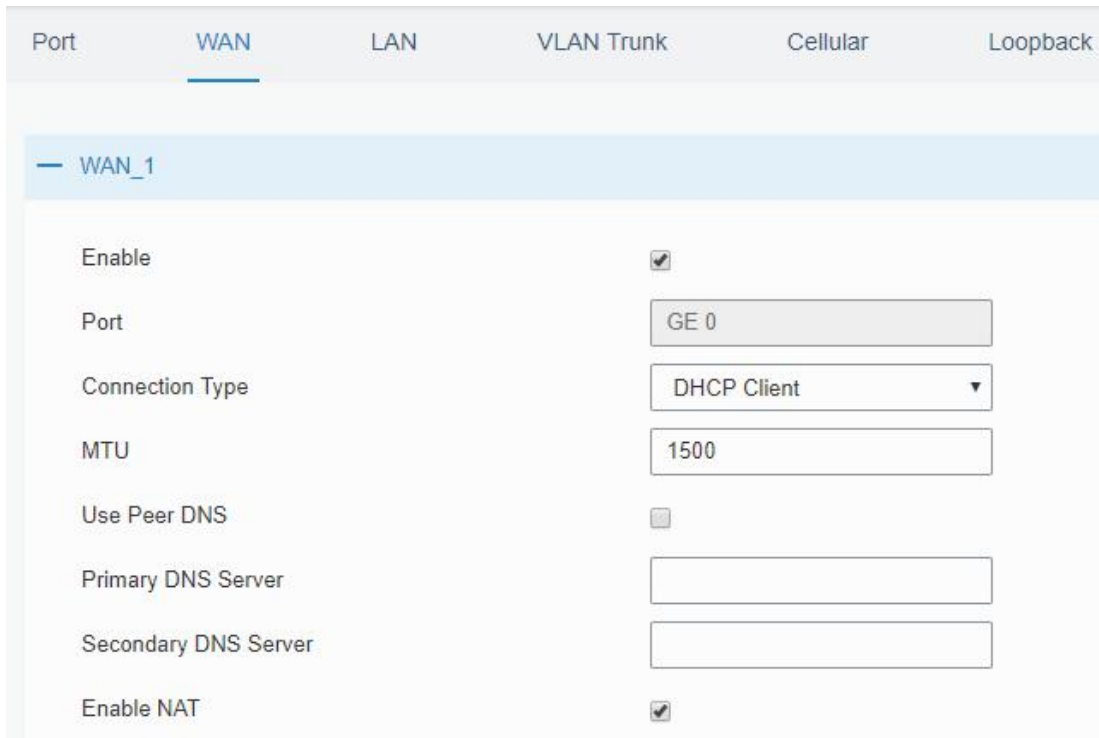

Port	WAN	LAN	VLAN Trunk	Cellular	Loopback
WAN_1					
Enable	<input checked="" type="checkbox"/>				
Port	GE 0				
Connection Type	DHCP Client				
MTU	1500				
Use Peer DNS	<input type="checkbox"/>				
Primary DNS Server					
Secondary DNS Server					
Enable NAT	<input checked="" type="checkbox"/>				

Figure 4-2-1-4

DHCP Client	
Item	Description
Use Peer DNS	Obtain peer DNS automatically during PPP dialing. DNS is necessary when visiting domain name.

Table 4-2-1-6 DHCP Client Parameter

3. PPPoE

PPPoE refers to a point to point protocol over Ethernet. User has to install a PPPoE client on the basis of original connection way. With PPPoE, remote access devices can get control of each user.

Port **WAN** LAN VLAN Trunk Cellular Loopback

— WAN_1

Enable

Port

Connection Type

Username

Password

Link Detection Interval(s)

Max Retries

MTU

Use Peer DNS

Primary DNS Server

Secondary DNS Server

Enable NAT

Figure 4-2-1-5

PPPoE	
Item	Description
Username	Enter the username provided by your Internet Service Provider (ISP).
Password	Enter the password provided by your Internet Service Provider (ISP).
Link Detection Interval (s)	Set the heartbeat interval for link detection. Range: 1-600.
Max Retries	Set the maximum retry times after it fails to dial up. Range: 0-9.
Use Peer DNS	Obtain peer DNS automatically during PPP dialing. DNS is necessary when visiting domain name.

Table 4-2-1-7 PPoE Parameters

Related Configuration Example

[Ethernet WAN Connection](#)

4.2.1.3 LAN

1. LAN Settings

LAN setting is used for managing local area network devices which are connected to LAN ports of the UR75, allowing each of them to access the Internet.

Click to delete the existing LAN port setting. Click to add a new LAN port.



Figure 4-2-1-6

LAN		
Item	Description	Default
Name	Set interface name of VLAN.	bridge0
VLAN ID	Select VLAN ID of the interface.	1
IP Address	Set IP address of LAN port.	192.168.1.1
Netmask	Set Netmask of LAN port.	255.255.255.0
MTU	Set the maximum transmission unit of LAN port. Range: 68-1500.	1500

Table 4-2-1-8 LAN Parameters

Related Configuration Example

[LAN Management](#)

2. VLAN Settings

VLAN is a kind of new data exchange technology that realizes virtual work groups by logically dividing the LAN device into network segments.

Click to delete the current VLAN setting. Click to add a new VLAN port.

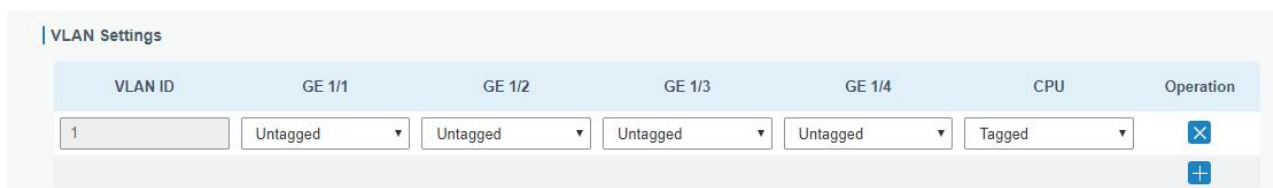

Figure 4-2-1-7

VLAN	
Item	Description
VLAN ID	Set the label ID of the VLAN. Range: 1-4094.
GE 1/1 - GE 1/4	Select status from "Tagged", "Untagged" and "Close" for Ethernet frame on trunk link.
CPU	Control communication between VLAN and other networks.

Table 4-2-1-9 VLAN Parameters

4.2.1.4 WLAN (Only Applicable to Wi-Fi Version)

This section explains how to set the related parameters for Wi-Fi network. UR75 supports 802.11 b/g/n/ac, as AP or client mode. Wi-Fi is optional on UR75.

Port	WAN	LAN	VLAN Trunk	WLAN	Cellular	Loopback
WLAN						
Enable		<input checked="" type="checkbox"/>				
Work Mode		AP				
SSID Broadcast		<input checked="" type="checkbox"/>				
AP Isolation		<input type="checkbox"/>				
Radio Type		802.11ac				
Channel		Auto				
SSID		test				
BSSID		24:e1:24:f0:00:f3				
Encryption Mode		No Encryption				
Bandwidth		80MHz				
Max Client Number		100				

Figure 4-2-1-10

IP Setting	
Protocol	Static IP
IP Address	192.168.232.1
Netmask	255.255.255.0

Figure 4-2-1-11

WLAN Settings	
Item	Description
Enable	Enable/disable WLAN.
Work Mode	Select router's work mode. The options are "Client" and "AP".
Scan	Click "Scan" button to search the nearby access point.
SSID	Show SSID.
Channel	Show wireless channel.
Signal	Show wireless signal.
BSSID	Show the MAC address of the access point.
Security	Show the encryption mode.
Frequency	Show the frequency of radio.
Join Network	Click the button to join the wireless network.
SSID	Fill in the SSID of the access point.
BSSID	Fill in the MAC address of the access point. Either SSID or BSSID can be filled to joint the network.
Encryption Mode	Select encryption mode. The options are "No Encryption", "WEP Open System", "WEP Shared Key", "WPA-PSK", "WPA2-PSK" and "WPA-PSK/WPA2-PSK".
Cipher	Select cipher. The options are "Auto", "AES", "TKIP" and "AES/TKIP".
Key	Fill the pre-shared key of WPA encryption.
Max Client Number	Set the maximum number of client to access when the router is configured as AP.
SSID Broadcast	When SSID broadcast is disabled, other wireless devices can't not find the SSID, and users have to enter the SSID manually to access to the wireless network.
AP Isolation	When AP isolation is enabled, all users which access to the AP are isolated without communication with each other.
Radio Type	Select Radio type. The options are "802.11b (2.4 GHz)", "802.11g (2.4 GHz)", "802.11n (2.4 GHz)", "802.11n (5 GHz)" and "802.11ac (5 GHz)".
Channel	Select wireless channel. The options are "Auto", "1", "2"....."13".
Bandwidth	Select bandwidth. The options are "20MHz" and "40MHz".
IP Setting	
Protocol	Set the IP address in wireless network.
IP Address	Set the IP address in wireless network.
Netmask	Set the netmask in wireless network.
Gateway	Set the gateway in wireless network.

Table 4-2-1-12 WLAN Parameters

Related Topic

[Wi-Fi Application Example](#)

4.2.1.5 Cellular

This section explains how to set the related parameters for cellular network. The UR75 cellular router has two cellular interfaces, namely SIM1 and SIM2. Only one cellular interface is active at one time. If both cellular interfaces are enabled, then SIM1 interface takes precedence by default.

A typical use case would be to have SIM1 configured as the primary cellular interface and SIM2 as a backup. If the UR75 cannot connect to the network via SIM1, it will automatically fail over to SIM2.

Port	WAN	LAN	VLAN Trunk	Cellular	Loopback
Cellular Setting					
		SIM1		SIM2	
Enable		<input checked="" type="checkbox"/>		<input type="checkbox"/>	
Network Type		Auto		Auto	
APN					
Username					
Password					
Access Number					
PIN Code					
Authentication Type		Auto		Auto	
Roaming		<input type="checkbox"/>		<input type="checkbox"/>	
SMS Center					

Figure 4-2-1-13

Connection Setting	<input type="checkbox"/>
Dual SIM Strategy	<input type="checkbox"/>
Enable NAT	<input checked="" type="checkbox"/>
ICMP Server	8.8.8.8
Secondary ICMP Server	114.114.114.114
PING Times	5
Packet Loss Rate	20 %
SMS Settings	
SMS Mode	PDU

Figure 4-2-1-14

General Settings		
Item	Description	Default
Enable	Check the option to enable the corresponding SIM card.	Enable
Network Type	Select from "Auto", "4G First", "4G Only", "3G First", "3G Only", "2G First", and "2G Only". Auto: connect to the network with the strongest signal automatically. 4G First: 4G network takes precedence. 4G Only: connect to 4G network only. And so on.	Auto
APN	Enter the Access Point Name for cellular dial-up connection provided by local ISP.	Null
Username	Enter the username for cellular dial-up connection provided by local ISP.	Null
Password	Enter the password for cellular dial-up connection provided by local ISP.	Null
Access Number	Enter the dial-up center NO. For cellular dial-up connection provided by local ISP.	Null
PIN Code	Enter a 4-8 characters PIN code to unlock the SIM.	Null
Authentication Type	Select from "Auto", "PAP", "CHAP", "MS-CHAP", and "MS-CHAPv2".	Auto
Roaming	Enable or disable roaming.	Disable
SMS Center	Enter the local SMS center number for storing, forwarding, converting and delivering SMS message.	Null
Enable NAT	Enable or disable NAT function.	Enable
ICMP Server	Set the ICMP detection server's IP address.	8.8.8.8
Secondary ICMP Server	Set the secondary ICMP detection server's IP address.	114.114.114.114
PING Times	Set PING packet numbers in each ICMP detection.	5
Packet Loss Rate	Set packet loss rate in each ICMP detection. ICMP detection fails when the preset packet loss rate is exceeded.	20

Table 4-2-1-13 Cellular Parameters

Connection Setting
 Connection Mode
 Redial Interval(s)
 Max Idle Time(s)
 Triggered by Call
 Triggered by SMS
 Triggered by IO
Dual SIM Strategy
 Primary SIM Card
 Switch to backup SIM card when ICMP detection fails
 Switch to backup SIM card when the connection fails
 Switch to backup SIM card when roaming is detected

Figure 4-2-1-15

Connection Mode	
Item	Description
Connection Mode	Select from "Always Online" and "Connect on Demand".
Connect on Demand	"Connect on Demand" includes "Triggered by Call", "Triggered by SMS", and "Triggered by IO".
Triggered by Call	The router will switch from offline mode to cellular network mode automatically when it receives a call from the specific phone number.
Call Group	Select a call group for call trigger. Go to "System > General > Phone" to set up phone group.
Triggered by SMS	The router will switch from offline mode to cellular network mode automatically when it receives a specific SMS from the specific mobile phone.
SMS Group	Select an SMS group for trigger. Go to "System > General > Phone" to set up SMS group.
SMS Text	Fill in the SMS content for triggering.
Triggered by IO	The router will switch from offline mode to cellular network mode automatically when the DI status is changed. Go to "Industrial > I/O > DI" to configure trigger condition.

Table 4-2-1-14 Cellular Parameters

Dual SIM Strategy	
Item	Description
Current SIM Card	Select between "SIM1" and "SIM2" as a current SIM card used.
Switch to backup SIM card when ICMP detection fails	The router will switch to the backup SIM card when packet loss rate in ICMP detection exceeds the preset value.
Switch to backup SIM card when the connection fails	The router will switch to the backup SIM card when the primary one fails to connect with cellular network.
Switch to backup SIM card when roaming is detected	The router will switch to the backup SIM card when the primary one is roaming.

Table 4-2-1-15 Cellular Parameters

Related Topics

- [Cellular Network Connection](#)
- [Dual SIM Failover Application Example](#)
- [WAN Failover Application Example](#)
- [Phone Group](#)
- [DI Setting](#)

4.2.1.7 Loopback

Loopback interface is used for replacing router's ID as long as it is activated. When the interface is DOWN, the ID of the router has to be selected again which leads to long convergence time of OSPF. Therefore, Loopback interface is generally recommended as the ID of the router.

Loopback interface is a logic and virtual interface on router. Under default conditions, there's no loopback interface on router, but it can be created as required.

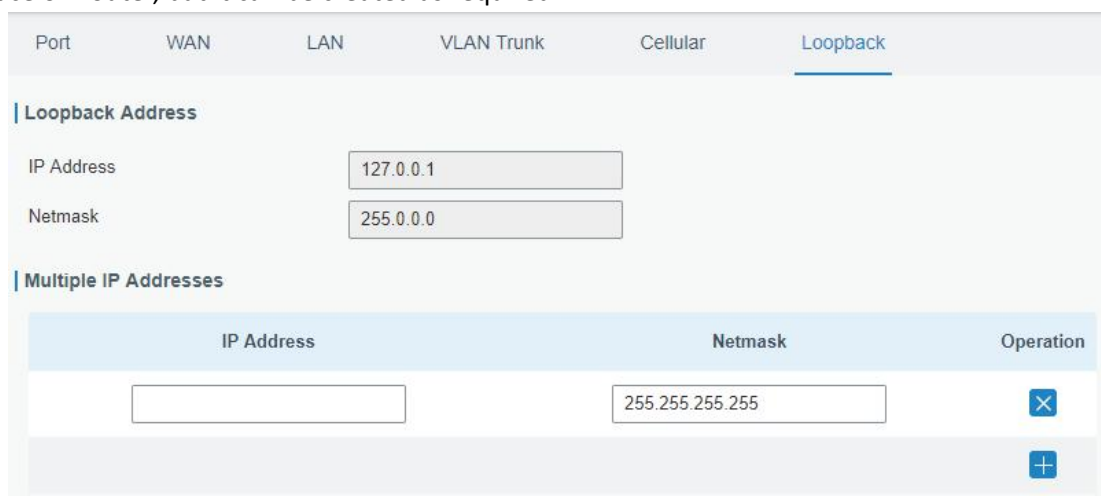

Figure 4-2-1-16

Loopback		
Item	Description	Default
IP Address	Unalterable	127.0.0.1
Netmask	Unalterable	255.0.0.0
Multiple IP Addresses	Apart from the IP above, user can configure other IP addresses.	Null

Table 4-2-1-16 Loopback Parameters

4.2.2 Firewall

This section describes how to set the firewall parameters, including ACL, DMZ, Port Mapping and MAC Binding.

The firewall implements corresponding control of data flow at entry direction (from Internet to local area network) and exit direction (from local area network to Internet) according to the content features of packets, such as protocol style, source/destination IP address, etc. It ensures that the router operate in a safe environment and host in local area network.

4.2.2.1 ACL

Access control list, also called ACL, implements permission or prohibition of access for specified network traffic (such as the source IP address) by configuring a series of matching rules so as to filter the network interface traffic. When router receives packet, the field will be analyzed according to the ACL rule applied to the current interface. After the special packet is identified, the permission or prohibition of corresponding packet will be implemented according to preset strategy.

The data package matching rules defined by ACL can also be used by other functions requiring flow distinction.

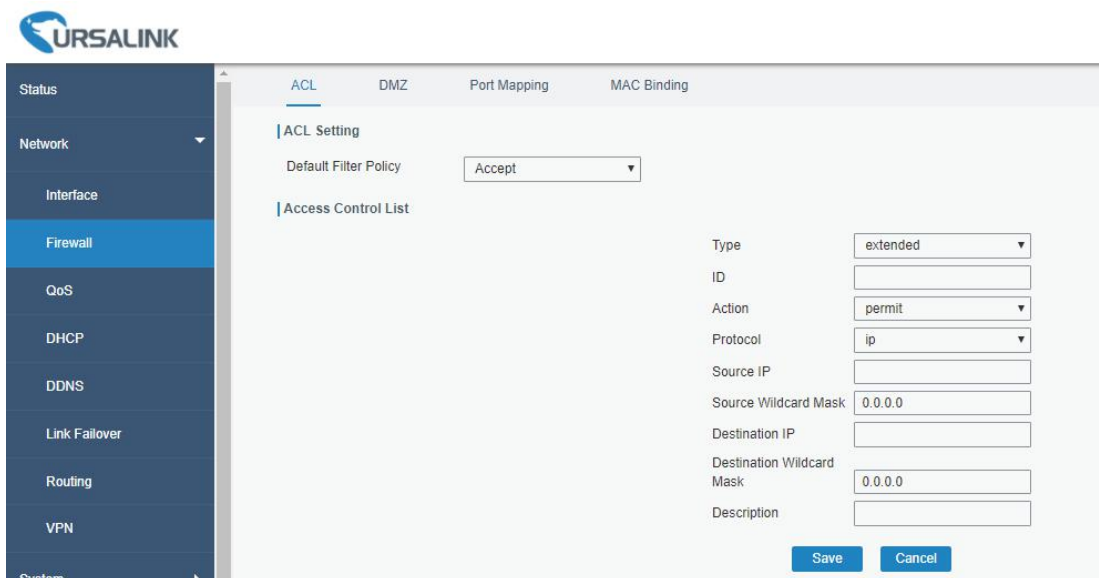

Figure 4-2-2-1

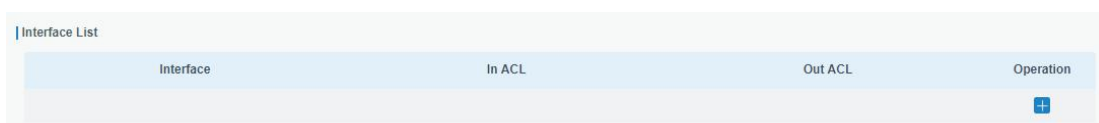

Figure 4-2-2-2

Item	Description
ACL Setting	
Default Filter Policy	Select from "Accept" and "Deny". The packets which are not included in the access control list will be processed by the default filter policy.
Access Control List	
Type	Select type from "Extended" and "Standard".
ID	User-defined ACL number. Range: 1-199.
Action	Select from "Permit" and "Deny".
Protocol	Select protocol from "ip", "icmp", "tcp", "udp", and "1-255".
Source IP	Source network address (leaving it blank means all).
Source Wildcard Mask	Wildcard mask of the source network address.
Destination IP	Destination network address (0.0.0.0 means all).
Destination Wildcard Mask	Wildcard mask of destination address.
Description	Fill in a description for the groups with the same ID.
ICMP Type	Enter the type of ICMP packet. Range: 0-255.
ICMP Code	Enter the code of ICMP packet. Range: 0-255.
Source Port Type	Select source port type, such as specified port, port range, etc.
Source Port	Set source port number. Range: 1-65535.
Start Source Port	Set start source port number. Range: 1-65535.
End Source Port	Set end source port number. Range: 1-65535.
Destination Port Type	Select destination port type, such as specified port, port range, etc.
Destination Port	Set destination port number. Range: 1-65535.
Start Destination Port	Set start destination port number. Range: 1-65535.
End Destination Port	Set end destination port number. Range: 1-65535.
More Details	Show information of the port.
Interface List	
Interface	Select network interface for access control.
In ACL	Select a rule for incoming traffic from ACL ID.
Out ACL	Select a rule for outgoing traffic from ACL ID.

Table 4-2-2-1 ACL Parameters

Related Configuration Example

[Access Control Application Example](#)

4.2.2.2 DMZ

DMZ is a host within the internal network that has all ports exposed, except those forwarded ports in port mapping.

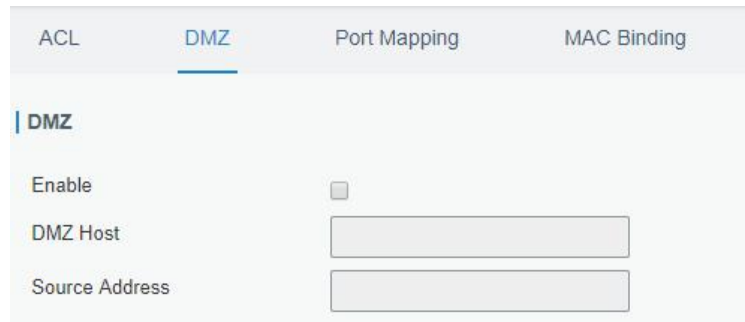

Figure 4-2-2-3

DMZ	
Item	Description
Enable	Enable or disable DMZ.
DMZ Host	Enter the IP address of the DMZ host on the internal network.
Source Address	Set the source IP address which can access to DMZ host. "0.0.0.0/0" means any address.

Table 4-2-2-2 DMZ Parameters

4.2.2.3 Port Mapping

Port mapping is an application of network address translation (NAT) that redirects a communication request from the combination of an address and port number to another while the packets are traversing a network gateway such as a router or firewall.

Click  to add a new port mapping rules.

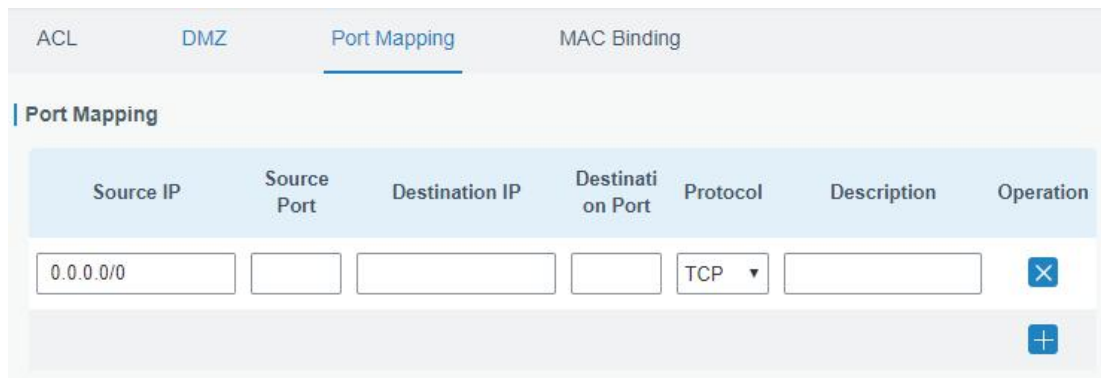

Figure 4-2-2-4

Port Mapping	
Item	Description
Source IP	Specify the host or network which can access local IP address. 0.0.0.0/0 means all.
Source Port	Enter the TCP or UDP port from which incoming packets are forwarded. Range: 1-65535.
Destination IP	Enter the IP address that packets are forwarded to after being received on the incoming interface.

Destination Port	Enter the TCP or UDP port that packets are forwarded to after being received on the incoming port(s). Range: 1-65535.
Protocol	Select from "TCP" and "UDP" as your application required.
Description	The description of this rule.

Table 4-2-2-3 Port Mapping Parameters

Related Configuration Example

[NAT Application Example](#)

4.2.2.4 MAC Binding

MAC Binding is used for specifying hosts by matching MAC addresses and IP addresses that are in the list of allowed outer network access.

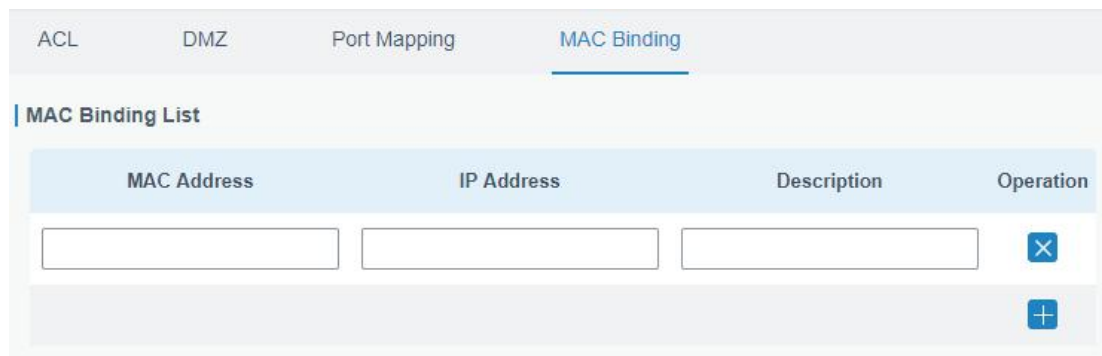

Figure 4-2-2-5

MAC Binding List	
Item	Description
MAC Address	Set the binding MAC address.
IP Address	Set the binding IP address.
Description	Fill in a description for convenience of recording the meaning of the binding rule for each piece of MAC-IP.

Table 4-2-2-4 MAC Binding Parameters

4.2.3 QoS

Quality of service (QoS) refers to traffic prioritization and resource reservation control mechanisms rather than the achieved service quality. QoS is engineered to provide different priority for different applications, users, data flows, or to guarantee a certain level of performance to a data flow.

4.2.3.1 QoS (Download/Upload)

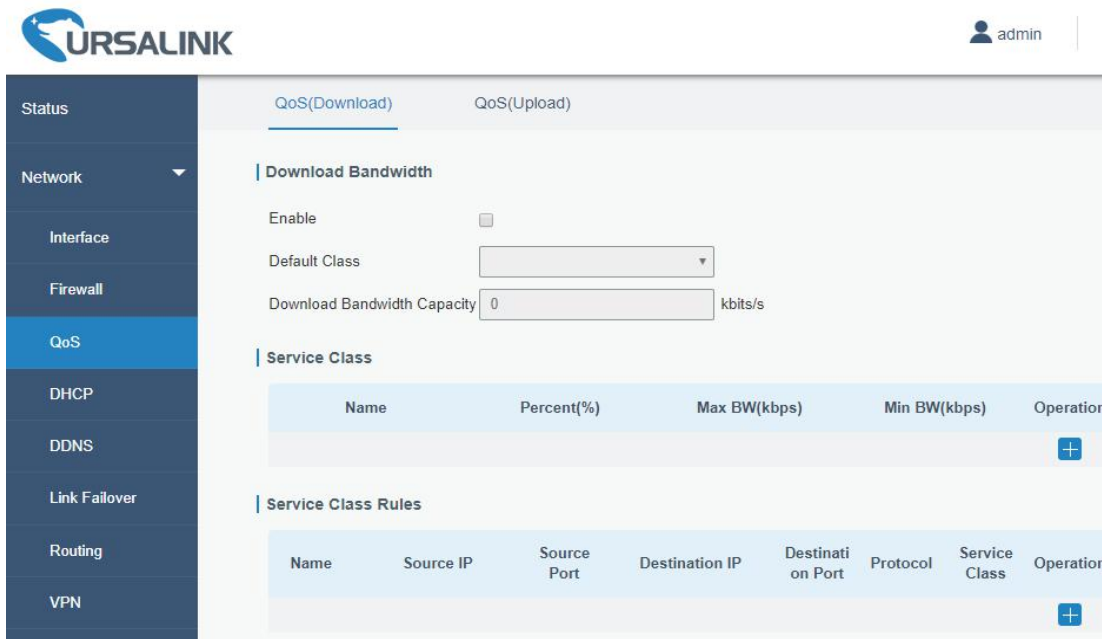

Figure 4-2-3-1

QoS	
Item	Description
Download/Upload	
Enable	Enable or disable QoS.
Default Class	Select default class from Service Class list.
Download/Upload Bandwidth Capacity	The download/upload bandwidth capacity of the network that the router is connected with, in kbps. Range: 1-8000000.
Service Classes	
Name	Give the service class a descriptive name.
Percent (%)	The amount of bandwidth that this class should be guaranteed in percentage. Range: 0-100.
Max BW(kbps)	The maximum bandwidth that this class is allowed to consume, in kbps. The value should be less than the "Download/Upload Bandwidth Capacity".
Min BW(kbps)	The minimum bandwidth that can be guaranteed for the class, in kbps. The value should be less than the "MAX BW" value.

Classification Rules	
Item	Description
Name	Give the rule a descriptive name.
Source IP	Source address of flow control (leaving it blank means any).

Source Port	Source port of flow control. Range: 0-65535 (leaving it blank means any).
Destination IP	Destination address of flow control (leaving it blank means any).
Destination Port	Destination port of flow control. Range: 0-65535 (leaving it blank means any).
Protocol	Select protocol from "ANY", "TCP", "UDP", "ICMP", and "GRE".
Service Class	Set service class for the rule.

Table 4-2-3-1 QoS (Download/Upload) Parameters

[Related Application Example](#)

[QoS Application Example](#)

4.2.4 DHCP

DHCP adopts Client/Server communication mode. The Client sends configuration request to the Server which feeds back corresponding configuration information and distributes IP address to the Client so as to achieve the dynamic configuration of IP address and other information.

4.2.4.1 DHCP Server

The UR75 can be set as a DHCP server to distribute IP address when a host logs on and ensures each host is supplied with different IP addresses. DHCP Server has simplified some previous network management tasks requiring manual operations to the largest extent.

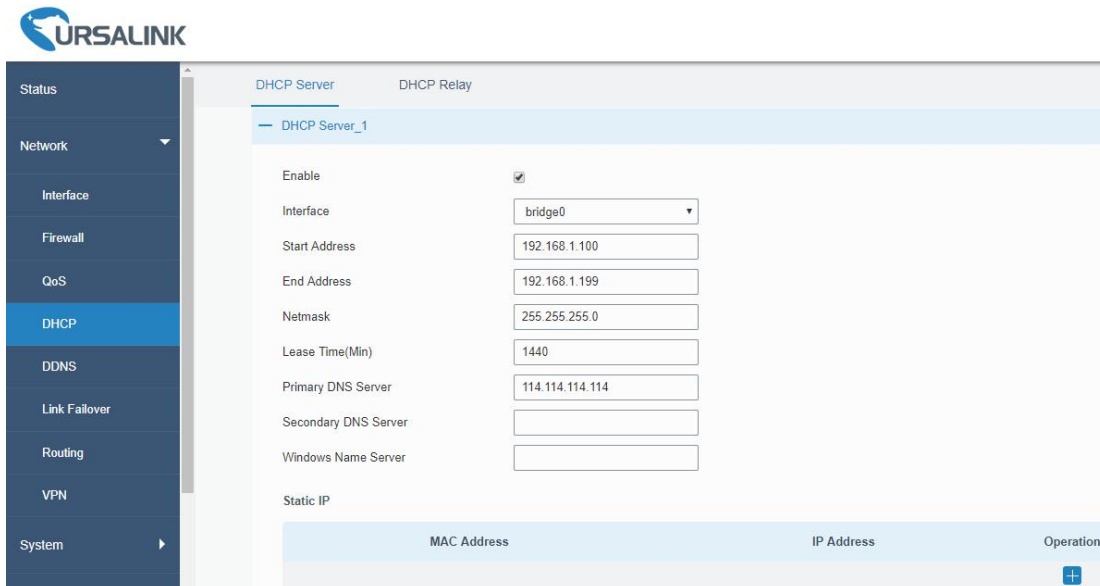

Figure 4-2-4-1

DHCP Server		
Item	Description	Default
Enable	Enable or disable DHCP server.	Enable

Interface	Select interface, e.g. GE1.	bridge0
Start Address	Define the beginning of the pool of IP addresses which will be leased to DHCP clients.	192.168.1.100
End Address	Define the end of the pool of IP addresses which will be leased to DHCP clients.	192.168.1.199
Netmask	Define the subnet mask of IP address obtained by DHCP clients from DHCP server.	255.255.255.0
Lease Time (Min)	Set the lease time on which the client can use the IP address obtained from DHCP server. Range: 1-10080.	1440
Primary DNS Server	Set the primary DNS server.	114.114.114.114
Secondary DNS Server	Set the secondary DNS server.	Null
Windows Name Server	Define the Windows Internet Naming Service obtained by DHCP clients from DHCP sever. Generally you can leave it blank.	Null
Static IP		
MAC Address	Set a static and specific MAC address for the DHCP client (it should be different from other MACs so as to avoid conflict).	Null
IP Address	Set a static and specific IP address for the DHCP client (it should be outside of the DHCP range).	Null

Table 4-2-4-1 DHCP Server Parameters

4.2.4.2 DHCP Relay

The UR75 can be set as DHCP Relay to provide a relay tunnel to solve the problem that DHCP Client and DHCP Server are not in the same subnet.



Figure 4-2-4-2

DHCP Relay	
Item	Description
Enable	Enable or disable DHCP relay.
DHCP Server	Set DHCP server, up to 10 servers can be configured; separate them by blank space or ",",

Table 4-2-4-2 DHCP Relay Parameters

4.2.5 DDNS

Dynamic DNS (DDNS) is a method that automatically updates a name server in the Domain Name System, which allows user to alias a dynamic IP address to a static domain name.

DDNS serves as a client tool and needs to coordinate with DDNS server. Before starting configuration, user shall register on a website of proper domain name provider and apply for a domain name.

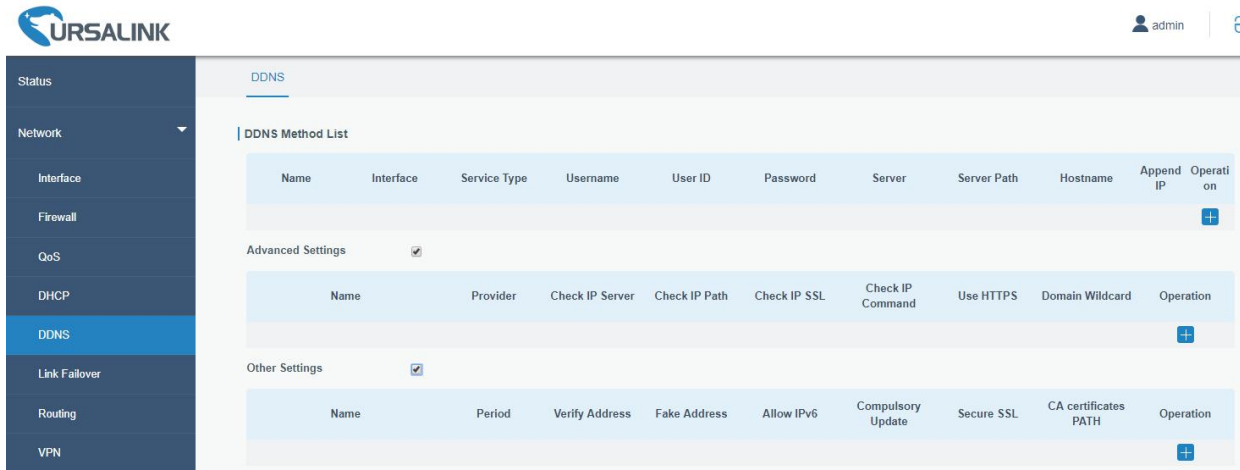

Figure 4-2-5-1

DDNS	
Item	Description
Name	Give the DDNS a descriptive name.
Interface	Set interface bundled with the DDNS.
Service Type	Select the DDNS service provider.
Username	Enter the username for DDNS register.
User ID	Enter User ID of the custom DDNS server.
Password	Enter the password for DDNS register.
Server	Enter the name of DDNS server.
Hostname	Enter the hostname for DDNS.
Append IP	Append your current IP to the DDNS server update path.

Table 4-2-5-1 DDNS Parameters

Item	Description
Advanced Options	
Name	Select the DDNS name.
Provider	Enter DDNS server provider.
Check IP Server	Server used for periodic IP address changes.
Check IP Path	Optional server path for check IP server.
Check IP SSL	This setting usually follows the SSL setting, but can be used to disable HTTPS for the IP address check. This might be needed for some providers that only support HTTPS for the DNS record update.
Check IP Command	Shell command, or script for IP address update checking.
Use HTTPS	Use HTTPS or not.

Domain Wildcard	Enable/disable domain name wildcard of your domain name.
Other Options	
Name	Select the DDNS name.
Period (s)	Decide how often is the IP address checked, in seconds. The default interval is 3600s. Range: 60-864000
Verify Address	Verify IP address, making sure the address is a valid Internet address.
Fake Address	This option can be used to fake an address by updating with a "random" address in the 203.0.113.0/24 range.
Allow IPv6	Allow or discard IPv6 addresses.
Forced Update (s)	Decide how often the IP should be updated even if it is not changed, in seconds. The default interval is 2592000 s (30 days).
Secure SSL	When this option is enabled, the DDNS update will be aborted before sending any credentials if the HTTPS certificate validation fails for a provider. When it's disabled, then will only a warning is issued.
CA Certificates PATH	Specify the path to a trusted set of CA certificates.

Table 4-2-5-2 DDNS Parameters

4.2.6 Link Failover

This section describes how to configure link failover strategies, including VRRP strategies and WAN failover strategies between Ethernet WAN and cellular.

Configuration Steps

1. Define one or more SLA operations (ICMP probe).
2. Define one or more track objects to track the status of SLA operation.
3. Define applications associated with track objects, such as VRRP, WAN failover or static routing.

4.2.6.1 SLA

SLA setting is used for configuring link probe method. The default probe type is ICMP.

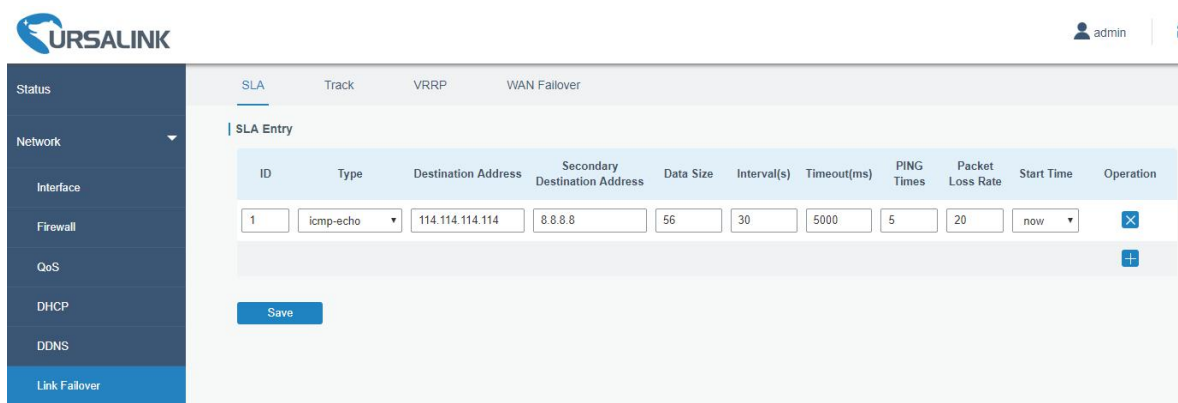

Figure 4-2-6-1

SLA		
Item	Description	Default
ID	SLA index. Up to 10 SLA settings can be added. Range: 1-10.	1
Type	ICMP-ECHO is the default type to detect if the link is alive.	icmp-echo
Destination Address	The detected IP address.	114.114.114.114
Secondary Destination Address	The secondary detected IP address.	8.8.8.8
Data Size	User-defined data size. Range: 0-1000.	56
Interval (s)	User-defined detection interval. Range: 1-608400.	30
Timeout (ms)	User-defined timeout for response to determine ICMP detection failure. Range: 1-300000.	5000
PING Times	Define PING packet numbers in each SLA probe. Range: 1-1000.	5
Packet Loss Rate	Define packet loss rate in each SLA probe. SLA probe fails when the preset packet loss rate is exceeded.	20
Start Time	Detection start time; select from "Now" and blank character. Blank character means this SLA detection doesn't start.	now

Table 4-2-6-1 SLA Parameters

4.2.6.2 Track

Track setting is designed for achieving linkage among SLA module, Track module and Application module. Track setting is located between application module and SLA module with main function of shielding the differences of various SLA modules and providing unified interfaces for application module.

Linkage between Track Module and SLA module

Once you complete the configuration, the linkage relationship between Track module and SLA module will be established. SLA module is used for detection of link status, network performance and notification of Track module. The detection results help track status change timely.

- For successful detection, the corresponding track item is Positive.
- For failed detection, the corresponding track item is Negative.

Linkage between Track Module and Application Module

After configuration, the linkage relationship between Track module and Application module will be established. When any change occurs in track item, a notification that requires corresponding treatment

will be sent to Application module.

Currently, the application modules like VRRP, WAN failover and static routing can get linkage with track module.

If it sends an instant notification to Application module, the communication may be interrupted in some circumstances due to routing's failure like timely restoration or other reasons. Therefore, user can set up a period of time to delay notifying application module when the track item status changes.

Figure 4-2-6-2

Item	Description	Default
Index	Track index. Up to 10 track settings can be configured. Range: 1-10.	1
Type	The options are "sla" and "interface".	SLA
SLA ID	Defined SLA ID.	1
Interface	Select the interface whose status will be detected.	cellular0
Negative Delay (s)	When interface is down or SLA probing fails, it will wait according to the time set here before actually changing its status to Down. Range: 0-180 (0 refers to immediate switching).	0
Positive Delay (s)	When failure recovery occurs, it will wait according to the time set here before actually changing its status to Up. Range: 0-180 (0 refers to immediate switching).	1

Table 4-2-6-2 Track Parameters

4.2.6.3 VRRP

The Virtual Router Redundancy Protocol (VRRP) is a computer networking protocol that provides automatic assignment of available Internet Protocol (IP) routers for participating hosts. This increases the availability and reliability of routing paths via automatic default gateway selections in an IP sub-network. Increasing the number of exit gateway is a common method for improving system reliability. VRRP adds a group of routers that undertake gateway function into a backup group so as to form a virtual router. The election mechanism of VRRP will decide which router undertakes the forwarding task, and the host in LAN is only required to configure the default gateway for the virtual router.

In VRRP, routers need to be aware of failures in the virtual master router. To achieve this, the virtual master router sends out multicast "alive" announcements to the virtual backup routers in the same VRRP

group.

The VRRP router who has the highest number will become the virtual master router. The VRRP router number ranges from 1 to 255 and usually we use 255 for the highest priority and 100 for backup.

If the current virtual master router receives an announcement from a group member (Router ID) with a higher priority, then the latter will pre-empt and become the virtual master router.

VRRP has the following characteristics:

- The virtual router with an IP address is known as the Virtual IP address. For the host in LAN, it is only required to know the IP address of virtual router, and set it as the address of the next hop of the default route.
- The network Host communicates with the external network through this virtual router.
- A router will be selected from the set of routers based on its priority to undertake the gateway function. Other routers will be used as backup routers to perform the duties of gateway for the gateway router in the case of any malfunction, so as to guarantee uninterrupted communication between the host and external network.

When interface connected with the uplink is at the state of Down or Removed, the router actively lowers its priority so that priority of other routers in the backup group will be higher. Thus the router with the highest priority becomes the gateway for the transmission task.

SLA	Track	VRRP	WAN Failover
VRRP Status			
Status	DISABLE		
VRRP Settings			
Enable	<input type="checkbox"/>		
Interface	GE0 ▼		
Virtual Router ID	<input type="text"/>		
Virtual IP	<input type="text"/>		
Priority	100		
Advertisement Interval(s)	1		
Preemption Mode	<input type="checkbox"/>		
Track ID	<input type="text"/>		

Figure 4-2-6-3

VRRP		
Item	Description	Default
Enable	Enable or disable VRRP.	Disable
Interface	Select the interface of Virtual Router.	None
Virtual Router ID	User-defined Virtual Router ID. Range: 1-255.	None
Virtual IP	Set the IP address of Virtual Router.	None
Priority	The VRRP priority range is 1-254 (a bigger number indicates a higher priority). The router with higher priority will be more likely to become the gateway router.	100
Advertisement Interval (s)	Heartbeat package transmission time interval between routers in the virtual ip group. Range: 1-255.	1
Preemption Mode	If the router works in the preemption mode, once it finds that its own priority is higher than that of the current gateway router, it will send VRRP notification package, resulting in re-election of gateway router and eventually replacing the original gateway router. Accordingly, the original gateway router will become a Backup router.	Disable
Track ID	Trace detection, select the defined track ID or blank character.	None

Table 4-2-6-3 VRRP Parameters

Note: for UR75, if you select “bridge0” as interface, you must select a track ID, otherwise VRRP status won’t show correctly.

Related Configuration Example

[VRRP Application Example](#)

4.2.6.4 WAN Failover

WAN failover refers to failover between Ethernet WAN interface and cellular interface. When service transmission can’t be carried out normally due to malfunction of a certain interface or lack of bandwidth, the rate of flow can be switched to backup interface quickly. Then the backup interface will carry out service transmission and share network flow so as to improve reliability of communication of data equipment.

When link state of main interface is switched from up to down, system will have the pre-set delay works instead of switching to link of backup interface immediately. Only if the state of main interface is still down after delay, will the system switch to link of backup interface. Otherwise, system will remain unchanged.

SLA	Track	VRRP	WAN Failover			
WAN Failover						
Main Interface	Backup Interface	Startup Delay(s)	Up Delay(s)	Down Delay(s)	Track ID	Operation
cellular0	GE0	3	0	0	1	✕
						+

Figure 4-2-6-4

WAN Failover		
Parameters	Description	Default
Main Interface	Select a link interface as the main link.	Cellular0
Backup Interface	Select a link interface as the backup link.	GE0
Startup Delay (s)	Set how long to wait for the startup tracking detection policy to take effect. Range: 0-300.	3
Up Delay (s)	When the primary interface switches from failed detection to successful detection, switching can be delayed based on the set time. Range: 0-180 (0 refers to immediate switching).	0
Down Delay (s)	When the primary interface switches from successful detection to failed detection, switching can be delayed based on the set time. Range: 0-180 (0 refers to immediate switching).	0
Track ID	Track detection, select the defined track ID.	1

Table 4-2-6-4 WAN Failover Parameters

Related Configuration Example

[WAN Failover Application Example](#)

4.2.7 Routing

4.2.7.1 Static Routing

A static routing is a manually configured routing entry. Information about the routing is manually entered rather than obtained from dynamic routing traffic. After setting static routing, the package for the specified destination will be forwarded to the path designated by user.

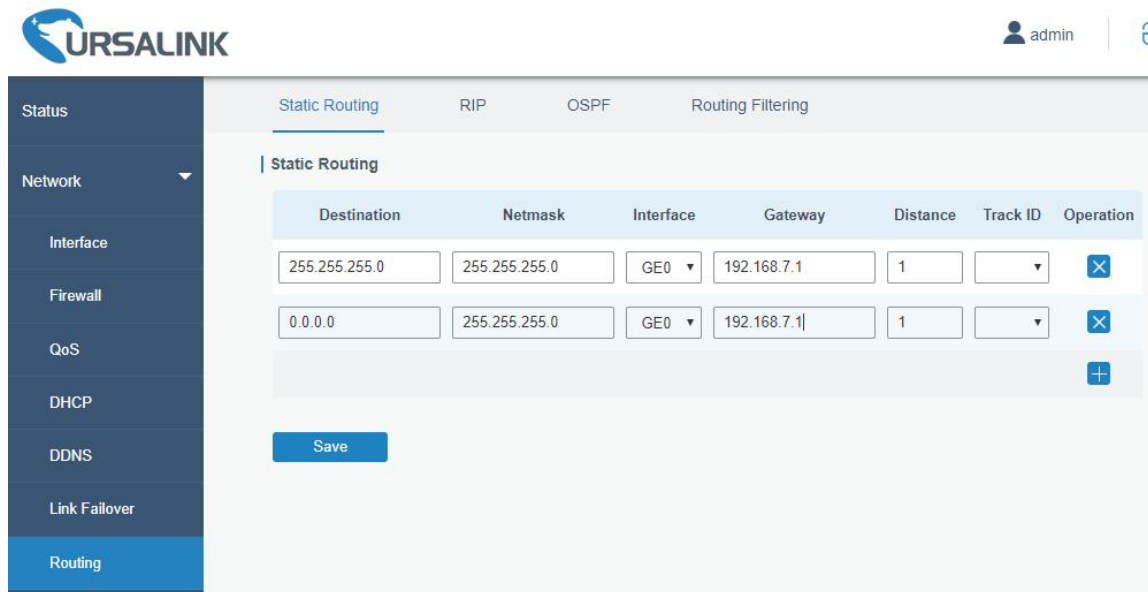

Figure 4-2-7-1

Static Routing	
Item	Description
Destination	Enter the destination IP address.
Netmask	Enter the subnet mask of destination address.
Interface	The interface through which the data can reach the destination address.
Gateway	IP address of the next router that will be passed by before the input data reaches the destination address.
Distance	Priority, smaller value refers to higher priority. Range: 1-255.
Track ID	Track detection, select the defined track ID. You can leave it blank.

Table 4-2-7-1 Static Routing Parameters

Related Topics

[Static Routing Application Example](#)

[Track Setting](#)

4.2.7.2 RIP

RIP is mainly designed for small networks. RIP uses Hop Count to measure the distance to the destination address, which is called Metric. In RIP, the hop count from the router to its directly connected network is 0 and the hop count of network to be reached through a router is 1 and so on. In order to limit the convergence time, the specified metric of RIP is an integer in the range of 0 - 15 and the hop count larger than or equal to 16 is defined as infinity, which means that the destination network or host is unreachable. Because of this limitation, the RIP is not suitable for large-scale networks. To improve performance and

prevent routing loops, RIP supports split horizon function. RIP also introduces routing obtained by other routing protocols.

Each router that runs RIP manages a routing database, which contains routing entries to reach all reachable destinations.

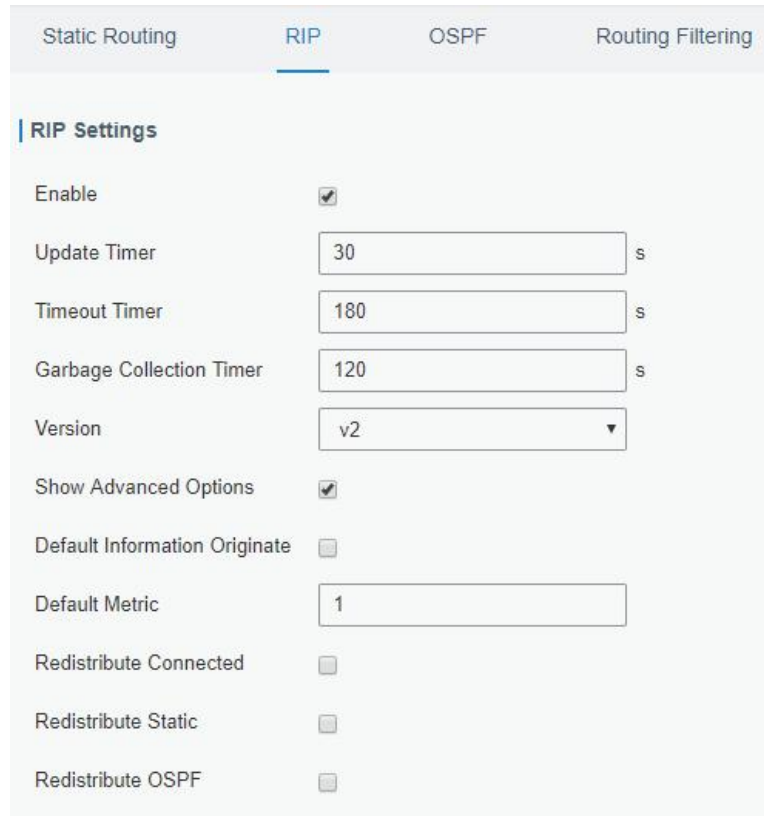

Figure 4-2-7-2

RIP	
Item	Description
Enable	Enable or disable RIP.
Update Timer	It defines the interval to send routing updates. Range: 5-2147483647, in seconds.
Timeout Timer	It defines the routing aging time. If no update package on a routing is received within the aging time, the routing's Routing Cost in the routing table will be set to 16. Range: 5-2147483647, in seconds.
Garbage Collection Timer	It defines the period from the routing cost of a routing becomes 16 to it is deleted from the routing table. In the time of Garbage-Collection, RIP uses 16 as the routing cost for sending routing updates. If Garbage Collection times out and the routing still has not been updated, the routing will be completely removed from the routing table. Range: 5-2147483647, in seconds.
Version	RIP version. The options are v1 and v2.
Advanced Settings	
Default Information Originate	Default information will be released when this function is enabled.

Default Metric	The default cost for the router to reach destination. Range: 0-16
Redistribute Connected	Check to enable.
Metric	Set metric after "Redistribute Connected" is enabled. Range: 0-16.
Redistribute Static	Check to enable.
Metric	Set metric after "Redistribute Static" is enabled. Range: 0-16.
Redistribute OSPF	Check to enable.
Metric	Set metric after "Redistribute OSPF" is enabled. Range: 0-16.

Table 4-2-7-2 RIP Parameters

Distance/Metric Management

Distance	IP Address	Netmask	ACL Name	Operation
				+

Metric	Policy In/Out	Interface	ACL Name	Operation
				+

Filter Policy

Policy Type	Policy Name	Policy In/Out	Interface	Operation
				+

Passive Interface

Passive Interface	Operation
	+

Interface

Interface	Send Version	Receive Version	Split-Horizon	Authentication Mode	Authentication String	Authentication Key-chain	Operation
							+

Neighbor

IP Address	Operation
	+

Network

IP Address	Netmask	Operation
		+

Figure 4-2-7-3

Item	Description
Distance/Metric Management	
Distance	Set the administrative distance that a RIP route learns. Range: 1-255.
IP Address	Set the IP address of RIP route.
Netmask	Set the netmask of RIP route.
ACL Name	Set ACL name of RIP route.
Metric	The metric of received route or sent route from the interface. Range: 0-16.
Policy in/out	Select from "in" and "out".
Interface	Select interface of the route.
ACL Name	Access control list name of the route strategy.
Filter Policy	
Policy Type	Select from "access-list" and "prefix-list".
Policy Name	User-defined prefix-list name.
Policy in/out	Select from "in" and "out".
Interface	Select interface from "cellular0", "GE1" and "GE0".
Passive Interface	
Passive Interface	Select interface from "cellular0" and "GE1", "GE0".
Interface	
Interface	Select interface from "cellular0", "GE1" and "GE0".
Send Version	Select from "default", "v1" and "v2".
Receive Version	Select from "default", "v1" and "v2".
Split-Horizon	Select from "enable" and "disable".
Authentication Mode	Select from "text" and "md5".
Authentication String	The authentication key for package interaction in RIPV2.
Authentication Key-chain	The authentication key-chain for package interaction in RIPV2.
Neighbor	
IP Address	Set RIP neighbor's IP address manually.
Network	
IP Address	The IP address of interface for RIP publishing.
Netmask	The netmask of interface for RIP publishing.

Table 4-2-7-3

Related Configuration Example

[Dynamic Routing Application Example](#)

4.2.7.3 OSPF

OSPF, short for Open Shortest Path First, is a link status based on interior gateway protocol developed by IETF.

If a router wants to run the OSPF protocol, there should be a Router ID that can be manually configured. If no Router ID configured, the system will automatically select an IP address of interface as the Router ID.

The selection order is as follows:

- If a Loopback interface address is configured, then the last configured IP address of Loopback interface will be used as the Router ID;
- If no Loopback interface address is configured, the system will choose the interface with the biggest IP address as the Router ID.

Five types of packets of OSPF:

- **Hello packet**
- **DD packet** (Database Description Packet)
- **LSR packet** (Link-State Request Packet)
- **LSU packet** (Link-State Update Packet)
- **LSAck packet** (Link-Sate Acknowledgment Packet)

Neighbor and Neighboring

After OSPF router starts up, it will send out Hello Packets through the OSPF interface. Upon receipt of Hello packet, OSPF router will check the parameters defined in the packet. If it's consistent, a neighbor relationship will be formed. Not all matched sides in neighbor relationship can form the adjacency relationship. It is determined by the network type. Only when both sides successfully exchange DD packets and LSDB synchronization is achieved, the adjacency in the true sense can be formed. LSA describes the network topology around a router, LSDB describes entire network topology.

Static Routing	RIP	OSPF	Routing Filtering
OSPF Settings			
Enable	<input type="checkbox"/>		
Router ID	<input type="text"/>		
ABR Type	<input type="text" value="cisco"/>		
RFC1583 Compatibility	<input checked="" type="checkbox"/>		
OSPF Opaque-LSA	<input type="checkbox"/>		
SPF Delay Time	<input type="text" value="0"/>	ms	
SPF Initial-holdtime	<input type="text" value="50"/>	ms	
SPF Max-holdtime	<input type="text" value="5000"/>	ms	
Reference Bandwidth	<input type="text" value="100"/>	mbit	

Figure 4-2-7-4

OSPF	
Item	Description
Enable	Enable or disable OSPF.
Router ID	Router ID (IP address) of the originating LSA.
ABR Type	Select from cisco, ibm, standard and shortcut.
RFC1583 Compatibility	Enable/Disable.
OSPF Opaque-LSA	Enable/Disable LSA: a basic communication means of the OSPF routing protocol for the Internet Protocol (IP).
SPF Delay Time	Set the delay time for OSPF SPF calculations. Range: 0-6000000, in milliseconds.
SPF Initial-holdtime	Set the initialization time of OSPF SPF. Range: 0-6000000, in milliseconds.
SPF Max-holdtime	Set the maximum time of OSPF SPF. Range: 0-6000000, in milliseconds.
Reference Bandwidth	Range: 1-4294967, in Mbit.

Table 4-2-7-4 OSPF Parameters

Interface

Interface	Hello Interval(s)	Dead Interval(s)	Retransmit Interval(s)	Transmit Delay(s)	Operation
<input type="text"/>	<input type="text" value="10"/>	<input type="text" value="40"/>	<input type="text" value="5"/>	<input type="text" value="1"/>	<input type="button" value="✕"/>
GE0	<input type="text" value="10"/>	<input type="text" value="40"/>	<input type="text" value="5"/>	<input type="text" value="1"/>	<input type="button" value="✕"/>
<input type="button" value="⊕"/>					

Interface Advanced Options

Interface	Network	Cost	Priority	Authentication	Key ID	Key	Operation
<input type="text"/>	<input type="text" value="broadcast"/>	<input type="text" value="10"/>	<input type="text" value="1"/>	<input type="text"/>	<input type="text"/>	<input type="text"/>	<input type="button" value="✕"/>
GE0	<input type="text" value="broadcast"/>	<input type="text" value="10"/>	<input type="text" value="1"/>	<input type="text"/>	<input type="text"/>	<input type="text"/>	<input type="button" value="✕"/>
<input type="button" value="⊕"/>							

Figure 4-2-7-5

Item	Description
Interface	
Interface	Select interface from "cellular0" and "GE0".
Hello Interval (s)	Send interval of Hello packet. If the Hello time between two adjacent routers is different, the neighbour relationship cannot be established. Range: 1-65535.
Dead Interval (s)	Dead Time. If no Hello packet is received from the neighbours within the dead time, then the neighbour is considered failed. If dead times of two adjacent routers are different, the neighbour relationship cannot be established.
Retransmit	When the router notifies an LSA to its neighbour, it is required to make

Interval (s)	acknowledgement. If no acknowledgement packet is received within the retransmission interval, this LSA will be retransmitted to the neighbour. Range: 3-65535.
Transmit Delay (s)	It will take time to transmit OSPF packets on the link. So a certain delay time should be increased before transmission the aging time of LSA. This configuration needs to be further considered on the low-speed link. Range: 1-65535
Interface Advanced Options	
Interface	Select interface.
Network	Select OSPF network type.
Cost	Set the cost of running OSPF on an interface. Range: 1-65535.
Priority	Set the OSPF priority of interface. Range: 0-255.
Authentication	Set the authentication mode that will be used by the OSPF area. Simple: a simple authentication password should be configured and confirmed again. MD5: MD5 key & password should be configured and confirmed again.
Key ID	It only takes effect when MD5 is selected. Range 1-255.
Key	The authentication key for OSPF packet interaction.

Table 4-2-7-5 OSPF Parameters

Passive Interface

Passive Interface		Operation
<input type="text"/>	<input type="text"/>	<input type="button" value="X"/>
		<input type="button" value="+"/>

Network

IP Address	Netmask	Area ID	Operation
<input type="text"/>	<input type="text" value="255.255.255.0"/>	<input type="text"/>	<input type="button" value="X"/>
			<input type="button" value="+"/>

Area

Area ID	Area	No Summary	Authentication	Operation
<input type="text"/>	<input type="text"/>	<input type="checkbox"/>	<input type="text"/>	<input type="button" value="X"/>
				<input type="button" value="+"/>

Figure 4-2-7-6

Item	Description
Passive Interface	
Passive Interface	Select interface from "cellular0", "GE0" and "GE1".

Network	
IP Address	The IP address of local network.
Netmask	The netmask of local network.
Area ID	The area ID of original LSA's router.
Area	
Area ID	Set the ID of the OSPF area (IP address).
Area	Select from "Stub" and "NSSA". The backbone area (area ID 0.0.0.0) cannot be set as "Stub" or "NSSA".
No Summary	Forbid route summarization.
Authentication	Select authentication from "simple" and "md5".

Table 4-2--7-6 OSPF Parameters

Area Advanced Options

Area Range

Area ID	IP Address	Netmask	No Advertise	Cost	Operation
					+

Area Filter

Area ID	Filter Type	ACL Name	Operation
			+

Area Virtual Link

Area ID	ABR Address	Authenticat ion	Key ID	Key	Hello Interval	Dead Interval	Retransmit Interval	Transmit Delay	Operation
									+

Figure 4-2-7-7

Area Advanced Options	
Item	Description
Area Range	
Area ID	The area ID of the interface when it runs OSPF (IP address).
IP Address	Set the IP address.
Netmask	Set the netmask.
No Advertise	Forbid the route information to be advertised among different areas.
Cost	Range: 0-16777215
Area Filter	
Area ID	Select an Area ID for Area Filter.
Filter Type	Select from "import", "export", "filter-in", and "filter-out".
ACL Name	Enter an ACL name which is set on "Routing > Routing Filtering" webpage.
Area Virtual Link	
Area ID	Set the ID number of OSPF area.
ABR Address	ABR is the router connected to multiple outer areas.

Authentication	Select from "simple" and "md5".
Key ID	It only takes effect when MD5 is selected. Range 1-15.
Key	The authentication key for OSPF packet interaction.
Hello Interval	Set the interval time for sending Hello packets through the interface. Range: 1-65535.
Dead Interval	The dead interval time for sending Hello packets through the interface. Range: 1-65535.
Retransmit Interval	The retransmission interval time for re-sending LSA. Range: 1-65535.
Transmit Delay	The delay time for LSA transmission. Range: 1-65535.

Table 4-2-7-7 OSPF Parameters

Figure 4-2-7-8

Item	Description
Redistribution	
Redistribution Type	Select from "connected", "static" and "rip".
Metric	The metric of redistribution router. Range: 0-16777214.
Metric Type	Select Metric type from "1" and "2".
Route Map	Mainly used to manage route for redistribution.
Redistribution Advanced Options	
Always Redistribute Default Route	Send redistribution default route after starting up.
Redistribute Default Route Metric	Send redistribution default route metric. Range: 0-16777214.
Redistribute Default Route Metric Type	Select from "0", "1" and "2".
Distance Management	
Area Type	Select from "intra-area", "inter-area" and "external".
Distance	Set the OSPF routing distance for area learning. Range: 1-255.

Table 4-2-7-8 OSPF Parameters

4.2.7.4 Routing Filtering

Figure 4-2-7-9

Routing Filtering	
Item	Description
Access Control List	
Name	User-defined name, need to start with a letter. Only letters, digits and underline () are allowed.
Action	Select from "permit" and "deny".
Match Any	No need to set IP address and subnet mask.
IP Address	User-defined.
Netmask	User-defined.
IP Prefix-List	
Name	User-defined name, need to start with a letter. Only letters, digits and underline () are allowed.
Sequence Number	A prefix name list can be matched with multiple rules. One rule is matched with one sequence number. Range: 1-4294967295.
Action	Select from "permit" and "deny".
Match Any	No need to set IP address, subnet mask, GE Length, and LE Length.
IP Address	User-defined.
Netmask	User-defined.
GE Length	Specify the minimum number of mask bits that must be matched. Range: 0-32.
LE Length	Specify the maximum number of mask bits that must be matched. Range: 0-32.

Table 4-2-7-9 Routing Filtering Parameters

4.2.8 VPN

Virtual Private Networks, also called VPNs, are used to securely connect two private networks together so that devices can connect from one network to the other network via secure channels.

UR75 supports DMVPN, IPsec, GRE, L2TP, PPTP, OpenVPN, as well as GRE over IPsec and L2TP over IPsec.

4.2.8.1 DMVPN

A dynamic multi-point virtual private network (DMVPN), combining mGRE and IPsec, is a secure network that exchanges data between sites without passing traffic through an organization's headquarter VPN server or router.

Figure 4-2-8-1

DMVPN	
Item	Description
Enable	Enable or disable DMVPN.
Hub Address	The IP address or domain name of DMVPN Hub.
Local IP address	DMVPN local tunnel IP address.
GRE Hub IP Address	GRE Hub tunnel IP address.

GRE Local IP Address	GRE local tunnel IP address.
GRE Netmask	GRE local tunnel netmask.
GRE Key	GRE tunnel key.
Negotiation Mode	Select from "Main" and "Aggressive".
Authentication Algorithm	Select from "DES", "3DES", "AES128", "AES192" and "AES256".
Encryption Algorithm	Select from "MD5" and "SHA1".
DH Group	Select from "MODP768_1", "MODP1024_2" and "MODP1536_5".
Key	Enter the preshared key.
Local ID Type	Select from "Default", "ID", "FQDN", and "User FQDN"
IKE Life Time (s)	Set the lifetime in IKE negotiation. Range: 60-86400.
SA Algorithm	Select from "DES_MD5", "DES_SHA1", "3DES_MD5", "3DES_SHA1", "AES128_MD5", "AES128_SHA1", "AES192_MD5", "AES192_SHA1", "AES256_MD5" and "AES256_SHA1".
PFS Group	Select from "NULL", "MODP768_1", "MODP1024_2" and "MODP1536-5".
Life Time (s)	Set the lifetime of IPsec SA. Range: 60-86400.
DPD Interval Time (s)	Set DPD interval time
DPD Timeout (s)	Set DPD timeout.
Cisco Secret	Cisco Nhrp key.
NHRP Holdtime (s)	The holdtime of Nhrp protocol.

Table 4-2-8-1 DMVPN Parameters

4.2.8.2 IPsec

IPsec is especially useful for implementing virtual private networks and for remote user access through dial-up connection to private networks. A big advantage of IPsec is that security arrangements can be handled without requiring changes to individual user computers.

IPsec provides three choices of security service: Authentication Header (AH), Encapsulating Security Payload (ESP), and Internet Key Exchange (IKE). AH essentially allows authentication of the senders' data. ESP supports both authentication of the sender and data encryption. IKE is used for cipher code exchange. All of them can protect one and more data flows between hosts, between host and gateway, and between gateways.

DMVPN
IPsec
GRE
L2TP
PPTP

| IPsec Settings

— IPsec_1

Enable	<input checked="" type="checkbox"/>
IPsec Gateway Address	<input type="text"/>
IPsec Mode	Tunnel ▼
IPsec Protocol	ESP ▼
Local Subnet	<input type="text"/>
Local Subnet Mask	<input type="text"/>
Local ID Type	Default ▼
Remote Subnet	<input type="text"/>
Remote Subnet Mask	<input type="text"/>
Remote ID Type	Default ▼

Figure 4-2-8-2

IPsec	
Item	Description
Enable	Enable IPsec tunnel. A maximum of 3 tunnels is allowed.
IPsec Gateway Address	Enter the IP address or domain name of remote IPsec server.
IPsec Mode	Select from "Tunnel" and "Transport".
IPsec Protocol	Select from "ESP" and "AH".
Local Subnet	Enter the local subnet IP address that IPsec protects.
Local Subnet Netmask	Enter the local netmask that IPsec protects.
Local ID Type	Select from "Default", "ID", "FQDN", and "User FQDN".
Remote Subnet	Enter the remote subnet IP address that IPsec protects.
Remote Subnet Mask	Enter the remote netmask that IPsec protects.
Remote ID type	Select from "Default", "ID", "FQDN", and "User FQDN".

Table 4-2-8-2 IPsec Parameters

IKE Parameter	<input checked="" type="checkbox"/>
IKE Version	IKEv1
Negotiation Mode	Main
Encryption Algorithm	DES
Authentication Algorithm	MD5
DH Group	MODP768-1
Local Authentication	PSK
Local Secrets	
XAUTH	<input type="checkbox"/>
Lifetime(s)	10800
SA Parameter	<input checked="" type="checkbox"/>
SA Algorithm	DES-MD5
PFS Group	NULL
Lifetime(s)	3600
DPD Time Interval(s)	30
DPD Timeout(s)	150
IPsec Advanced	<input checked="" type="checkbox"/>
Enable Compression	<input type="checkbox"/>
VPN Over IPsec Type	NONE

Figure 4-2-8-3

IKE Parameter	
Item	Description
IKE Version	Select from "IKEv1" and "IKEv2".
Negotiation Mode	Select from "Main" and "Aggressive".
Encryption Algorithm	Select from "DES", "3DES", "AES128", "AES192" and "AES256".
Authentication Algorithm	Select from "MD5" and "SHA1"
DH Group	Select from "MODP768_1", "MODP1024_2" and "MODP1536_5".
Local Authentication	Select from "PSK" and "CA".
Local Secrets	Enter the pre-shared key.
XAUTH	Enter XAUTH username and password after XAUTH is enabled.
Lifetime (s)	Set the lifetime in IKE negotiation. Range: 60-86400.
SA Parameter	

SA Algorithm	Select from "DES_MD5", "DES_SHA1", "3DES_MD5", "3DES_SHA1", "AES128_MD5", "AES128_SHA1", "AES192_MD5", "AES192_SHA1", "AES256_MD5" and "AES256_SHA1".
PFS Group	Select from "NULL", "MODP768_1", "MODP1024_2" and "MODP1536_5".
Lifetime (s)	Set the lifetime of IPsec SA. Range: 60-86400.
DPD Interval Time(s)	Set DPD interval time to detect if the remote side fails.
DPD Timeout(s)	Set DPD timeout. Range: 10-3600.
IPsec Advanced	
Enable Compression	The head of IP packet will be compressed after it's enabled.
VPN Over IPsec Type	Select from "NONE", "GRE" and "L2TP" to enable VPN over IPsec function.

Table 4-2-8-3 IPsec Parameters

4.2.8.3 GRE

Generic Routing Encapsulation (GRE) is a protocol that encapsulates packets in order to route other protocols over IP networks. It's a tunneling technology that provides a channel through which encapsulated data message could be transmitted and encapsulation and decapsulation could be realized at both ends.

In the following circumstances the GRE tunnel transmission can be applied:

- GRE tunnel could transmit multicast data packets as if it were a true network interface. Single use of IPsec cannot achieve the encryption of multicast.
- A certain protocol adopted cannot be routed.
- A network of different IP addresses shall be required to connect other two similar networks.

DMVPN
IPsec
GRE
L2TP
PPTP

GRE Settings

— GRE_1

Enable	<input checked="" type="checkbox"/>
Remote IP Address	<input type="text"/>
Local IP Address	<input type="text"/>
Local Virtual IP Address	<input type="text"/>
Netmask	<input type="text" value="255.255.255.0"/>
Peer Virtual IP Address	<input type="text"/>
Global Traffic Forwarding	<input type="checkbox"/>
Remote Subnet	<input type="text"/>
Remote Netmask	<input type="text"/>
MTU	<input type="text" value="1500"/>
Key	<input type="text"/>
Enable NAT	<input checked="" type="checkbox"/>

Figure 4-2-8-4

GRE	
Item	Description
Enable	Check to enable GRE function.
Remote IP Address	Enter the real remote IP address of GRE tunnel.
Local IP Address	Set the local IP address.
Local Virtual IP Address	Set the local tunnel IP address of GRE tunnel.
Netmask	Set the local netmask.
Peer Virtual IP Address	Enter remote tunnel IP address of GRE tunnel.
Global Traffic Forwarding	All the data traffic will be sent out via GRE tunnel when this function is enabled.
Remote Subnet	Enter the remote subnet IP address of GRE tunnel.
Remote Netmask	Enter the remote netmask of GRE tunnel.
MTU	Enter the maximum transmission unit. Range: 64-1500.
Key	Set GRE tunnel key.
Enable NAT	Enable NAT traversal function.

Table 4-2-8-4 GRE Parameters

4.2.8.4 L2TP

Layer Two Tunneling Protocol (L2TP) is an extension of the Point-to-Point Tunneling Protocol (PPTP) used

by an Internet service provider (ISP) to enable the operation of a virtual private network (VPN) over the Internet.

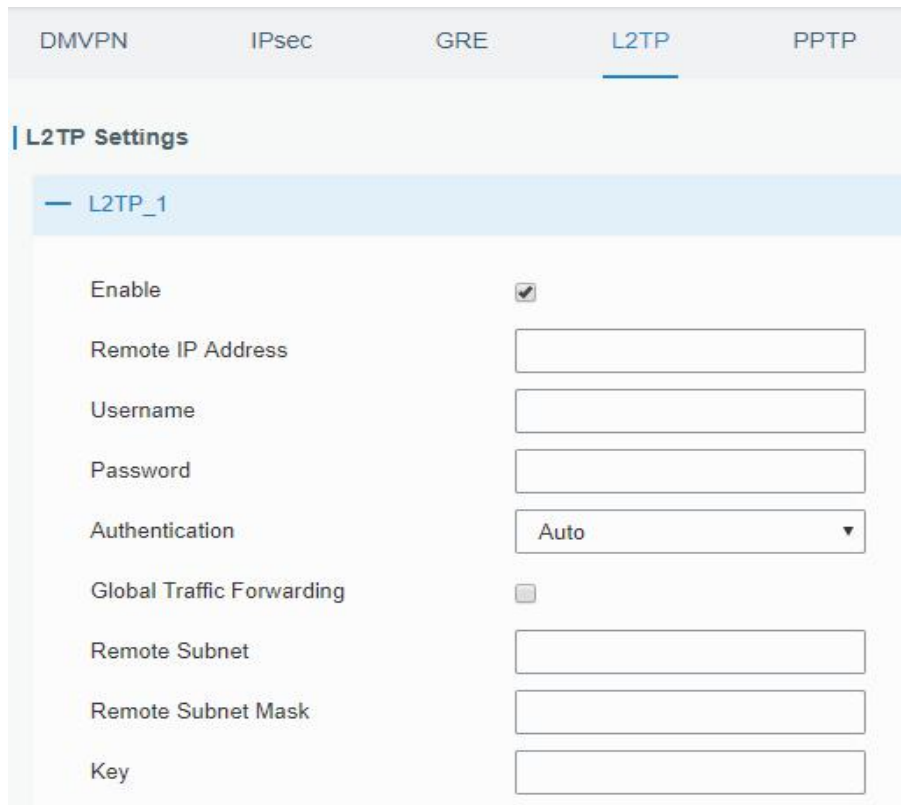

Figure 4-2-8-5

L2TP	
Item	Description
Enable	Check to enable L2TP function.
Remote IP Address	Enter the public IP address or domain name of L2TP server.
Username	Enter the username that L2TP server provides.
Password	Enter the password that L2TP server provides.
Authentication	Select from "Auto", "PAP", "CHAP", "MS-CHAPv1" and "MS-CHAPv2".
Global Traffic Forwarding	All of the data traffic will be sent out via L2TP tunnel after this function is enabled.
Remote Subnet	Enter the remote IP address that L2TP protects.
Remote Subnet Mask	Enter the remote netmask that L2TP protects.
Key	Enter the password of L2TP tunnel.

Table 4-2-8-5 L2TP Parameters

Advanced Settings	<input checked="" type="checkbox"/>
Local IP Address	<input type="text"/>
Peer IP Address	<input type="text"/>
Enable NAT	<input checked="" type="checkbox"/>
Enable MPPE	<input checked="" type="checkbox"/>
Address/Control Compression	<input type="checkbox"/>
Protocol Field Compression	<input type="checkbox"/>
Asyncmap Value	<input type="text" value="ffffff"/>
MRU	<input type="text" value="1500"/>
MTU	<input type="text" value="1500"/>
Link Detection Interval(s)	<input type="text" value="60"/>
Max Retries	<input type="text" value="0"/>
Expert Options	<input type="text"/>

Figure 4-2-8-6

Advanced Settings	
Item	Description
Local IP Address	Set tunnel IP address of L2TP client. Client will obtain tunnel IP address automatically from the server when it's null.
Peer IP Address	Enter tunnel IP address of L2TP server.
Enable NAT	Enable NAT traversal function.
Enable MPPE	Enable MPPE encryption.
Address/Control Compression	For PPP initialization. User can keep the default option.
Protocol Field Compression	For PPP initialization. User can keep the default option.
Asyncmap Value	One of the PPP protocol initialization strings. User can keep the default value. Range: 0-ffffff.
MRU	Set the maximum receive unit. Range: 64-1500.
MTU	Set the maximum transmission unit. Range: 64-1500
Link Detection Interval (s)	Set the link detection interval time to ensure tunnel connection. Range: 0-600.
Max Retries	Set the maximum times of retry to detect the L2TP connection failure. Range: 0-10.
Expert Options	User can enter some other PPP initialization strings in this field and separate the strings with blank space.

Table 4-2-8-6 L2TP Parameters

4.2.8.5 PPTP

Point-to-Point Tunneling Protocol (PPTP) is a protocol that allows corporations to extend their own corporate network through private "tunnels" over the public Internet. Effectively, a corporation uses a wide-area network as a single large local area network.

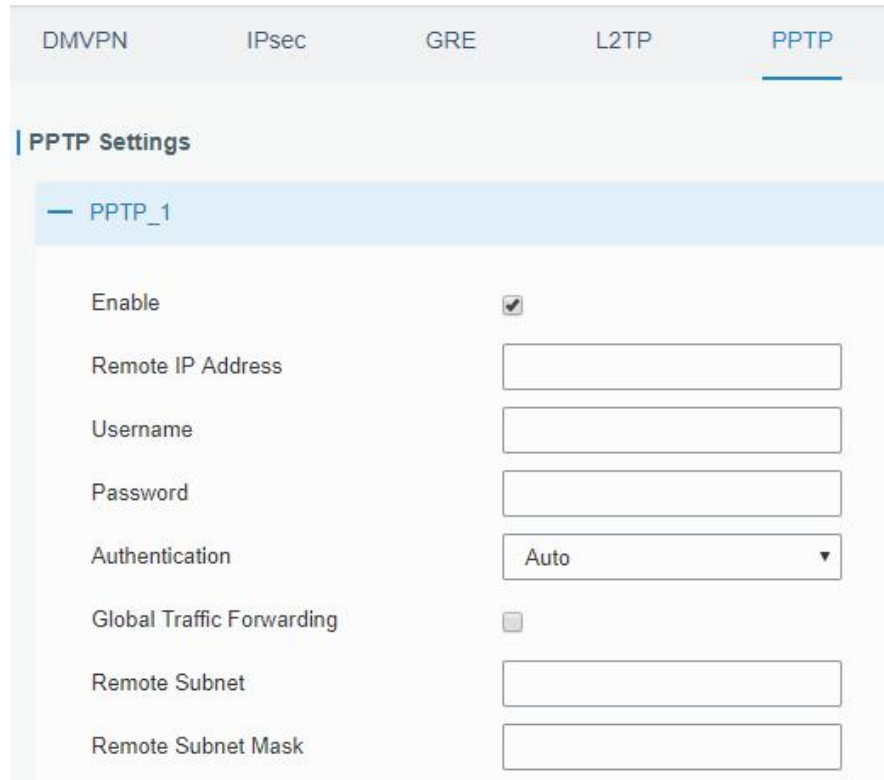

The screenshot shows a configuration interface for PPTP. At the top, there are tabs for DMVPN, IPsec, GRE, L2TP, and PPTP, with PPTP selected. Below the tabs is a section titled 'PPTP Settings'. Underneath, there is a sub-section for 'PPTP_1'. The settings include:

- Enable:** A checkbox that is checked.
- Remote IP Address:** An empty text input field.
- Username:** An empty text input field.
- Password:** An empty text input field.
- Authentication:** A dropdown menu currently set to 'Auto'.
- Global Traffic Forwarding:** An unchecked checkbox.
- Remote Subnet:** An empty text input field.
- Remote Subnet Mask:** An empty text input field.

Figure 4-2-8-7

PPTP	
Item	Description
Enable	Enable PPTP client. A maximum of 3 tunnels is allowed.
Remote IP Address	Enter the public IP address or domain name of PPTP server.
Username	Enter the username that PPTP server provides.
Password	Enter the password that PPTP server provides.
Authentication	Select from "Auto", "PAP", "CHAP", "MS-CHAPv1", and "MS-CHAPv2".
Global Traffic Forwarding	All of the data traffic will be sent out via PPTP tunnel once enable this function.
Remote Subnet	Set the peer subnet of PPTP.
Remote Subnet Mask	Set the netmask of peer PPTP server.

Table 4-2-8-7 PPTP Parameters

Advanced Settings	<input checked="" type="checkbox"/>
Local IP Address	<input type="text"/>
Peer IP Address	<input type="text"/>
Enable NAT	<input checked="" type="checkbox"/>
Enable MPPE	<input checked="" type="checkbox"/>
Address/Control Compression	<input type="checkbox"/>
Protocol Field Compression	<input type="checkbox"/>
Asyncmap Value	<input type="text" value="ffffff"/>
MRU	<input type="text" value="1500"/>
MTU	<input type="text" value="1500"/>
Link Detection Interval(s)	<input type="text" value="60"/>
Max Retries	<input type="text" value="0"/>
Expert Options	<input type="text"/>

Figure 4-2-8-8

PPTP Advanced Settings	
Item	Description
Local IP Address	Set IP address of PPTP client.
Peer IP Address	Enter tunnel IP address of PPTP server.
Enable NAT	Enable the NAT faction of PPTP.
Enable MPPE	Enable MPPE encryption.
Address/Control Compression	For PPP initialization. User can keep the default option.
Protocol Field Compression	For PPP initialization. User can keep the default option.
Asyncmap Value	One of the PPP protocol initialization strings. User can keep the default value. Range: 0-ffffff.
MRU	Enter the maximum receive unit. Range: 0-1500.
MTU	Enter the maximum transmission unit. Range: 0-1500.
Link Detection Interval (s)	Set the link detection interval time to ensure tunnel connection. Range: 0-600.
Max Retries	Set the maximum times of retrying to detect the PPTP connection failure. Range: 0-10.
Expert Options	User can enter some other PPP initialization strings in this field and separate the strings with blank space.

Table 4-2-8-8 PPTP Parameters

Related Configuration Example

[PPTP Application Example](#)

4.2.8.6 OpenVPN Client

OpenVPN is an open source virtual private network (VPN) product that offers a simplified security framework, modular network design, and cross-platform portability.

Advantages of OpenVPN include:

- Security provisions that function against both active and passive attacks.
- Compatibility with all major operating systems.
- High speed (1.4 megabytes per second typically).
- Ability to configure multiple servers to handle numerous connections simultaneously.
- All encryption and authentication features of the OpenSSL library.
- Advanced bandwidth management.
- A variety of tunneling options.
- Compatibility with smart cards that support the Windows Crypt application program interface (API).

DMVPN	IPsec	GRE	L2TP	PPTP	OpenVPN Client	OpenVPN Server	Certificatio
OpenVPN Client Settings							
— OpenVPN_1							
Enable	<input checked="" type="checkbox"/>						
Protocol	UDP						
Remote IP Address							
Port	1194						
Interface	tun						
Authentication	None						
Local Tunnel IP							
Remote Tunnel IP							
Enable NAT	<input checked="" type="checkbox"/>						
Compression	LZO						
Link Detection Interval(s)	60						
Link Detection Timeout(s)	300						
Cipher	None						
MTU	1500						
Max Frame Size	1500						
Verbose Level	ERROR						
Expert Options							
Local Route							
	Subnet		Subnet Mask		Operation		
						+	

Figure 4-2-8-9

OpenVPN Client	
Item	Description
Enable	Enable OpenVPN client. A maximum of 3 tunnels is allowed.
Protocol	Select from "UDP" and "TCP".
Remote IP Address	Enter remote OpenVPN server's IP address or domain name.
Port	Enter the listening port number of remote OpenVPN server. Range: 1-65535.
Interface	Select from "tun" and "tap".
Authentication	Select from "None", "Pre-shared", "Username/Password", "X.509 cert", and "X.509 cert+user".
Local Tunnel IP	Set local tunnel address.
Remote Tunnel IP	Enter remote tunnel address.
Global Traffic Forwarding	All the data traffic will be sent out via OpenVPN tunnel when this function is enabled.
Enable TLS Authentication	Check to enable TLS authentication.
Username	Enter username provided by OpenVPN server.
Password	Enter password provided by OpenVPN server.
Enable NAT	Enable NAT traversal function.
Compression	Select LZO to compress data.
Link Detection Interval (s)	Set link detection interval time to ensure tunnel connection. Range: 10-1800.
Link Detection Timeout (s)	Set link detection timeout. OpenVPN will be reestablished after timeout. Range: 60-3600.
Cipher	Select from "NONE", "BF-CBC", "DE-CBC", "DES-EDE3-CBC", "AES-128-CBC", "AES-192-CBC" and "AES-256-CBC".
MTU	Enter the maximum transmission unit. Range: 128-1500.
Max Frame Size	Set the maximum frame size. Range: 128-1500.
Verbose Level	Select from "ERROR", "WARNING", "NOTICE" and "DEBUG".
Expert Options	User can enter some other PPP initialization strings in this field and separate the strings with blank space.
Local Route	
Subnet	Set the local route's IP address.
Subnet Mask	Set the local route's netmask.

Table 4-2-8-9 OpenVPN Client Parameters

4.2.8.7 OpenVPN Server

The UR75 supports OpenVPN server to create secure point-to-point or site-to-site connections in routed or bridged configurations and remote access facilities.

DMVPN	IPsec	GRE	L2TP	PPTP	OpenVPN Client	OpenVPN Server
OpenVPN Server Settings						
Enable	<input type="checkbox"/>					
Protocol	UDP					
Port	1194					
Listening IP						
Interface	tun					
Authentication	None					
Local Virtual IP						
Remote Virtual IP						
Enable NAT	<input checked="" type="checkbox"/>					
Compression	LZO					
Link Detection Interval	60					
Cipher	None					
MTU	1500					
Max Frame Size	1500					
Verbose Level	ERROR					
Expert Options						

Figure 4-2-8-10

Local Route		
Subnet	Netmask	Operation
		+
Account		
Username	Password	Operation
		+

Figure 4-2-8-11

OpenVPN Server	
Item	Description
Enable	Enable/disable OpenVPN server.
Protocol	Select from TCP and UDP.
Port	Fill in listening port number. Range: 1-65535.
Listening IP	Enter WAN IP address or LAN IP address. Leaving it blank refers to all active WAN IP and LAN IP address.
Interface	Select from " tun" and "tap".
Authentication	Select from "None", "Pre-shared", "Username/Password", "X.509 cert" and "X. 509 cert +user".
Local Virtual IP	The local tunnel address of OpenVPN's tunnel.
Remote Virtual IP	The remote tunnel address of OpenVPN's tunnel.
Client Subnet	Local subnet IP address of OpenVPN client.
Client Netmask	Local netmask of OpenVPN client.
Renegotiation Interval(s)	Set interval for renegotiation. Range: 0-86400.
Max Clients	Maximum OpenVPN client number. Range: 1-128.
Enable CRL	Enable CRL
Enable Client to Client	Allow access between different OpenVPN clients.
Enable Dup Client	Allow multiple users to use the same certification.
Enable NAT	Check to enable the NAT traversal function.
Compression	Select "LZO" to compress data.
Link Detection Interval	Set link detection interval time to ensure tunnel connection. Range: 10-1800.
Cipher	Select from "NONE", "BF-CBC", "DES-CBC", "DES-EDE3-CBC", "AES-128-CBC", "AES-192-CBC" and "AES-256-CBC".
MTU	Enter the maximum transmission unit. Range: 64-1500.
Max Frame Size	Set the maximum frame size. Range: 64-1500.
Verbose Level	Select from "ERROR", "WARNING", "NOTICE" and "DEBUG".
Expert Options	User can enter some other PPP initialization strings in this field and separate the strings with blank space.
Local Route	
Subnet	The real local IP address of OpenVPN client.
Netmask	The real local netmask of OpenVPN client.
Account	
Username & Password	Set username and password for OpenVPN client.

Table 4-2-8-10 OpenVPN Server Parameters

4.2.8.8 Certifications

User can import/export certificate and key files for OpenVPN and IPsec on this page.

Figure 4-2-8-12

OpenVPN Client	
Item	Description
CA	Import/Export CA certificate file.
Public Key	Import/Export public key file.
Private Key	Import/Export private key file.
TA	Import/Export TA key file.
Preshared Key	Import/Export static key file.
PKCS12	Import/Export PKCS12 certificate file.

Table 4-2-8-11 OpenVPN Client Certification Parameters

Figure 4-2-8-13

OpenVPN Server	
Item	Description
CA	Import/Export CA certificate file.
Public Key	Import/Export public key file.
Private Key	Import/Export private key file.
DH	Import/Export DH key file.
TA	Import/Export TA key file.
CRL	Import/Export CRL.
Preshared Key	Import/Export static key file.

Table 4-2-8-12 OpenVPN Server Parameters

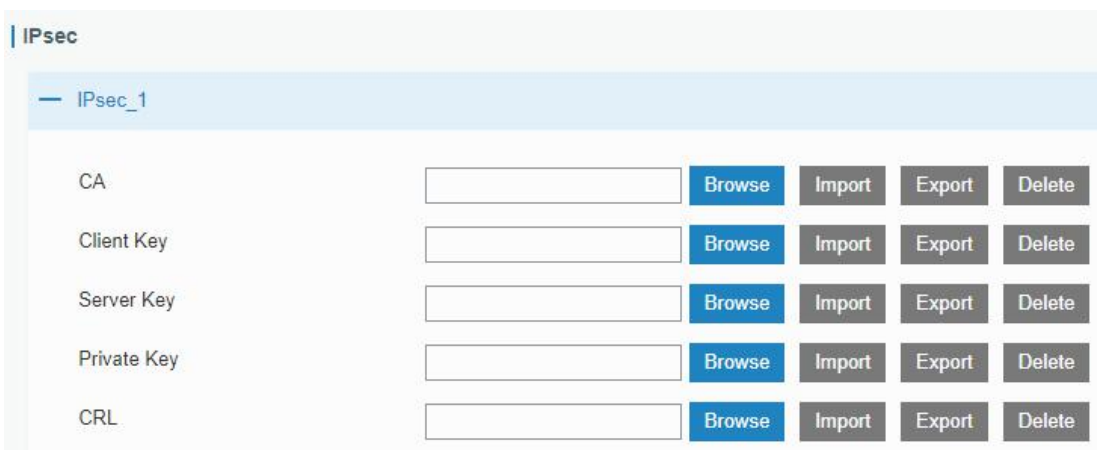

Figure 4-2-8-14

IPsec	
Item	Description
CA	Import/Export CA certificate.
Client Key	Import/Export client key.
Server Key	Import/Export server key.
Private Key	Import/Export private key.
CRL	Import/Export certificate recovery list.

Table 4-2-8-13 IPsec Parameters

4.3 System

This section describes how to configure general settings, such as administration account, access service, system time, common user management, SNMP, AAA, event alarms, etc.

4.3.1 General Settings

4.3.1.1 General

General settings include system info, access service and HTTPS certificates.

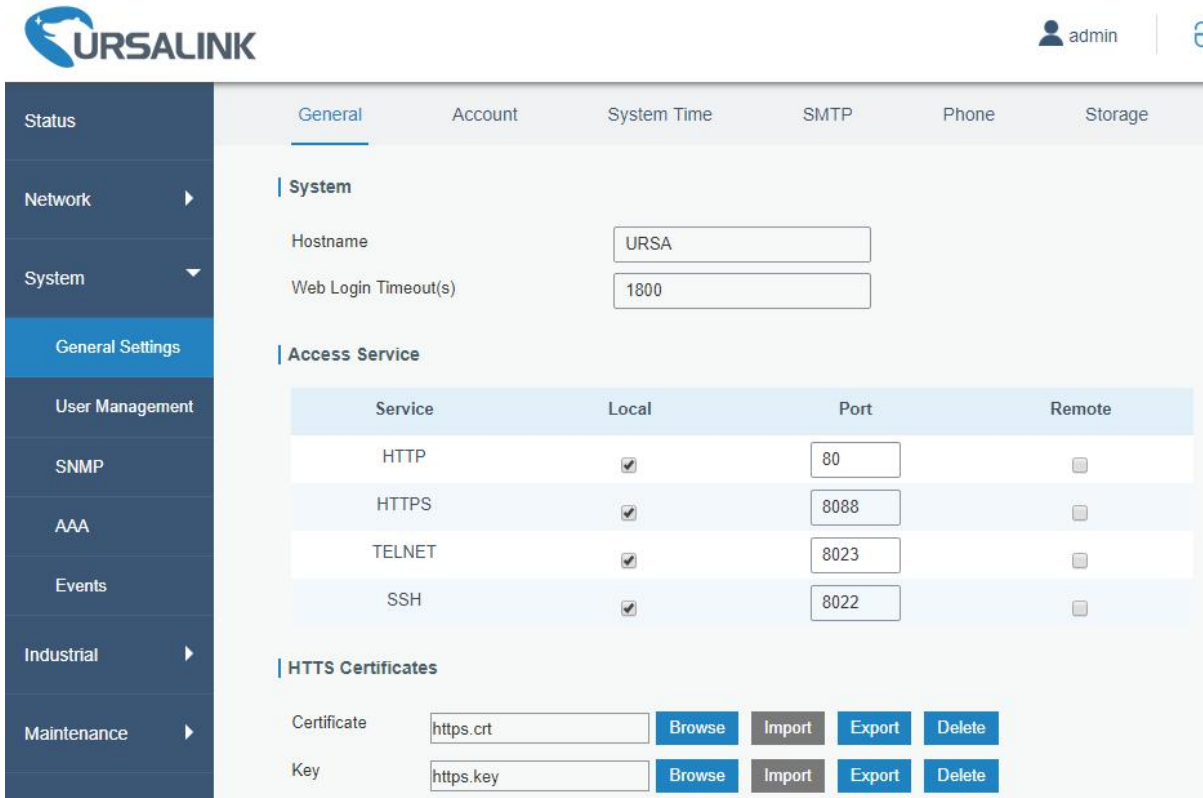

Figure 4-3-1-1

General		
Item	Description	Default
System		
Hostname	User-defined router name, needs to start with a letter.	URSA
Web Login Timeout (s)	You need to log in again if it times out. Range: 100-3600.	1800
Access Service		
Local	Access the router locally.	Enable
Port	Set port number of the services. Range: 1-65535.	--
Remote	Access the router remotely.	Disable
HTTP	Users can log in the device locally via HTTP to access and control it through Web after the option is checked.	80
HTTPS	Users can log in the device locally and remotely via HTTPS to access and control it through Web after option is checked.	8088
TELNET	Users can log in the device locally and remotely via Telnet after the option is checked.	8023
SSH	Users can log in the device locally and remotely via SSH after the option is checked.	8022

Table 4-3-1-1 General Setting Parameters

Item	Description	Default
HTTPS Certificates		
Certificate	Click "Browse" button, choose certificate file on the PC, and then click "Import" button to upload the file into router. Click "Export" button will export the file to the PC. Click "Delete" button will delete the file.	--
Key	Click "Browse" button, choose key file on the PC, and then click "Import" button to upload the file into router. Click "Export" button will export file to the PC. Click "Delete" button will delete the file.	--

Table 4-3-1-2 General Setting Parameters

4.3.1.2 Account Management

Here you can change the login username and password of the administrator.

Note: it is strongly recommended that you modify them for the sake of security.

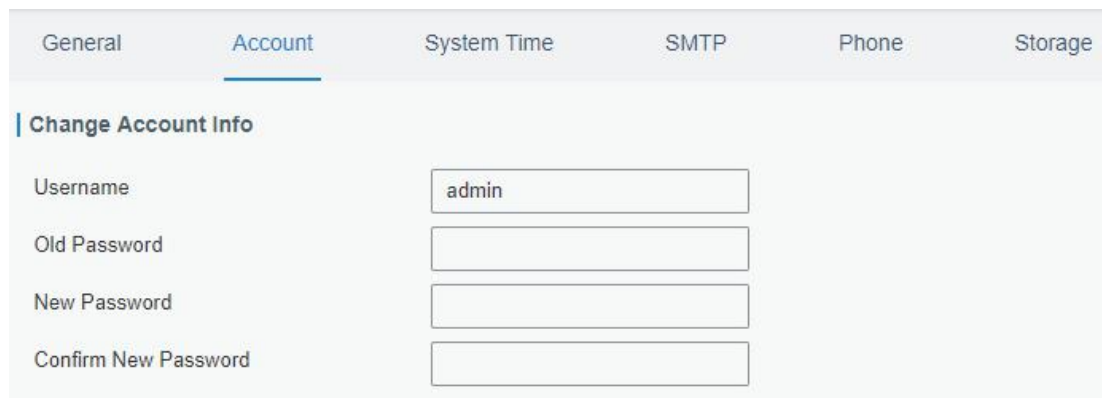

Figure 4-3-1-2

Account	
Item	Description
Username	Enter a new username. You can use characters such as a-z, 0-9, "_", "-", "\$". The first character can't be a digit.
Old Password	Enter the old password.
New Password	Enter a new password.
Confirm New Password	Enter the new password again.

Table 4-3-1-3 Account Information

Related Configuration Example

[Account Info Management](#)

4.3.1.3 System Time

This section explains how to set the system time including time zone and time synchronization type.

Note: to ensure that the router runs with the correct time, it's recommended that you set the system time when configuring the router.

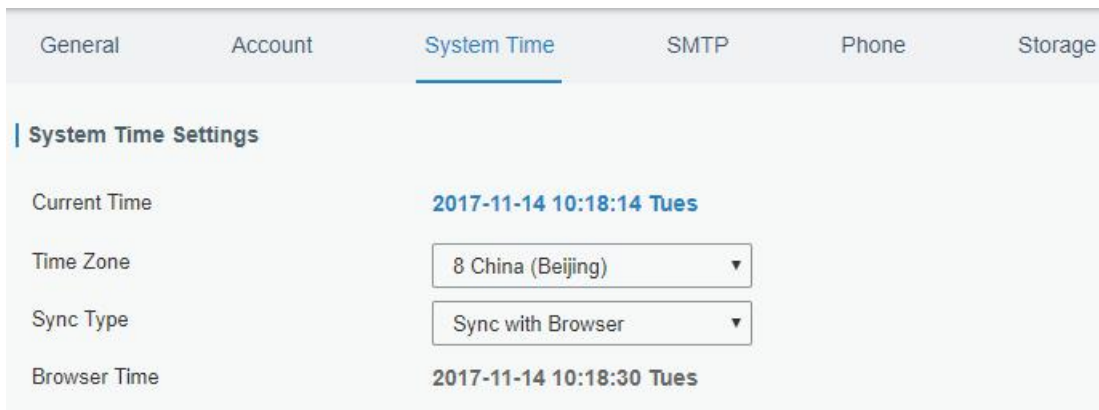

The screenshot shows the 'System Time' configuration page. The 'Sync Type' dropdown is set to 'Sync with Browser'. The current time is 2017-11-14 10:18:14 Tues, and the browser time is 2017-11-14 10:18:30 Tues. The time zone is 8 China (Beijing).

Figure 4-3-1-3

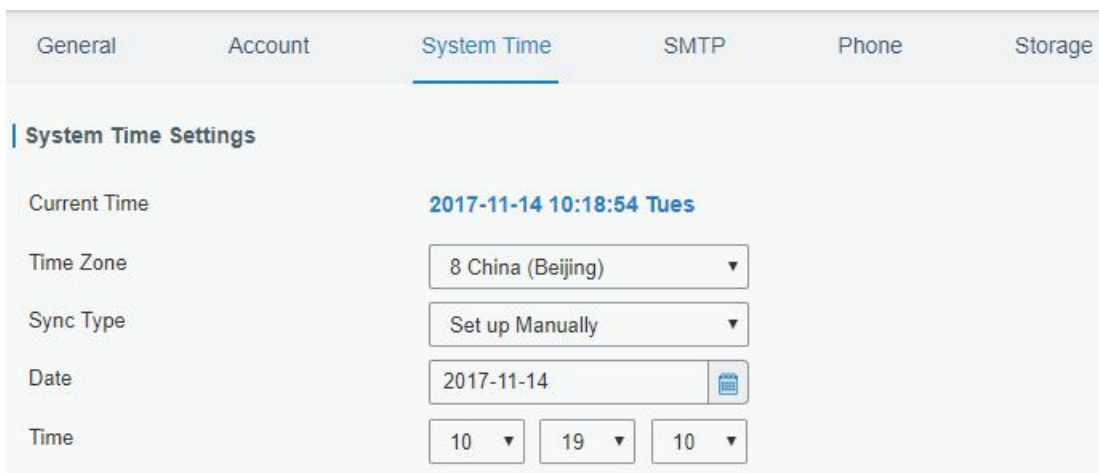

The screenshot shows the 'System Time' configuration page with 'Set up Manually' selected for 'Sync Type'. The current time is 2017-11-14 10:18:54 Tues. The date is set to 2017-11-14 and the time is 10:19:10. The time zone is 8 China (Beijing).

Figure 4-3-1-4

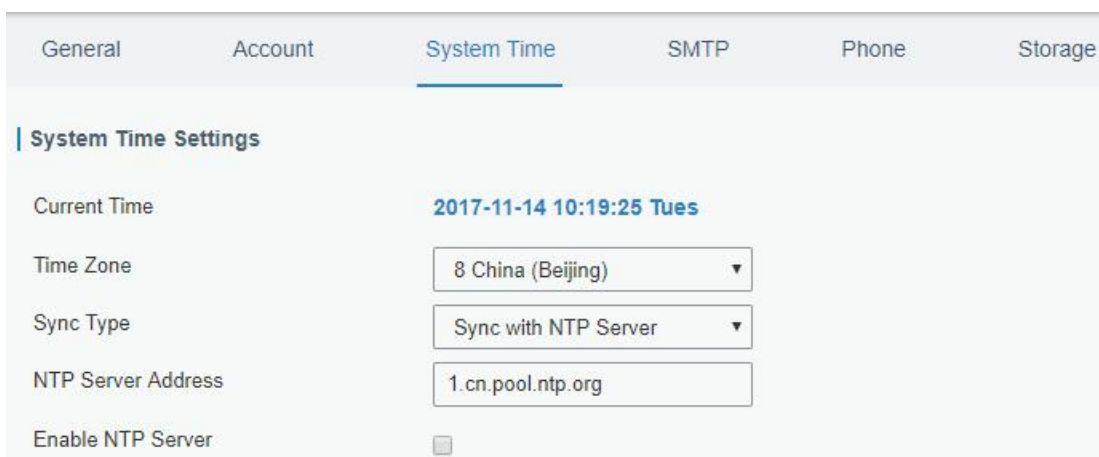

The screenshot shows the 'System Time' configuration page with 'Sync with NTP Server' selected for 'Sync Type'. The current time is 2017-11-14 10:19:25 Tues. The NTP Server Address is 1.cn.pool.ntp.org. The 'Enable NTP Server' checkbox is unchecked. The time zone is 8 China (Beijing).

Figure 4-3-1-5

System Time	
Item	Description
Current Time	Show the current system time.
Time Zone	Click the drop down list to select the time zone you are in.
Sync Type	Click the drop down list to select the time synchronization

	type.
Sync with Browser	Synchronize time with browser.
Browser Time	Show the current time of browser.
Set up Manually	Manually configure the system time.
Sync with NTP Server	Synchronize time with NTP server so as to achieve time synchronization of all devices equipped with a clock on network.
Sync with NTP Server	
NTP Server Address	Set NTP server address (domain name/IP).
Enable NTP Server	NTP client on the network can achieve time synchronization with router after "Enable NTP Server" option is checked.

Table 4-3-1-4 System Time Parameters

Related Configuration Example

[System Time Management](#)

4.3.1.4 SMTP

SMTP, short for Simple Mail Transfer Protocol, is a TCP/IP protocol used in sending and receiving e-mail. This section describes how to configure email settings.

Figure 4-3-1-6

SMTP	
Item	Description
SMTP Client Settings	

Enable	Enable or disable SMTP client function.
Email Address	Enter the sender's email account.
Password	Enter the sender's email password.
SMTP Server Address	Enter SMTP server's domain name.
Port	Enter SMTP server port. Range: 1-65535.
Enable TLS	Enable or disable TLS encryption.
Email Recipients	
Email Address	Add recipients' email address.
Test	Check if the recipients can get the mail from sender.

Table 4-3-1-5 SMTP Setting

Related Topics

[DI Setting](#)

[Events Setting](#)

[Events Application Example](#)

4.3.1.5 Phone

Phone settings involve in call/SMS trigger and SMS alarm for events.

1. Add phone list.
2. Select phone numbers and add them to the phone group.
3. Go to “Network > Interface > Cellular > Connection Mode > Connect on Demand > Trigger by Call / Trigger by SMS” or go to “System > Events > Event Settings > SMS” and then select the phone group ID.

The screenshot shows the 'Phone' settings page with tabs for General, Account, System Time, SMTP, Phone, and Storage. The 'Phone' tab is active. It contains two main sections: 'Phone Number List' and 'Phone Group List'.

Phone Number List: A table with columns 'Number', 'Description', and 'Operation'. It contains one entry: Number '+8613409876543', Description 'adm', and an 'X' icon for deletion. A '+' icon is at the bottom right for adding new numbers.

Phone Group List: A form with fields for 'Group ID' (value: 1) and 'Description' (value: sms). Below these are two list boxes: 'List' (containing '+8613409876543') and 'Selected' (empty). Between the list boxes are four arrow buttons: a right arrow, a right arrow with a plus sign, a left arrow, and a left arrow with a plus sign. At the bottom are 'Save' and 'Cancel' buttons.

Figure 4-3-1-7

Phone	
Item	Description
Phone Number List	
Number	Enter the telephone number. Digits, "+" and "-" are allowed.
Description	The description of the telephone number.
Phone Group	
Group ID	Set number for phone group. Range: 1-100.
Description	The description of the phone group.
List	Show the phone list.
Selected	Show the selected phone number.

Table 4-3-1-6 Phone Settings

Related Topic

[Connect on Demand](#)

4.3.1.6 Storage

You can view Micro SD card and SSD storage information on this page.

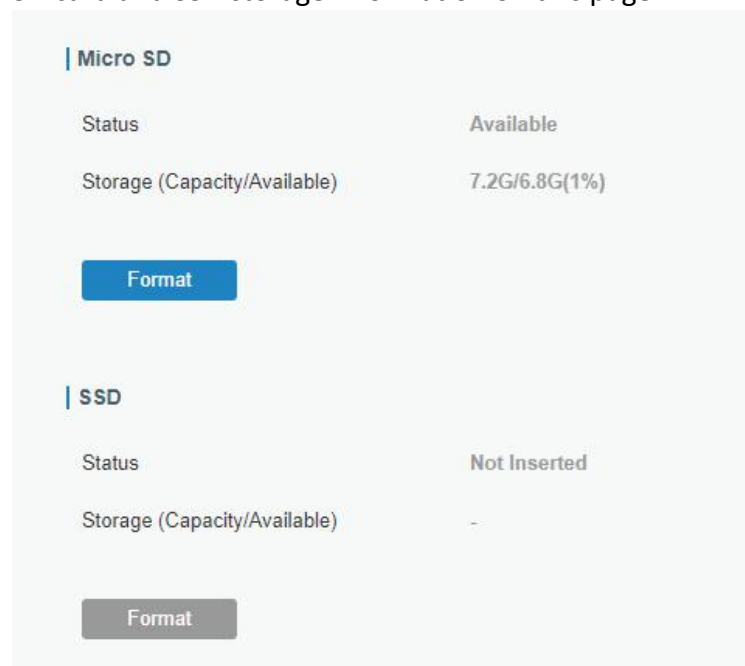

Figure 4-3-1-8

Storage	
Item	Description
Status	Show the status of Micro SD card or SSD, such as "Available" or "Not Inserted".
Storage (Capacity/Available)	The total capacity of the Micro SD Card or SSD.
Format	Format the Micro SD card or SSD.

Table 4-3-1-7 Storage Information

4.3.2 User Management

This section describes how to create common user accounts.

The common user permission includes Read-Only and Read-Write.

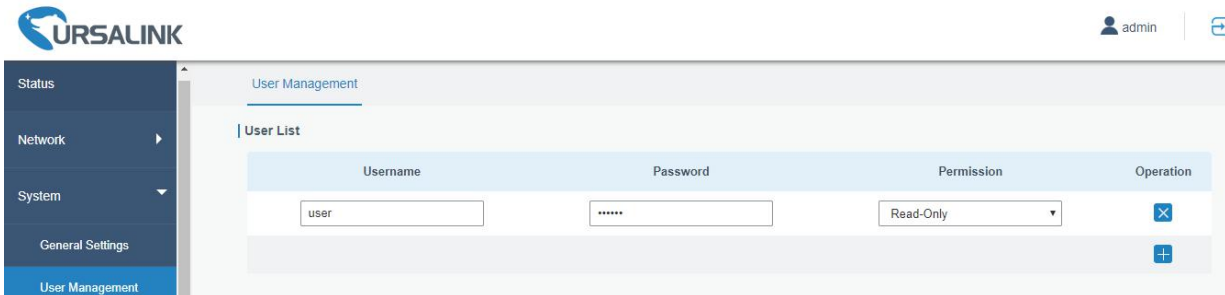

Figure 4-3-2-1

User Management	
Item	Description
Username	Enter a new username. You can use characters such as a-z, 0-9, "_", "-", "\$". The first character can't be a digit.
Password	Set password.
Permission	Select user permission from "Read-Only" and "Read-Write". <ul style="list-style-type: none"> - Read-Only: users can only view the configuration of router in this level. - Read-Write: users can view and set the configuration of router in this level.

Table 4-3-2-1 User Management

Related Configuration Example

[Common User Management](#)

4.3.3 SNMP

SNMP is widely used in network management for network monitoring. SNMP exposes management data with variables form in managed system. The system is organized in a management information base (MIB) which describes the system status and configuration. These variables can be remotely queried by managing applications.

Configuring SNMP in networking, NMS, and a management program of SNMP should be set up at the Manager.

Configuration steps are listed as below for achieving query from NMS:

1. Enable SNMP setting.
2. Download MIB file and load it into NMS.
3. Configure MIB View.
4. Configure VCAM.

Related Configuration Example

[SNMP Application Example](#)

4.3.3.1 SNMP

The UR75 supports SNMPv1, SNMPv2c and SNMPv3 version. SNMPv1 and SNMPv2c employ community name authentication. SNMPv3 employs authentication encryption by username and password.

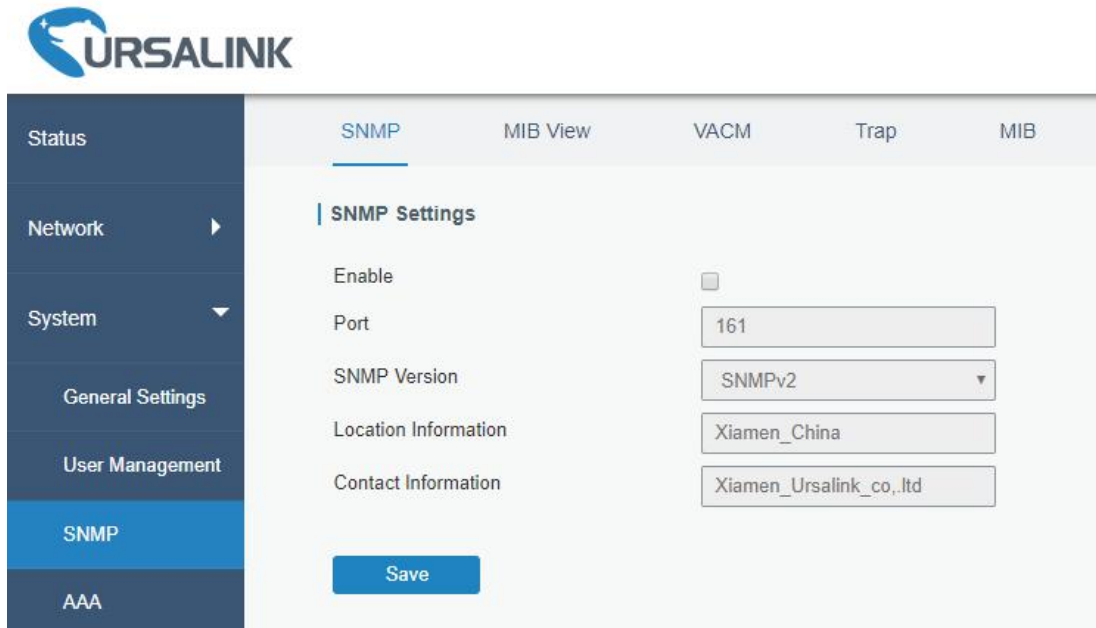

Figure 4-4-3-1

SNMP Settings	
Item	Description
Enable	Enable or disable SNMP function.
Port	Set SNMP listened port. Range: 1-65535. The default port is 161.
SNMP Version	Select SNMP version; support SNMP v1/v2c/v3.
Location Information	Fill in the location information.
Contact Information	Fill in the contact information.

Table 4-4-3-1 SNMP Parameters

4.3.3.2 MIB View

This section explains how to configure MIB view for the objects.

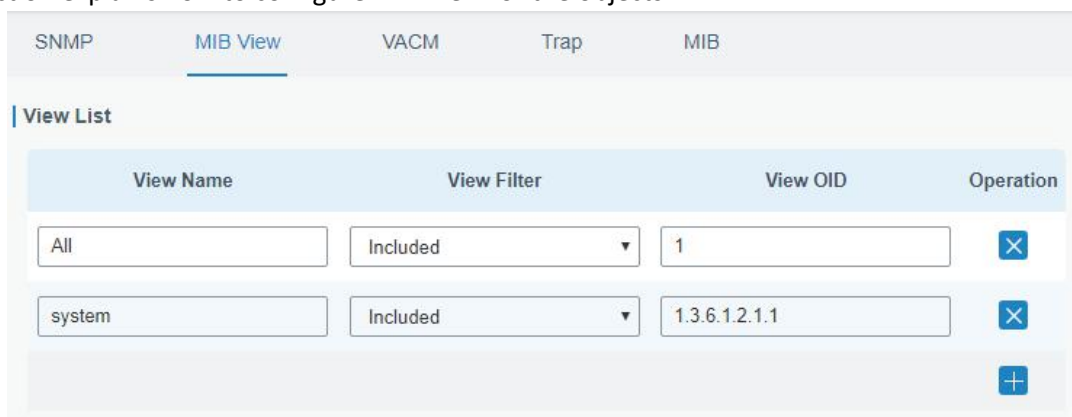

Figure 4-4-3-2

MIB View	
Item	Description
View Name	Set MIB view's name.
View Filter	Select from "Included" and "Excluded".
View OID	Enter the OID number.
Included	You can query all nodes within the specified MIB node.
Excluded	You can query all nodes except for the specified MIB node.

Table 4-3-3-2 MIB View Parameters

4.3.3.3 VACM

This section describes how to configure VCAM parameters.

The screenshot shows a web interface with tabs for SNMP, MIB View, VACM (selected), Trap, and MIB. Below the tabs is a section titled "SNMP v1 & v2 User List" containing a table with columns: Community, Permission, MIB View, Network, and Operation. Two rows are visible: one for 'private' with 'Read-write' permission and 'All' MIB View, and another for 'public' with 'Read-only' permission and 'none' MIB View. Both rows have a network address of '0.0.0.0/0'. There are 'X' icons for deletion and a '+' icon for adding new entries.

Figure 4-3-3-3

VACM	
Item	Description
SNMP v1 & v2 User List	
Community	Set the community name.
Permission	Select from "Read-Only" and "Read-Write".
MIB View	Select an MIB view to set permissions from the MIB view list.
Network	The IP address and bits of the external network accessing the MIB view.
Read-Write	The permission of the specified MIB node is read and write.
Read-Only	The permission of the specified MIB node is read only.
SNMP v3 User List	
Group Name	Set the name of SNMPv3 group.
Security Level	Select from "NoAuth/NoPriv", "Auth/NoPriv", and "Auth/Priv".
Read-Only View	Select an MIB view to set permission as "Read-only" from the MIB view list.
Read-Write View	Select an MIB view to set permission as "Read-write" from the MIB view list.
Inform View	Select an MIB view to set permission as "Inform" from the MIB view list.

Table 4-3-3-3 VACM Parameters

4.3.3.4 Trap

This section explains how to enable network monitoring by SNMP trap.

Figure 4-3-3-4

SNMP Trap	
Item	Description
Enable	Enable or disable SNMP Trap function.
SNMP Version	Select SNMP version; support SNMP v1/v2c/v3.
Server Address	Fill in NMS's IP address or domain name.
Port	Fill in UDP port. Port range is 1-65535. The default port is 162.
Name	Fill in the group name when using SNMP v1/v2c; fill in the username when using SNMP v3.
Auth/Priv Mode	Select from "NoAuth & No Priv", "Auth & NoPriv", and "Auth & Priv".

Table 4-3-3-4 Trap Parameters

4.3.3.5 MIB

This section describes how to download MIB files. The last MIB file "URSA-ROUTER-MIB.txt" is for the UR75 router.

Figure 4-3-3-5

MIB	
Item	Description
MIB File	Select the MIB file you need.
Download	Click "Download" button to download the MIB file to PC.

Table 4-3-3-5 MIB Download

4.3.4 AAA

AAA access control is used for visitors control and the available corresponding services once access is allowed. It adopts the same method to configure three independent safety functions. It provides modularization methods for following services:

- Authentication: verify if the user is qualified to access to the network.
- Authorization: authorize related services available for the user.
- Charging: record the utilization of network resources.

4.3.4.1 Radius

Using UDP for its transport, Radius is generally applied in various network environments with higher requirements of security and permission of remote user access.

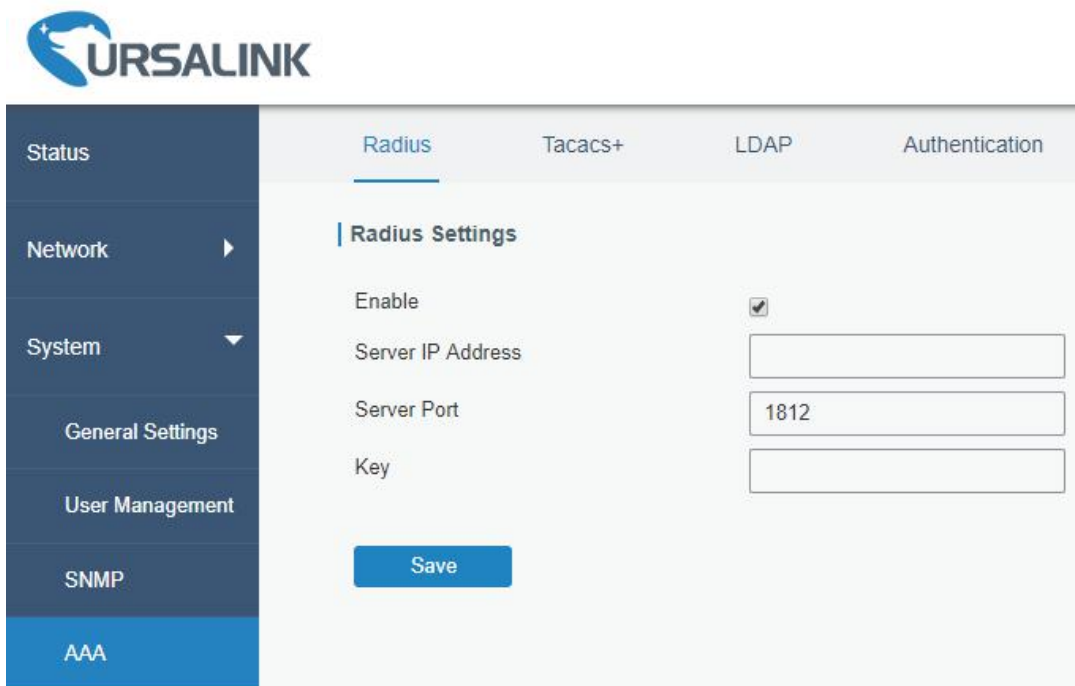

Figure 4-3-4-1

Radius	
Item	Description
Enable	Enable or disable Radius.
Server IP Address	Fill in the Radius server IP address/domain name.
Server Port	Fill in the Radius server port. Range: 1-65535.
Key	Fill in the key consistent with that of Radius server in order to get connected with Radius server.

Table 4-3-4-1 Radius Parameters

4.3.4.2 TACACS+

Using TCP for its transport, TACACS+ is mainly used for authentication, authorization and charging of the access users and terminal users by adopting PPP and VPDN.

Figure 4-3-4-2

TACACS+	
Item	Description
Enable	Enable or disable TACACS+.
Server IP Address	Fill in the TACACS+ server IP address/domain name.
Server Port	Fill in the TACACS+ server port. Range: 1-65535.
Key	Fill in the key consistent with that of TACACS+ server in order to get connected with TACACS+ server.

Table 4-3-4-2 TACACS+ Parameters

4.3.4.3 LDAP

A common usage of LDAP is to provide a central place to store usernames and passwords. This allows many different applications and services to connect the LDAP server to validate users.

LDAP is based on a simpler subset of the standards contained within the X.500 standard. Because of this relationship, LDAP is sometimes called X.500-lite as well.

Figure 4-3-4-3

LDAP	
Item	Description
Enable	Enable or Disable LDAP.
Server IP Address	Fill in the LDAP server's IP address/domain name. The maximum count is 10.
Server Port	Fill in the LDAP server's port. Range: 1-65535
Base DN	The top of LDAP directory tree.
Security	Select secure method from "None", "StartTLS" and "SSL".
Username	Enter the username to access the server.
Password	Enter the password to access the server.

Table 4-3-4-3 LDAP Parameters

4.3.4.4 Authentication

AAA supports the following authentication ways:

- None: uses no authentication, generally not recommended.
- Local: uses the local username database for authentication.
 - Advantages: rapidness, cost reduction.
 - Disadvantages: storage capacity limited by hardware.
- Remote: has user's information stored on authentication server. Radius, TACACS+ and LDAP supported for remote authentication.

When radius, TACACS+, and local are configured at the same time, the priority level is: 1 > 2 > 3.



Figure 4-3-4-4

Authentication	
Item	Description
Console	Select authentication for Console access.
Web	Select authentication for Web access.
Telnet	Select authentication for Telnet access.
SSH	Select authentication for SSH access.

Table 4-3-4-4 Authentication Parameters

4.3.5 Device Management

You can connect the device to the DeviceHub on this page so as to manage the router.

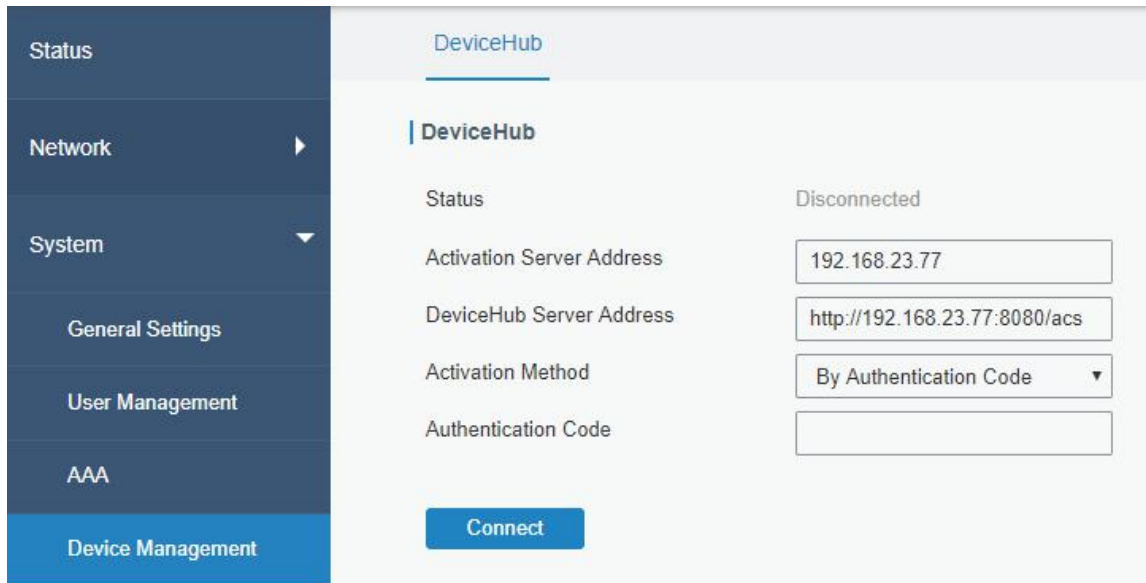

Figure 4-3-5-1

DeviceHub	
Item	Description
Status	Show the connection status between the router and the DeviceHub.
Disconnected	Click this button to disconnect the router from the DeviceHub.
Activation Server Address	IP address or domain of the DeviceHub.
DeviceHub Server Address	The URL address for the device to connect to the DeviceHub, e.g. http://220.82.63.79:8080/acs.
Activation Method	Select activation method to connect the router to the DeviceHub server, options are "By Authentication ID" and "By ID".
Authentication Code	Fill in the authentication code generated from the DeviceHub.
ID	Fill in the registered DeviceHub account (email) and password.
Password	

Table 4-3-5-1

4.3.6 Events

Event feature is capable of sending alerts by Email when certain system events occur.

4.3.6.1 Events

You can view alarm messages on this page.

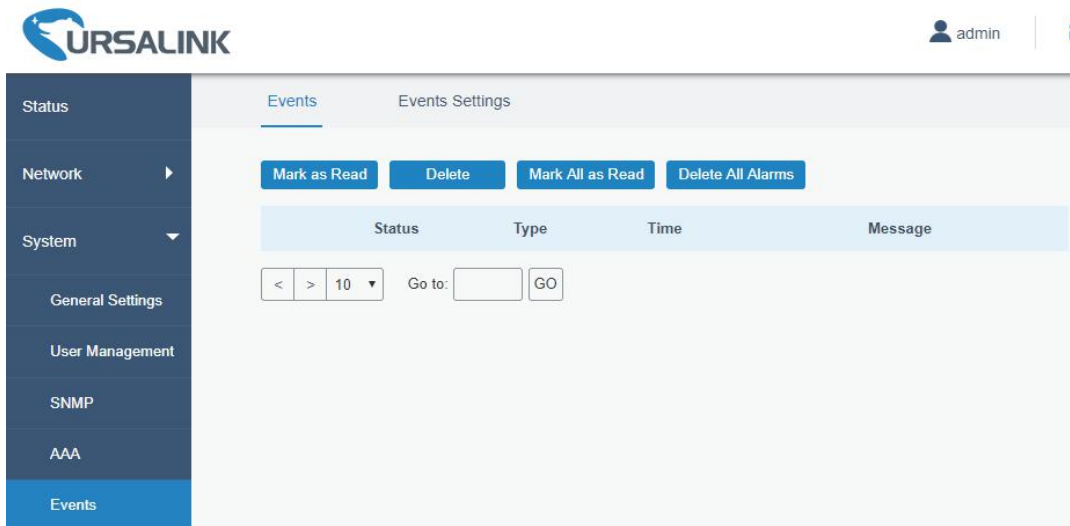

Figure 4-3-6-1

Events	
Item	Description
Mark as Read	Mark the selected event alarm as read.
Delete	Delete the selected event alarm.
Mark All as Read	Mark all event alarms as read.
Delete All Alarms	Delete all event alarms.
Status	Show the reading status of the event alarms, such as “Read” and “Unread”.
Type	Show the event type that should be alarmed.
Time	Show the alarm time.
Message	Show the alarm content.

Table 4-3-6-1 Events Parameters

4.3.6.2 Events Settings

In this section, you can decide what events to record and whether you want to receive email and SMS notifications when any change occurs.

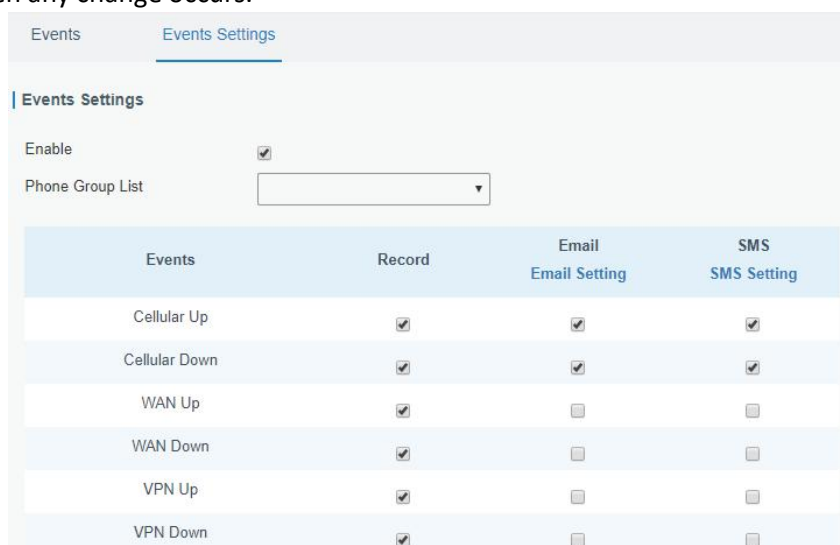

Figure 4-3-6-2

Event Settings	
Item	Description
Enable	Check to enable "Events Settings".
Cellular Up	Cellular network is connected.
Cellular Down	Cellular network is disconnected.
WAN Up	Ethernet cable is connected to WAN port.
WAN Down	Ethernet cable is disconnected to WAN port.
VPN Up	VPN is connected.
VPN Down	VPN is disconnected.
Record	The relevant content of event alarm will be recorded on "Event" page if this option is checked.
Email	The relevant content of event alarm will be sent out via email if this option is checked.
Email Setting	Click and you will be redirected to the page "SMTP" to configure the sender's & recipients' info.
SMS	The relevant content of event alarm will be sent out via SMS if this option is checked.
SMS Setting	Click and you will be redirected to the page of "Phone" to configure phone group list.
Phone Group List	Select phone group to receive SMS alarm.

Table 4-3-6-2 Events Parameters

Related Topics

[Email Setting](#)

[Events Application Example](#)

4.4 Industrial Interface

The UR75 router is capable of connecting with terminals through industrial interfaces so as to realize wireless communication between terminals and remote data center.

There are two types of the router’s industrial interface: serial port (RS232 and RS485) and I/O (digital input and digital output).

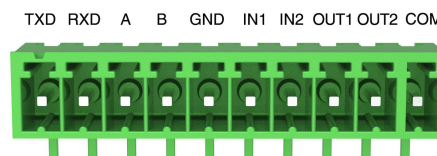

Figure 4-4-1 Pinouts

PIN	RS232*1	RS485*1	DI*2	DO*2	Description
1	TXD	---	---	---	Transmit Data
2	RXD	---	---	---	Receive Data
3	---	A	---	---	Data +
4	---	B	---	---	Data -
5	GND	---	GND	---	Ground
6	---	---	IN1	---	Digital Input1
7	---	---	IN2	---	Digital Input2
8	---	---	---	OUT1	Digital Output1
9	---	---	---	OUT2	Digital Output2
10	---	---	---	COM	Common Ground

Table 4-4-1 Pinouts Definition

RS232 adopts full-duplex communication. It’s generally used for communication within 20m.

RS485 adopts half-duplex communication to achieve transmission of serial communication data with distance up to 1200 m.

Digital input of I/O interface is a logical variable or switch variable with only two values of 0 and 1. “0” refers to low level and “1” refers to high level .

4.4.1 I/O

4.4.1.1 DI

This section explains how to configure monitoring condition on digital input, and take certain actions once the condition is reached.

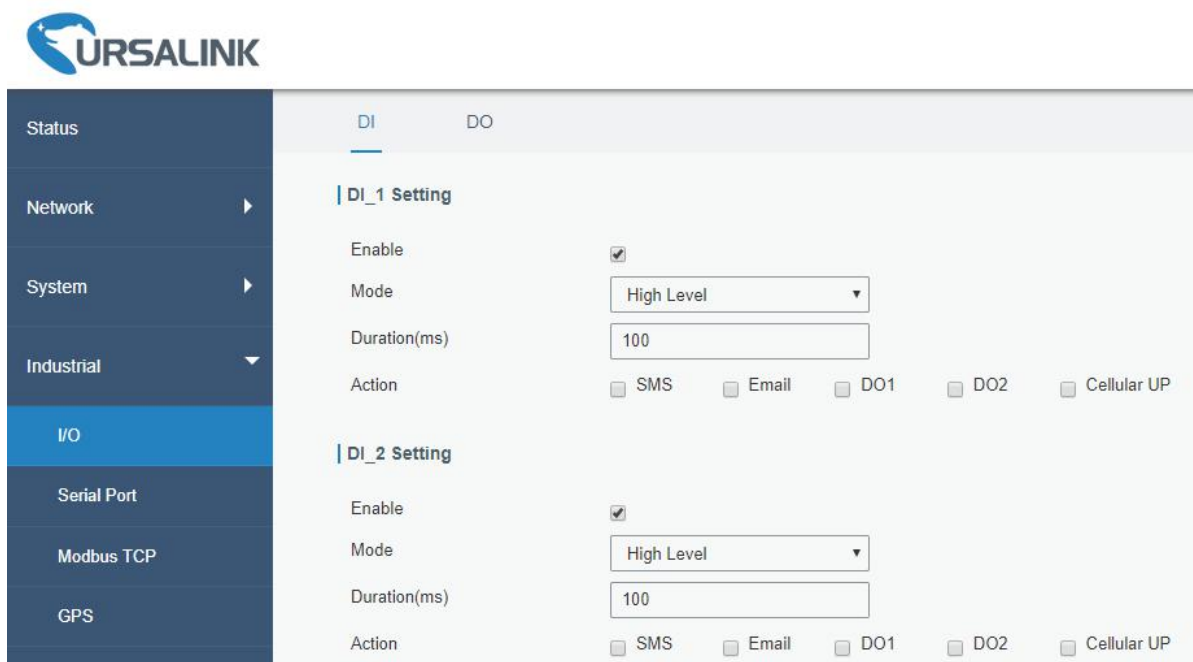

Figure 4-4-1-1

DI	
Item	Description
Enable	Enable or disable DI.
Mode	Options are "High Level", "Low Level", and "Counter".
Duration (ms)	Set the duration of high/low level in digital input. Range: 1-10000.
Condition	Select from "Low->High", and "High-> Low".
Low->High	The counter value will increase by 1 if digital input's status changes from low level to high level.
High->Low	The counter value will increase by 1 if digital input's status changes from high level to low level.
Counter	The system will take actions accordingly when the counter value reach the preset one, and then reset the counter value to 0. Range: 1-100.
Action	Select the corresponding actions that the system will take when digital input mode meets the preset condition or duration.
SMS	Check to enable SMS alarm.
Phone	Set phone number to receive SMS alarm.
Content	Set the content of SMS alarm.
Email	Check to enable Email alarm.
DO1	Control output status of DO1.
DO2	Control output status of DO2.
Cellular UP	Trigger the router to switch from offline mode to cellular network mode.

Table 4-4-1-1 DI Parameters

Related Topics

[DO Setting](#)

[Email Setting](#)

[Connect on Demand](#)

4.4.1.2 DO

This section describes how to configure digital output mode.

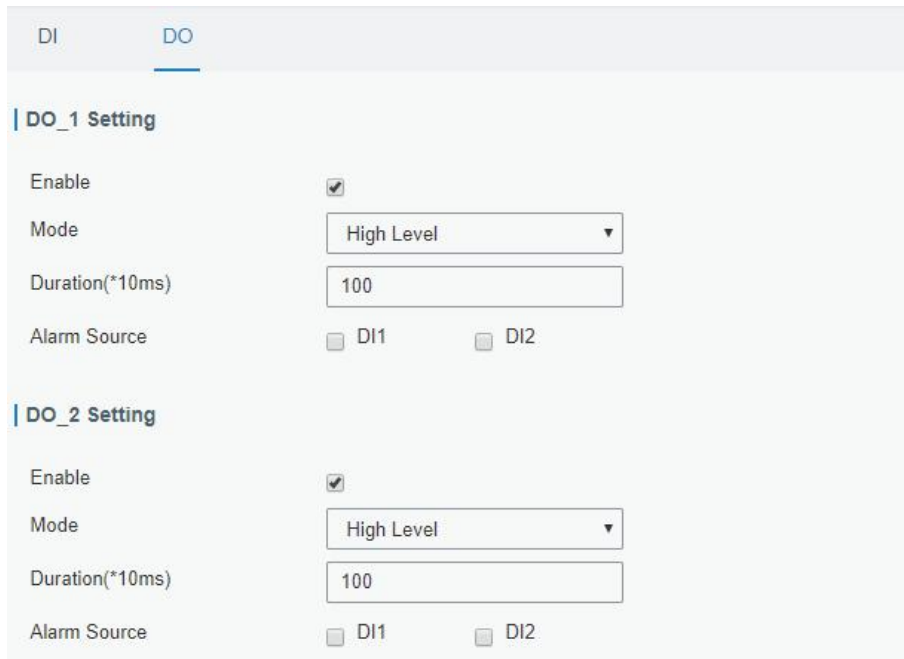

Figure 4-4-1-2

DO	
Item	Description
Enable	Enable or disable DO.
Mode	Select from "High Level", "Low Level", and "Pulse".
Duration (*10ms)	Set duration of high/low level on digital output. Range: 1-10000.
Initial Status	Select high level or low level as the initial status of the pulse.
Duration of High Level (*10ms)	Set the duration of pulse's high level. Range: 1-10000.
Duration of Low Level (*10ms)	Set the duration of pulse's low level. Range: 1-10000.
The Number of Pulse	Set the quantity of pulse. Range: 1-100.
Alarm Source	Select alarm source between "DI1" and "DI2".

Table 4-4-1-2 DO Settings

Related Topics

[DI Setting](#)

4.4.2 Serial Port

Serial 1 is used for RS232 and Serial 2 for RS485 by default.

This section explains how to configure serial port parameters to achieve communication with serial terminals, and configure work mode to achieve communication with the remote data center, so as to achieve two-way communication between serial terminals and remote data center.

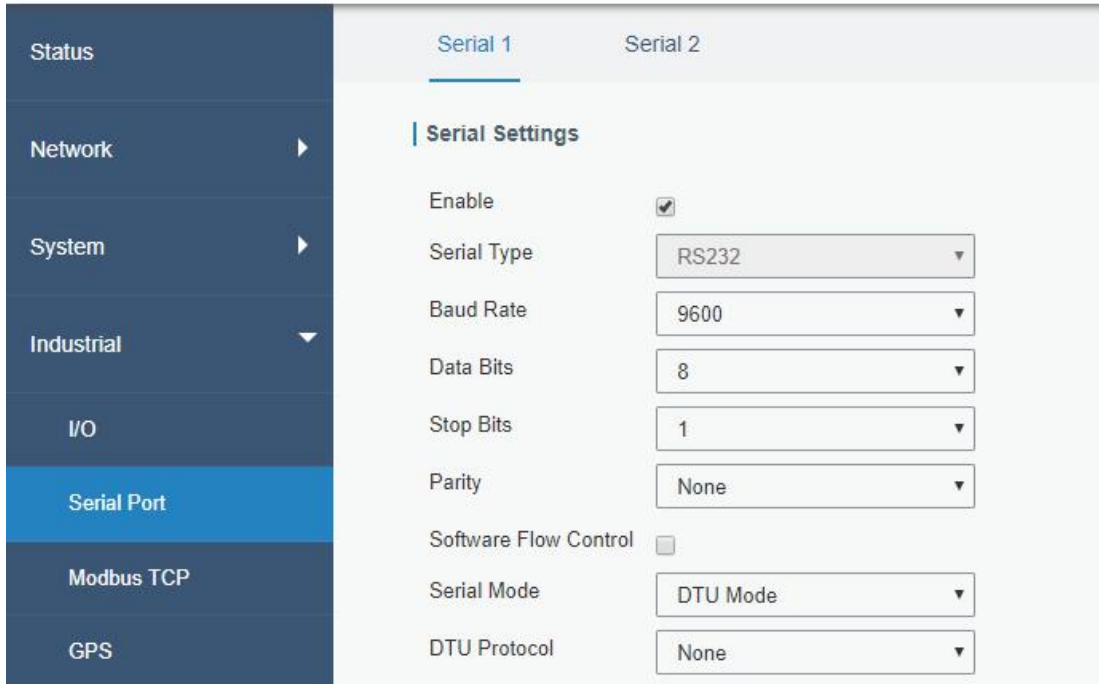

Figure 4-4-2-1

Serial Settings		
Item	Description	Default
Enable	Enable or disable serial port function.	Disable
Serial Type	Serial Port 1 is a RS232 port. Serial Port 2 is a RS485 port.	--
Baud Rate	Range is 300-230400. Same with the baud rate of the connected terminal device.	9600
Data Bits	Options are "8" and "7". Same with the data bits of the connected terminal device.	8
Stop Bits	Options are "1" and "2". Same with the stop bits of the connected terminal device.	1
Parity	Options are "None", "Odd" and "Even". Same with the parity of the connected terminal device.	None
Software Flow Control	Enable or disable software flow control.	Disable
Serial Mode	Select work mode of the serial port. Options are "DTU Mode" and "GPS".	Disable
DTU Mode	In DTU Mode, the serial port can establish communication with the remote server/client.	--
GPS	In GPS mode, go to "Industrial > GPS > GPS Serial Forwarding" to select corresponding Serial Type, then GPS data will be forwarded to this serial port.	--

Table 4-4-2-1 Serial Parameters

Serial Mode	DTU Mode
DTU Protocol	Transparent
Protocol	TCP
Keepalive Interval	75 s
Keepalive Retry Times	9
Packet Size	1024 Bytes
Serial Frame Interval	100 ms
Reconnect Interval	10 s
Specific Protocol	<input type="checkbox"/>
Register String	

Destination IP Address

Server Address	Server Port	Status	Operation
			+

Figure 4-4-2-2

DTU Mode		
Item	Description	Default
DTU Protocol	Select from "None", "Transparent", "Modbus", and "TCP server". <ul style="list-style-type: none"> - Transparent: the routed is used as TCP client/UDP and transmits data transparently. - TCP server: the router is used as TCP server and transmits data transparently. - Modbus: the router will be used as TCP server with modbus gateway function, which can achieve conversion between Modbus RTU and Modbus TCP. 	--
TCP Server		
Listening port	Set the router listening port. Range: 1-65535.	502
Keepalive Interval	After TCP connection is established, client will send heartbeat packet regularly by TCP to keep alive. The interval range is 1-3600 in seconds.	75
Keepalive Retry Times	When TCP heartbeat times out, router will resend heartbeat. After it reaches the preset retry times, TCP connection will be reestablished. The retry times range is 1-16.	9
Packet Size	Set the size of the serial data frame. Packet will be sent out when preset frame size is reached. The size range is 1-1024. The unit is byte.	1024
Serial Frame Interval	The interval that the router sends out real serial data stored in the buffer area to public network. The range is 10-65535, in milliseconds. Note: data will be sent out to public network when real serial data size reaches the preset packet size, even though it's within the serial frame interval.	100

Table 4-4-2-2 DTU Parameters

Item	Description	Default
Transparent		
Protocol	Select "TCP" or "UDP" protocol.	TCP
Keepalive Interval (s)	After TCP client is connected with TCP server, the client will send heartbeat packet by TCP regularly to keep alive. The interval range is 1-3600, in seconds.	75
Keepalive Retry Times	When TCP heartbeat times out, the router will resend heartbeat. After it reaches the preset retry times, router will reconnect to TCP server. The range is 1-16.	9
Packet Size	Set the size of the serial data frame. Packet will be sent out when preset frame size is reached. The range is 1-1024. The unit is byte.	1024
Serial Frame Interval	The interval that the router sends out real serial data stored in the buffer area to public network. The range is 10-65535, in milliseconds. Note: data will be sent out to public network when real serial data size reaches the preset packet size, even though it's within the serial frame interval.	100
Reconnect Interval	After connection failure, router will reconnect to the server at the preset interval, in seconds. The range is 10-60.	10
Specific Protocol	By Specific Protocol, the router will be able to connect to the TCP2COM software.	--
Heartbeat Interval	By Specific Protocol, the router will send heartbeat packet to the server regularly to keep alive. The interval range is 1-3600, in seconds.	30
ID	Define unique ID of each router. No longer than 63 characters without space character.	--
Register String	Define register string for connection with the server.	Null
Server Address	Fill in the TCP or UDP server address (IP/domain name).	Null
Server Port	Fill in the TCP or UDP server port. Range: 1-65535.	Null
Status	Show the connection status between the router and the server.	--
Modbus		
Local Port	Set the router listening port. Range: 1-65535.	502

Table 4-4-2-3 DTU Parameters

Related Configuration Example

[DTU Application Example](#)

4.4.3 Modbus TCP

This section describes how to achieve I/O status via Modbus TCP and Modbus RTU over TCP.

4.4.3.1 Modbus TCP

You can define the address of the DI and DO ports so as to poll DI's status and control DO's status via Modbus TCP protocol.

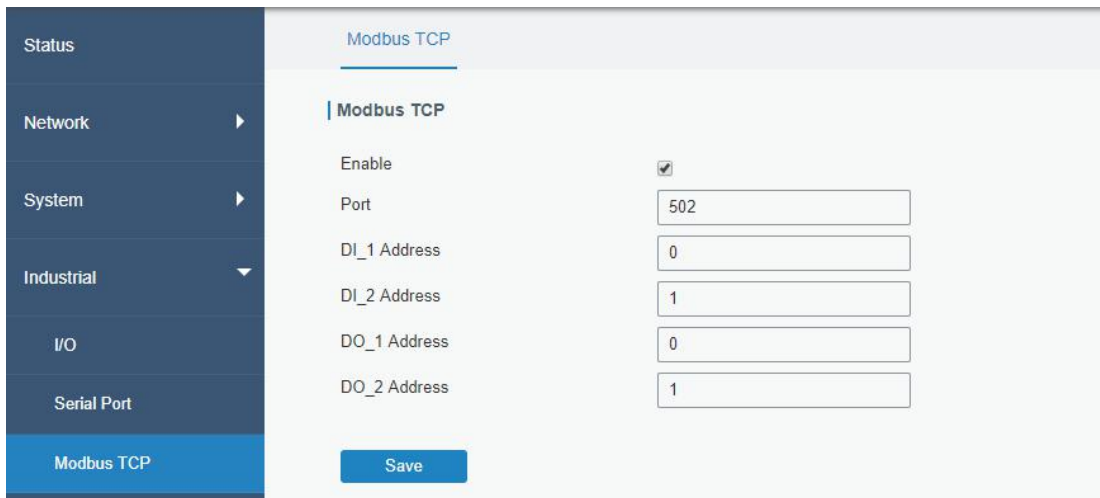

Figure 4-4-3-1

Modbus TCP		
Item	Description	Default
Enable	Enable/disable Modbus TCP.	Disable
Port	Set the router listening port. Range: 1-65535.	502
DI_1 Address	Define the address of DI_1, range: 0-255.	0
DI_2 Address	Define the address of DI_2, range: 0-255.	1
DO_1 Address	Define the address of DO_1, range: 0-255.	0
DO_2 Address	Define the address of DO_2, range: 0-255.	1

Table 4-4-3-1 Modbus TCP Parameters

4.4.4 Modbus Master

UR75 router can be set as Modbus Master to poll the remote Modbus Slave and send alarm according to the response.

4.4.4.1 Modbus Master

You can configure Modbus Master's parameters on this page.

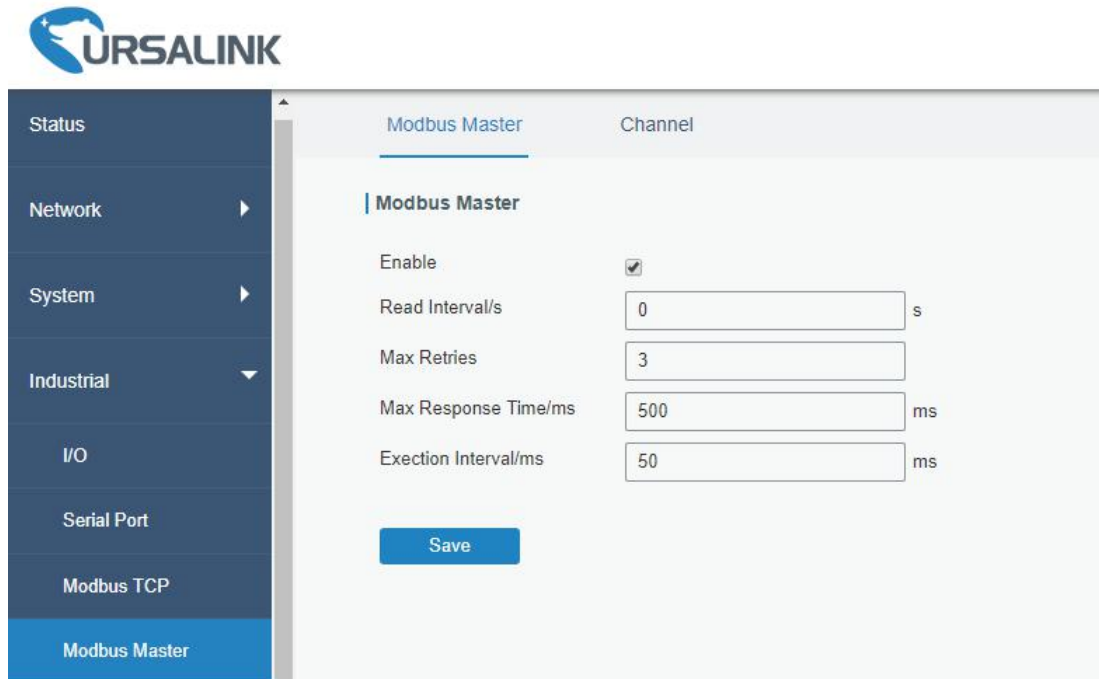

Figure 4-4-4-1

Modbus Master		
Item	Description	Default
Enable	Enable/disable Modbus master.	--
Read Interval/s	Set the interval for reading remote channels. When the read cycle ends, the commands which haven't been sent out will be discard, and the new read cycle begins. If it is set to 0, the device will restart the new read cycle after all channels have been read. Range: 0-600.	0
Max. Retries	Set the maximum retry times after it fails to read, range: 0-5.	3
Max. Response Time/ms	Set the maximum response time that the router waits for the response to the command. If the device does not get a response after the maximum response time, it's determined that the command has timed out. Range: 10-1000.	500
Execution Interval/ms	The execution interval between each command. Range: 10-1000.	50

Table 4-4-4-1

4.4.4.2 Channel

You can add the channels and configure alarm setting on this page, so as to connect the router to the remote Modbus Slave to poll the address on this page and receive alarms from the router in different conditions.

Modbus Master Channel

| Channel Setting

Channel Setting

Name	Slave ID	Address	Number	Type	Type	IP Address	Port	Sign	Operation
test1	1	40	1	Holding Regis	TCP	192.168.23.3	500	<input type="checkbox"/>	<input type="button" value="X"/> <input type="button" value="+"/>

Figure 4-4-4-2

Channel Setting	
Item	Description
Name	Set the name to identify the remote channel. It cannot be blank.
Slave ID	Set Modbus slave ID.
Address	The starting address for reading.
Number	The address number for reading.
Type	Read command, options are "Coil", "Discrete", "Holding Register (INT16)", "Input Register (INT16)", "Holding Register (INT32)" and "Holding Register (Float)".
Link	Select TCP for transportation.
IP address	Fill in the IP address of the remote Modbus device.
Port	Fill in the port of the remote Modbus device.
Sign	To identify whether this channel is signed. Default: Unsigned.

Table 4-4-4-2

Modbus Master
Channel

Alarm Setting

Name

Condition

Max. Threshold

Alarm
 SMS

Phone Group

Normal Content

Note: \$YEAR/\$MON/\$DAY
\$TIME, get NORMAL data
\$VALUE from address
\$ADDRESS of channel
\$NAME. (Abnormal scope is

Abnormal Content

Note: \$YEAR/\$MON/\$DAY
\$TIME, get ABERRANT
data \$VALUE from address
\$ADDRESS of channel
\$NAME. (Abnormal scope is

Continuous Alarm

Figure 4-4-4-3

Alarm Setting	
Item	Description
Name	Set the same name with the channel name to identify the remote channel.
Condition	The condition that triggers alert.
Min. Threshold	Set the min. value to trigger the alert. When the actual value is less than this value, the alarm will be triggered.
Max. Threshold	Set the max. value to trigger the alert. When the actual value is more than this value, the alarm will be triggered.
Alarm	Select the alarm method, e.g SMS.
Operation	
SMS	The preset alarm content will be sent to the specified phone number.
Phone Group	Select the phone group to receive the alarm SMS.
Normal Content	When the actual value is restored to the normal value from exceeding the threshold value, the router will automatically cancel the abnormal alarm and send the preset normal content to the specified phone group.
Abnormal Content	When the actual value exceeds the preset threshold, the router will automatically trigger the alarm and send the preset abnormal content to the specified phone group.
Continuous Alarm	Once it is enabled, the same alarm will be continuously reported. Otherwise, the same alarm will be reported only one time.

Table 4-4-4-3

4.4.5 GPS

This section gives you a detailed introduction to GPS settings, including GPS IP forwarding and GPS serial forwarding.

4.4.5.1 GPS

When you want to receive GPS data, you should enable GPS function on this page.

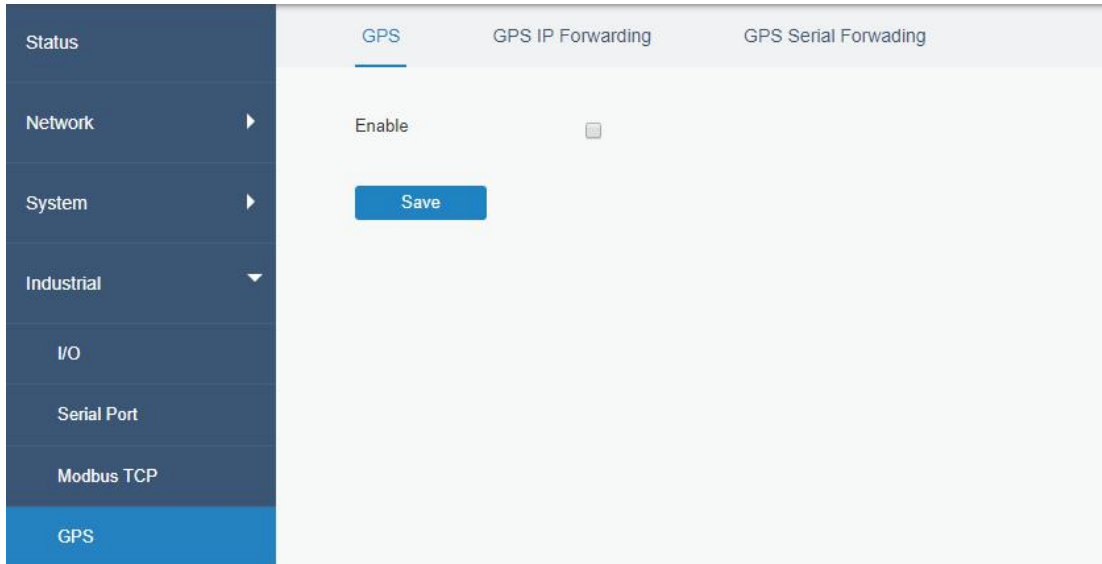

Figure 4-4-5-1

4.4.5.2 GPS IP Forwarding

GPS IP forwarding means that GPS data can be forwarded over the Internet.

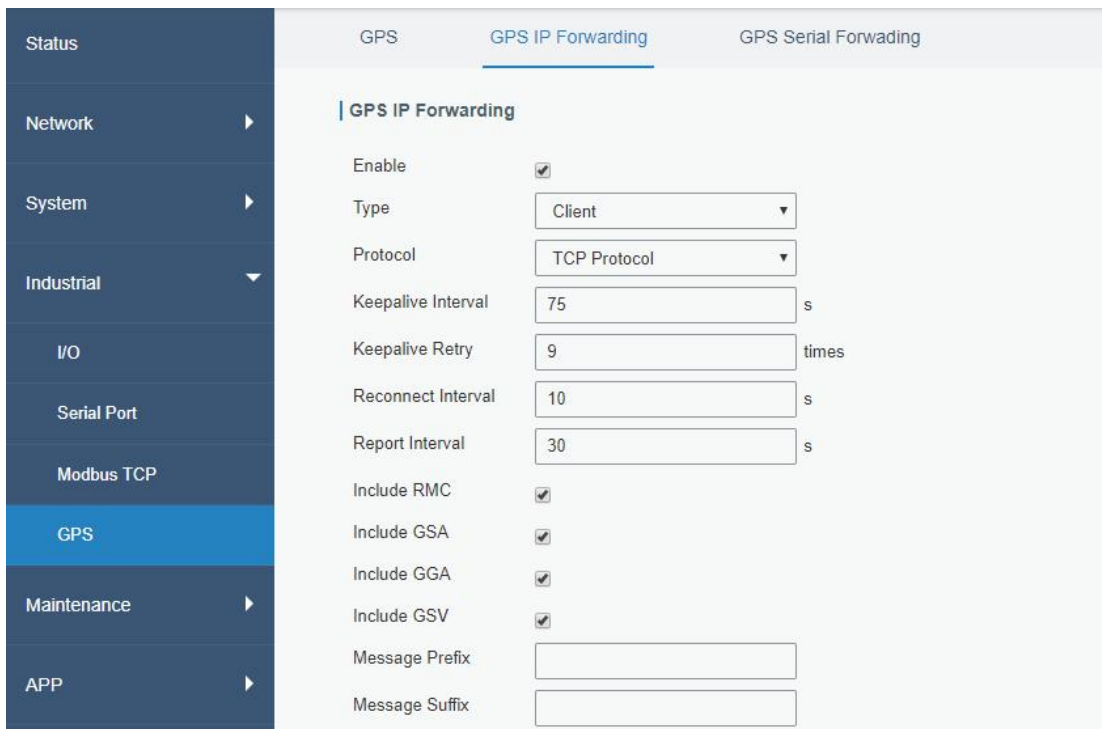

Figure 4-4-5-2

Destination IP Address			
Server Address	Server Port	Status	Operation
			+

Figure 4-4-5-3

GPS IP Forwarding		
Item	Description	Default
Enable	Forward the GPS data to the client or server.	Disable
Type	Select connection type of the router. The options are "Client" and "Server".	Client
Protocol	Select protocol of data transmission. The options are "TCP" and "UDP".	TCP
Keepalive Interval	After it's connected with server/client, the router will send heartbeat packet regularly to the server/client to keep alive. The interval range is 1-3600, in seconds.	75
Keepalive Retry	When TCP heartbeat times out, the router will resend heartbeat. After it reaches the preset retry times, router will reconnect to TCP server. The range is 1-16.	9
Local Port	Set the router listening port. Range: 1-65535.	
Reconnect Interval	After connection failure, router will reconnect to the server at the preset interval, in seconds. The range is 10-60.	10
Report Interval	Router will send GPS data to the server/client at the preset interval, in seconds. The range is 1-60.	30
Include RMC	Whether include RMC in GPS data.	--
Include GSA	Whether include GSA in GPS data.	--
Include GGA	Whether include GGA in GPS data.	--
Include GSV	Whether include GSV in GPS data.	--
Message Prefix	Add a prefix to the GPS data.	Null
Message Suffix	Add a suffix to the GPS data.	Null
Destination IP Address		
Server Address	Fill in the server address to receive GPS data (IP/domain name).	--
Server Port	Fill in the port to receive GPS data. Range: 1-65535.	--
Status	Show the connection status between the router and the server.	--

Table 4-4-5-1 GPS IP Forwarding Parameters

4.4.5.3 GPS Serial Forwarding

GPS IP forwarding means that GPS data can be forwarded to the serial port.

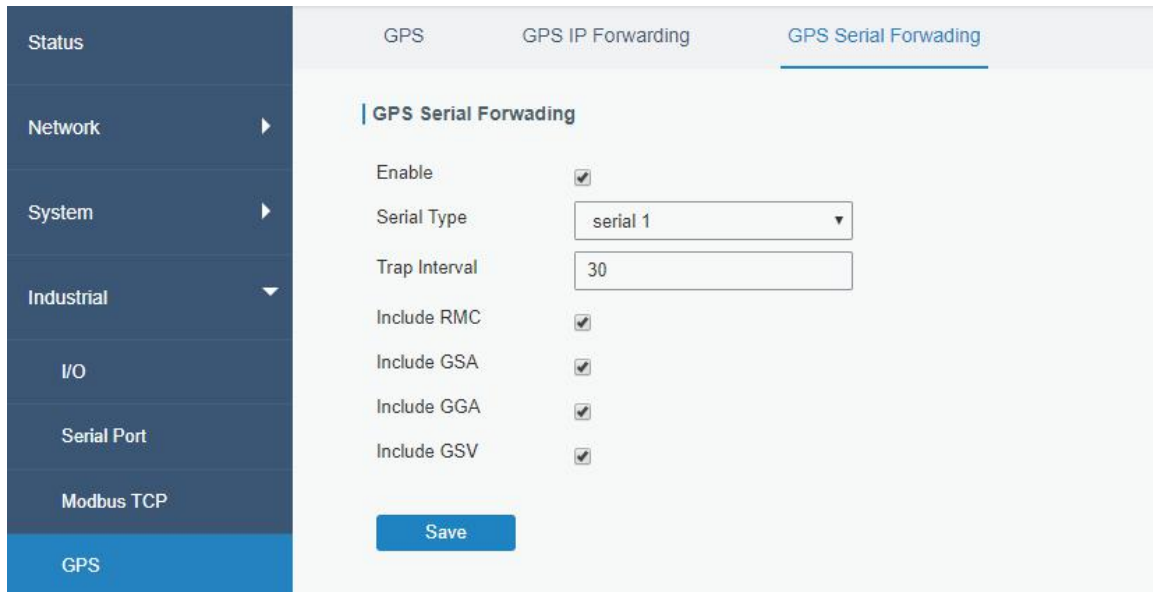

Figure 4-4-5-4

GPS Serial Forwarding		
Item	Description	Default
Enable	Forward the GPS data to the preset serial port.	Disable
Serial Type	Select the serial port to receive GPS data. The options are "serial 1" and "serial 2".	--
Report Interval	Router will forward the GPS data to the serial port at the preset interval, in seconds. The range is 1-60.	30
Include RMC	Whether include RMC in GPS data.	--
Include GSA	Whether include GSA in GPS data.	--
Include GGA	Whether include GGA in GPS data.	--
Include GSV	Whether include GSV in GPS data.	--

Table 4-4-5-2 GPS Serial Forwarding Parameters

4.5 Maintenance

This section describes system maintenance tools and management.

4.5.1 Tools

Troubleshooting tools includes ping and traceroute.

4.5.1.1 Ping

Ping tool is engineered to ping outer network.

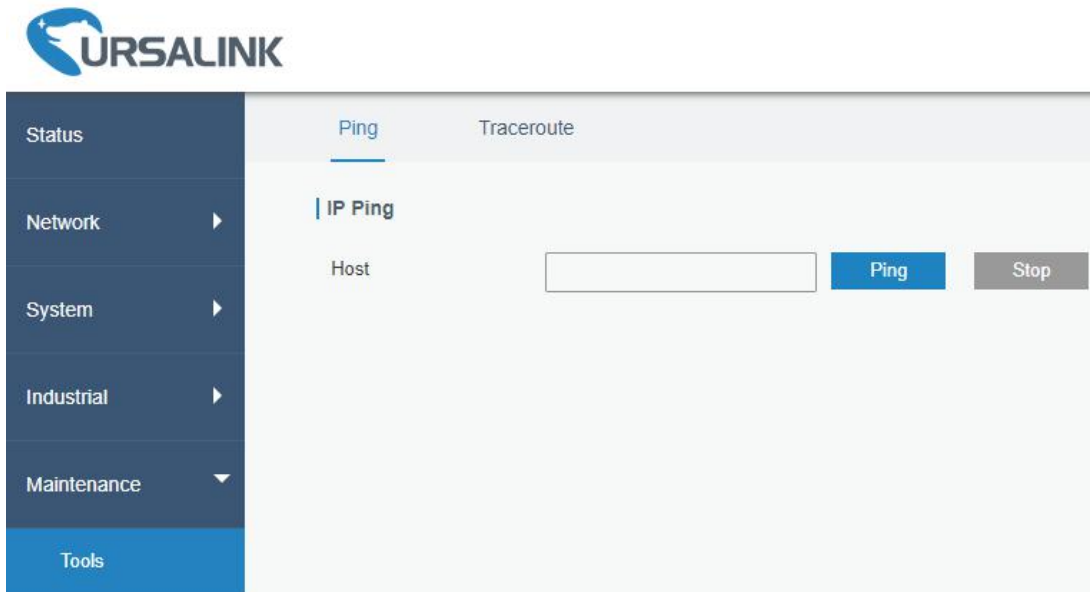

Figure 4-5-1-1

PING	
Item	Description
Host	Ping outer network from the router.

Table 4-5-1-1 IP Ping Parameters

4.5.1.2 Traceroute

Traceroute tool is used for troubleshooting network routing failures.

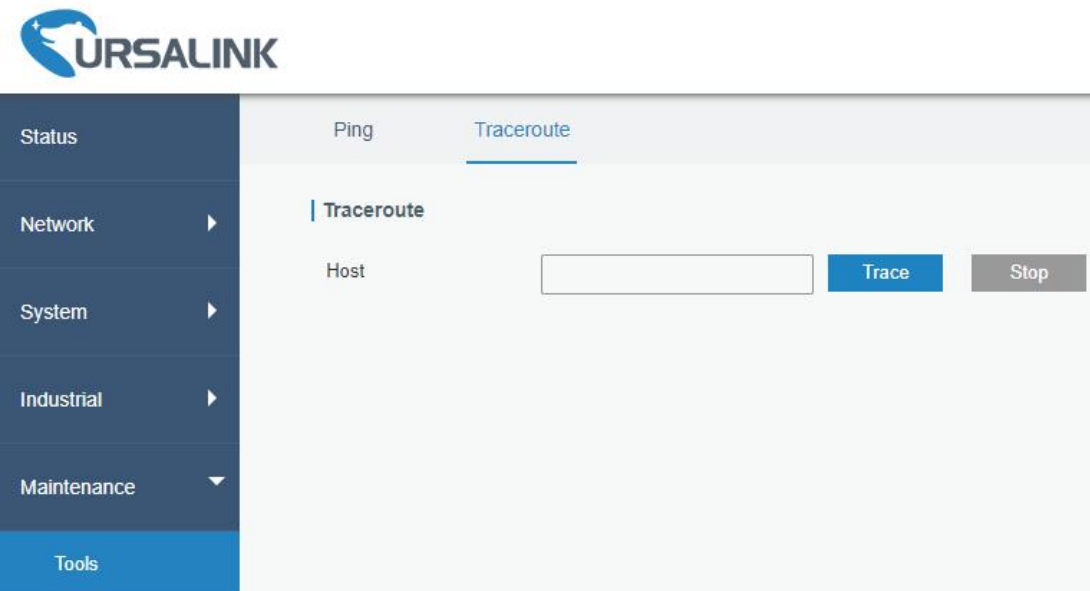

Figure 4-5-1-2

Traceroute	
Item	Description
Host	Address of the destination host to be detected.

Table 4-5-1-2 Traceroute Parameters

4.5.2 Schedule

This section explains how to configure scheduled reboot on the router.

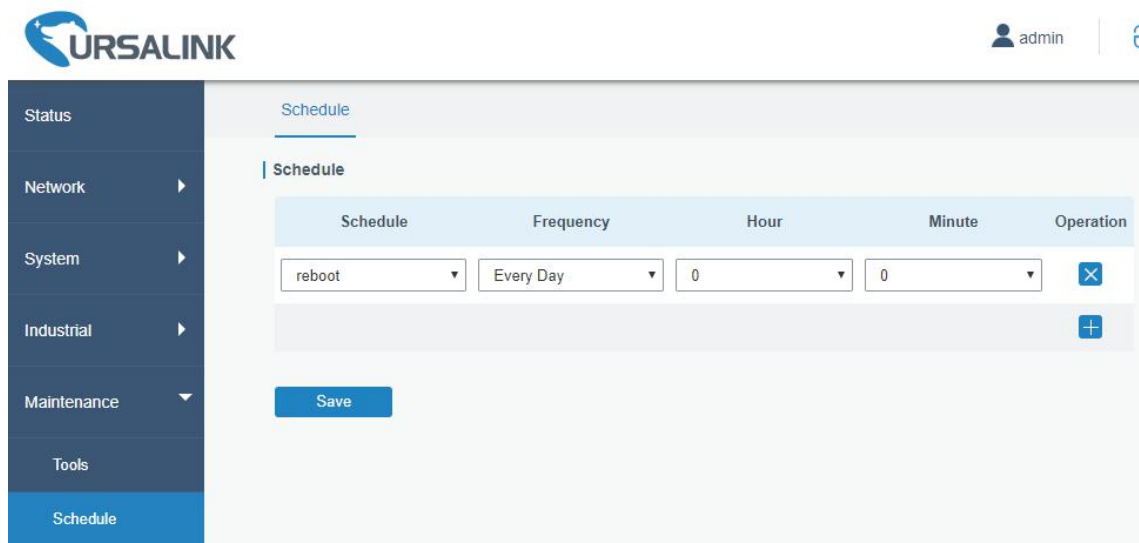

Figure 4-5-2-1

Schedule	
Item	Description
Schedule	Select schedule type.
Reboot	Reboot the router regularly.
Frequency	Select the frequency to execute the schedule.
Hour & Minute	Select the time to execute the schedule.

Table 4-5-2-1 Schedule Parameters

Related Configuration Example

[Schedule Application Example](#)

4.5.3 Log

The system log contains a record of informational, error and warning events that indicates how the system processes. By reviewing the data contained in the log, an administrator or user troubleshooting the system can identify the cause of a problem or whether the system processes are loading successfully. Remote log server is feasible, and router will upload all system logs to remote log server such as Syslog Watcher.

Related Configuration Example

[Logs and Diagnostics](#)

4.5.3.1 System Log

This section describes how to download log file and view the recent log on web.

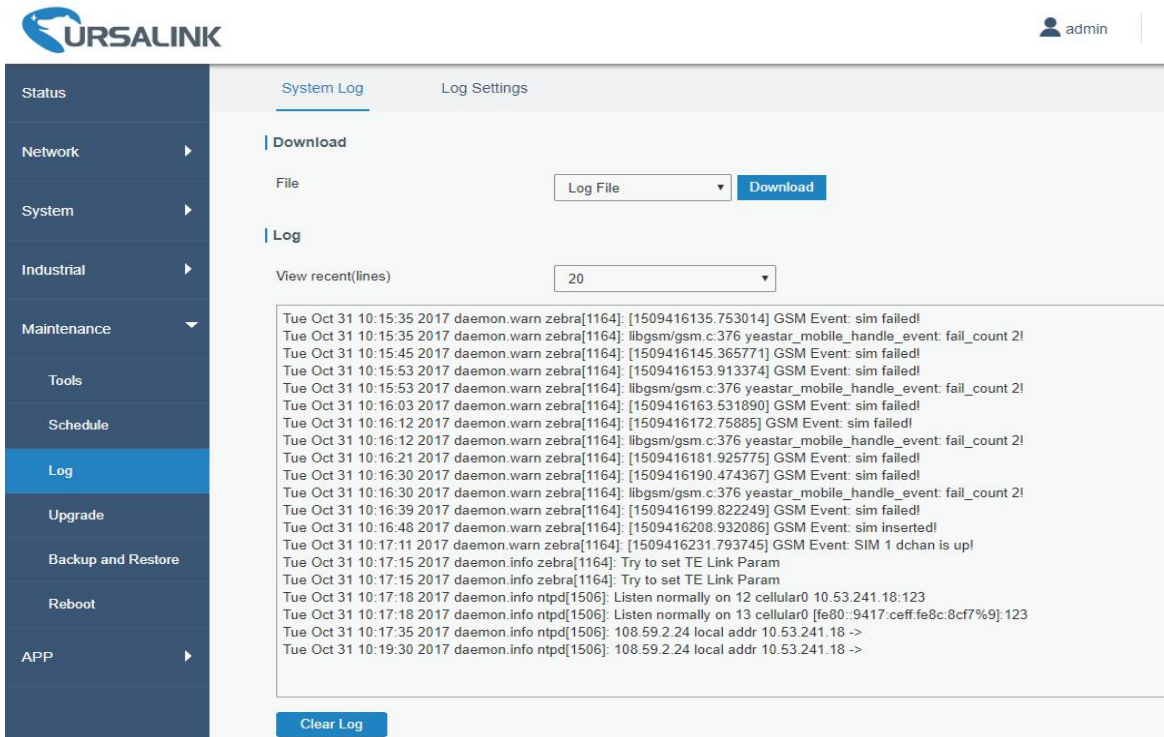

Figure 4-5-3-1

System Log	
Item	Description
Download	Download log file.
View recent (lines)	View the specified lines of system log.
Clear Log	Clear the current system log.

Table 4-5-3-1 System Log Parameter

4.5.3.2 Log Settings

This section explains how to enable remote log server and local log setting.

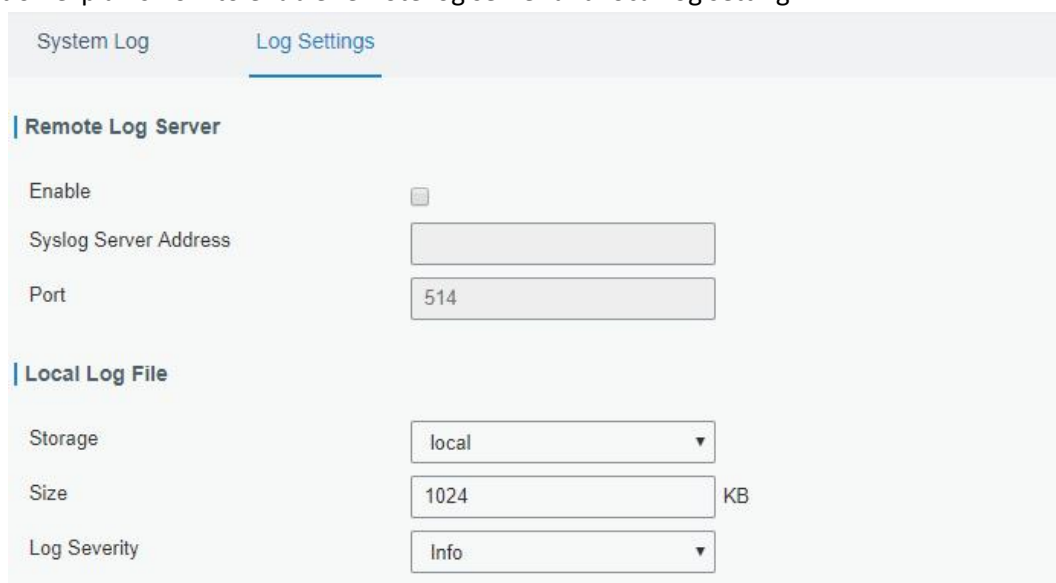

Figure 4-5-3-2

Log Settings	
Item	Description
Remote Log Server	
Enable	With "Remote Log Server" enabled, router will send all system logs to the remote server.
Syslog Server Address	Fill in the remote system log server address (IP/domain name).
Port	Fill in the remote system log server port.
Local Log File	
Storage	User can store the log file in memory or TF card.
Size	Set the size of the log file to be stored.
Log Severity	The list of severities follows the syslog protocol.

Table 4-5-3-2 System Log Parameters

4.5.4 Upgrade

This section describes how to upgrade the router firmware via web. Generally you don't need to do the firmware upgrade.

Note: any operation on web page is not allowed during firmware upgrade, otherwise the upgrade will be interrupted, or even the device will break down.

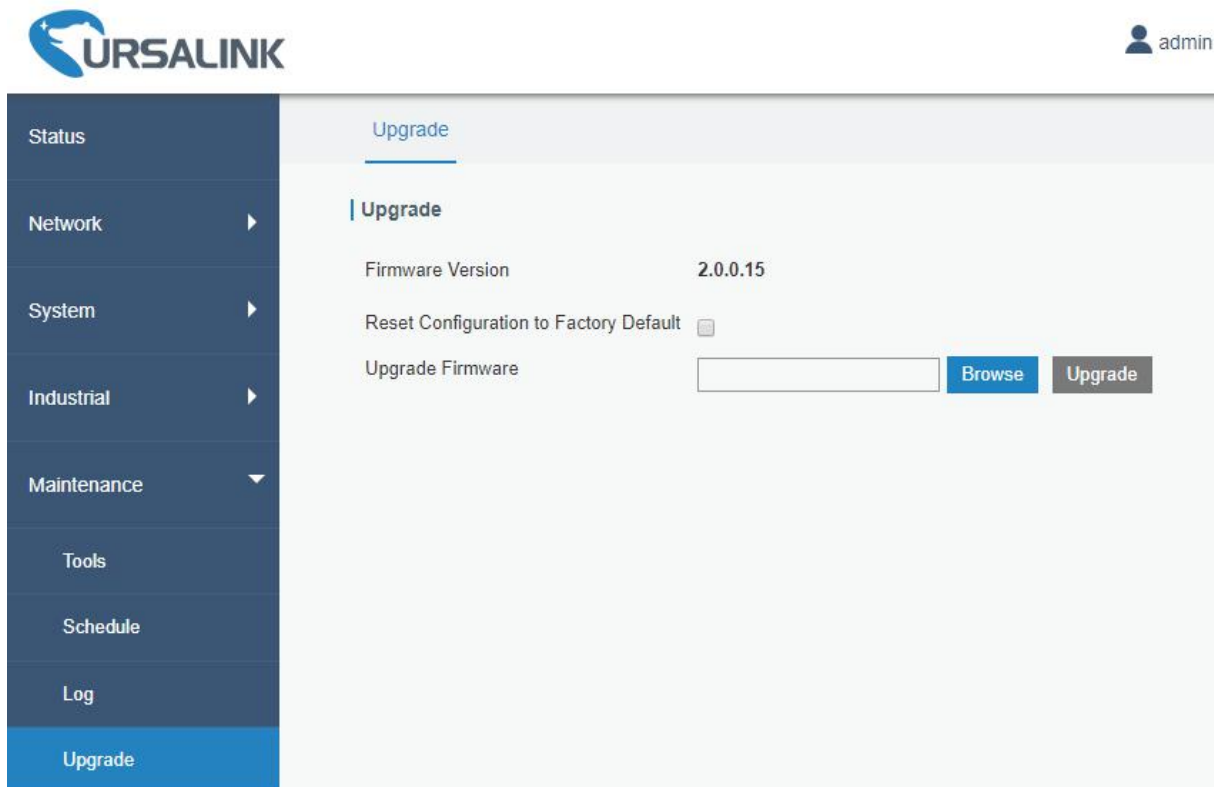

Figure 4-5-4-1

Upgrade	
Item	Description
Firmware Version	Show the current firmware version.
Reset Configuration to Factory Default	When this option is checked, the router will be reset to factory defaults after upgrade.
Upgrade Firmware	Click "Browse" button to select the new firmware file, and click "Upgrade" to upgrade firmware.

Table 4-5-4-1 Upgrade Parameters

Related Configuration Example

[Firmware Upgrade](#)

4.5.5 Backup and Restore

This section explains how to create a complete backup of the system configurations to a file, restore the config file to the router and reset to factory defaults.

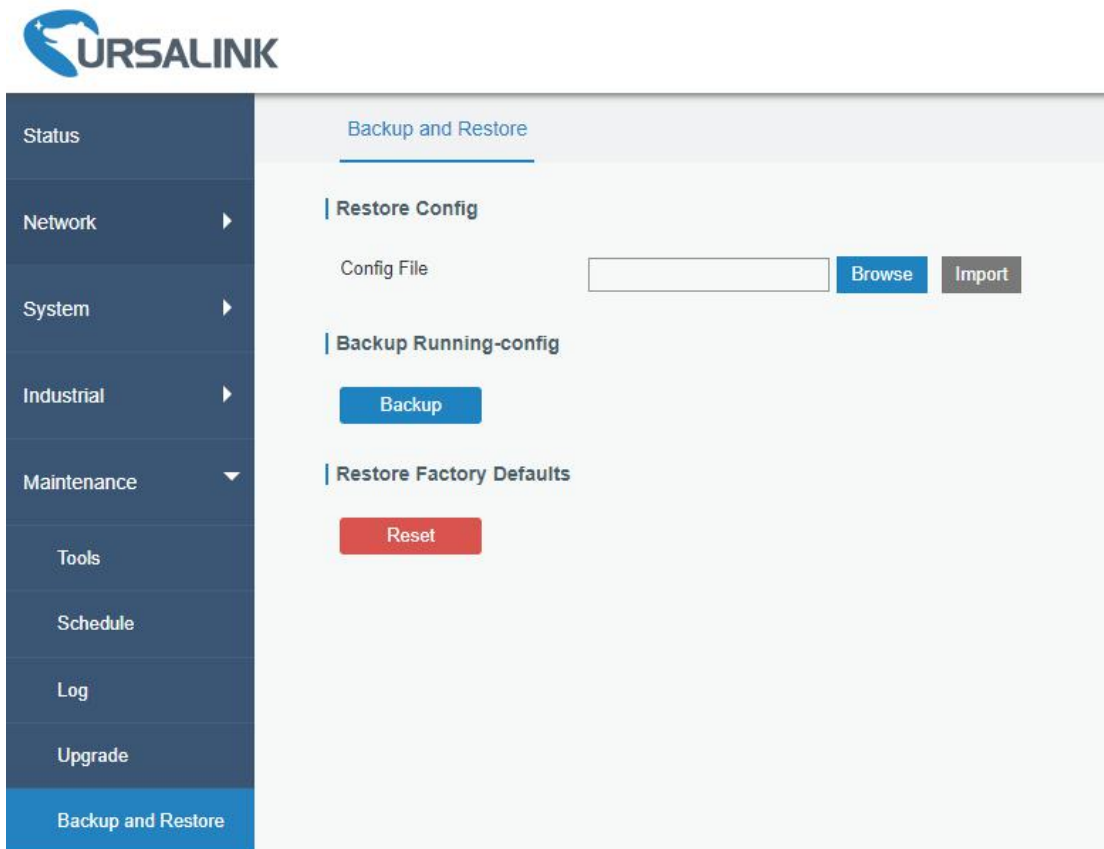

Figure 4-5-5-1

Backup and Restore	
Item	Description
Config File	Click "Browse" button to select configuration file, and then click "Import" button to upload the configuration file to the router.

Backup	Click "Backup" to export the current configuration file to the PC.
Reset	Click "Reset" button to reset factory default settings. Router will restart after reset process is done.

Table 4-5-5-1 Backup and Restore Parameters

Related Configuration Example

[Backup and Restore Configuration](#)

[Restore Factory Defaults](#)

4.5.6 Reboot

On this page you can reboot the router and return to the login page. We strongly recommend clicking "Save" button before rebooting the router so as to avoid losing the new configuration.

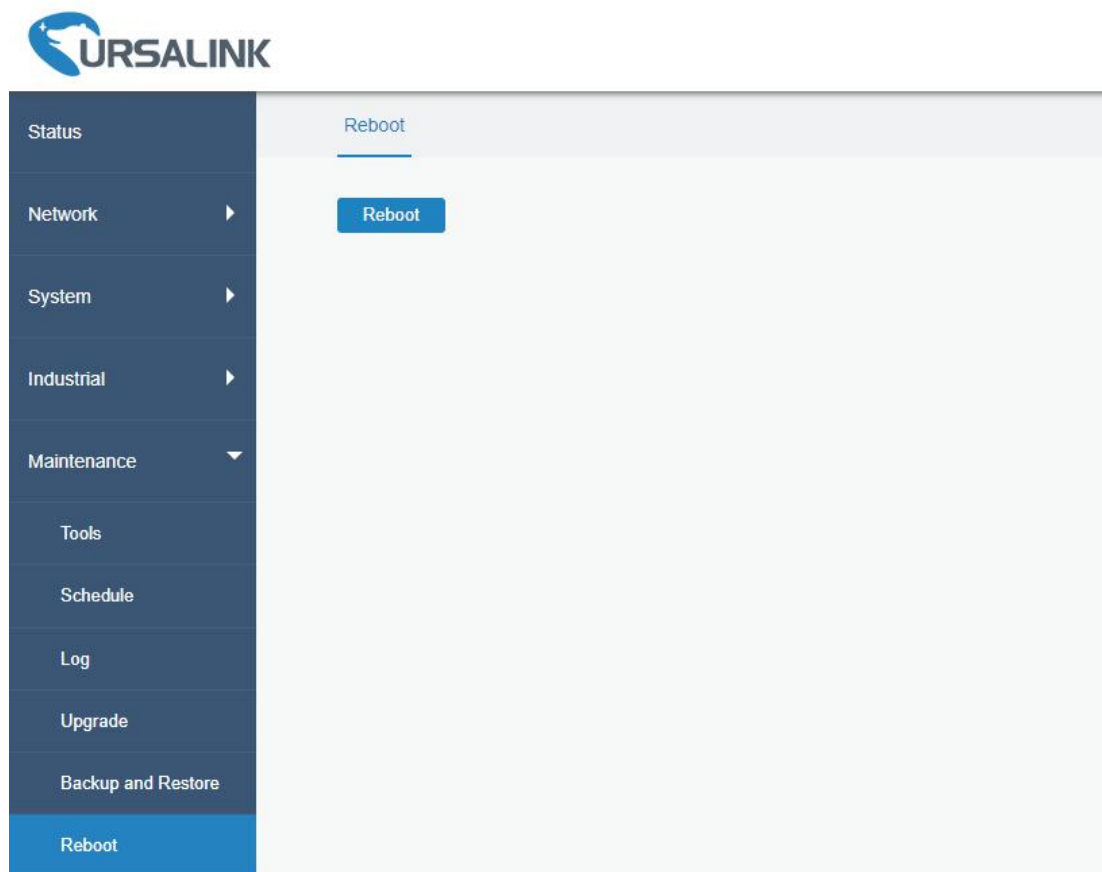

Figure 4-5-6-1

4.6 APP

4.6.1 Python

Python is an object-oriented programming language that has gained popularity because of its clear syntax

and readability.

As an interpreted language, Python has a design philosophy that emphasizes code readability, notably using whitespace indentation to delimit code blocks rather than curly brackets or keywords, and a syntax that allows programmers to express concepts in fewer lines of code than it's used in other languages such as C++ or Java. The language provides constructs and intends to enable writing clear programs on both small and large scale.

Users can use Python to quickly generate the prototype of the program, which can be the final interface of the program, rewrite it with a more appropriate language, and then encapsulate the extended class library that Python can call.

This section describes how to view the relevant running status such as App-manager, SDK version, extended storage, etc. Also you can change the App-manager configuration, and import the Python App package from here.

4.6.1.1 Python

Micro SD card/SSD must be installed for Python App.

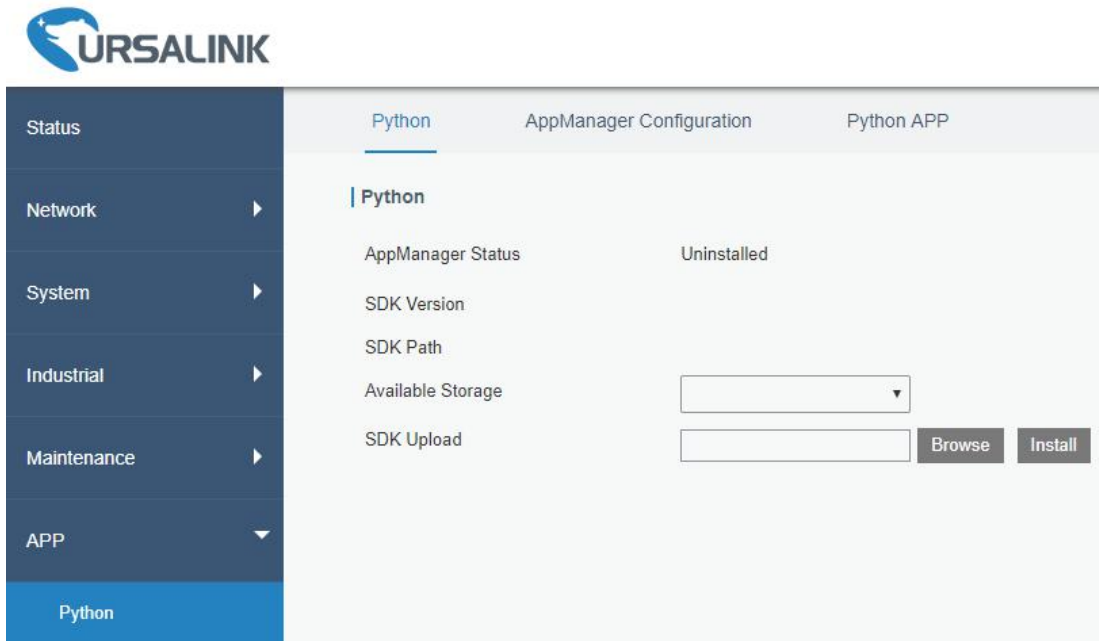

Figure 4-6-1-1

Python	
Item	Description
AppManager Status	Show AppManager's running status, like "Uninstalled", "Running" or "Stopped".
SDK Version	Show the version of the installed SDK.
SDK Path	Show the SDK installation path.
Available Storage	Select available storage such as Micro SD or SSD to install SDK.
SDK Upload	Upload and install SDK for Python.
Uninstall	Uninstall SDK.
View	View application status managed by AppManager.

Table 4-6-1-1 Python Parameters

4.6.1.2 App Manager Configuration

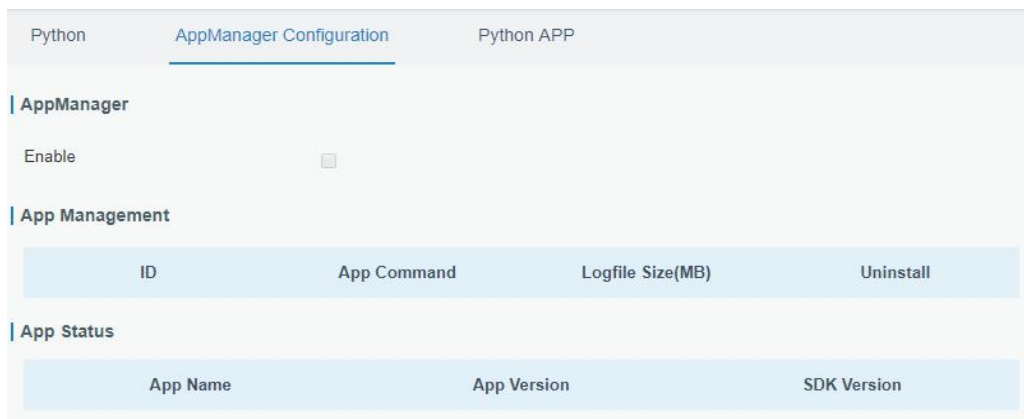

Figure 4-6-1-2

AppManager Configuration	
Item	Description
Enable	After enabling Python AppManager, user can click "View" button on the "Python" webpage to view the application status managed by AppManager.
App Management	
ID	Show the ID of the imported App.
App Command	Show the name of the imported App.
Logfile Size(MB)	User-defined Logfile size. Range: 1-50.
Uninstall	Uninstall APP.
App Status	
App Name	Show the name of the imported App.
App Version	Show the version of the imported App.
SDK Version	Show the SDK version which the imported App is based on.

Table 4-6-1-2 APP Manager Parameters

4.6.1.3 Python App

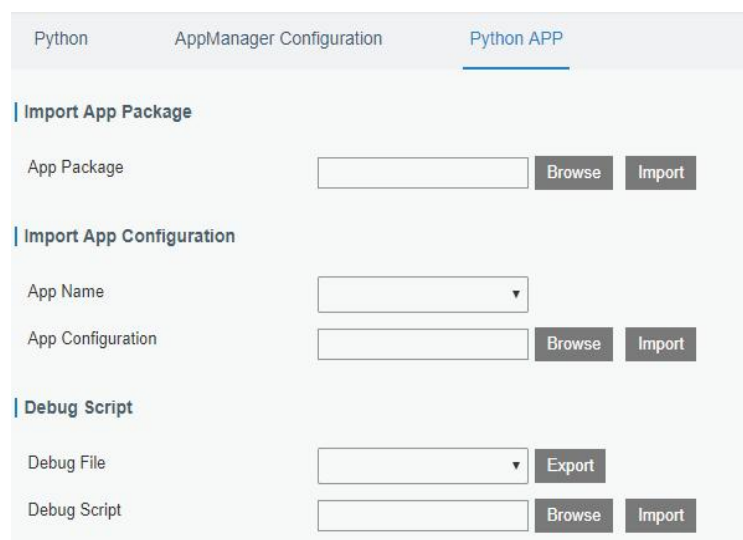

Figure 4-6-1-3

Python APP	
Item	Description
App Package	Select App package and import.
App Name	Select App to import configuration.
App Configuration	Select configuration file and import.
Debug File	Export script file.
Debug Script	Select Python script to be debugged and import.

Table 4-6-1-3 APP Parameters

Chapter 5 Application Examples

5.1 Account Info Management

It is strongly recommended that you change the default username and password of the administrator account when you log in Ursalink Router’s WEB GUI page at first time for the sake of security.

Example: change the username and password of administrator account to “uradmin” and “URpassword”.

The configuration procedures are listed as below.

1. Go to “System > General Settings > Account”.
2. Modify the username to “uradmin”, fill in the old Password “password”, and set the new Password “URpassword”.

Click “Save” button, and then you will be asked to login again with the new username and password.

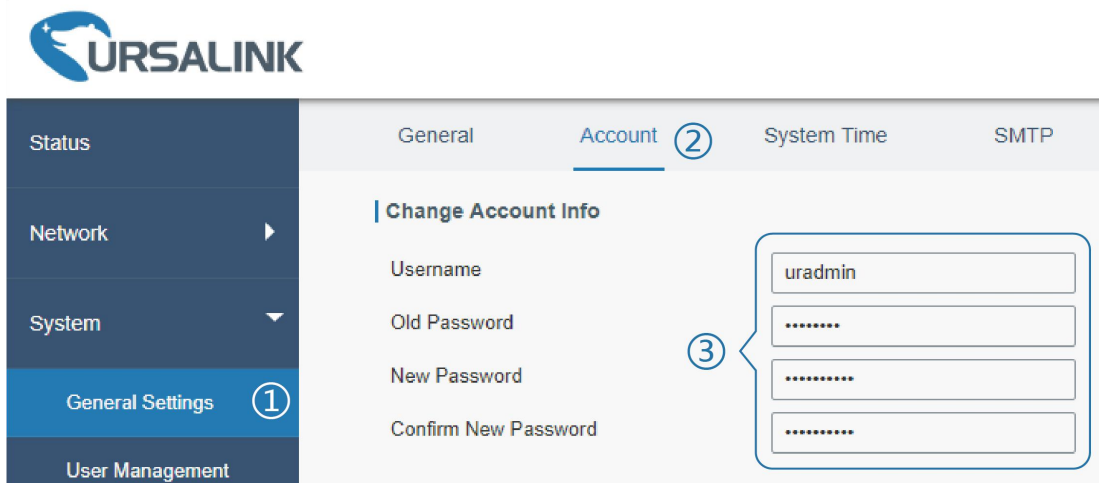

Related Topic

[Account Management](#)

5.2 Common User Management

The UR75 router is capable of creating up to 5 common user accounts that have different authorities, including “Read-Only” and “Read-Write” to manage the router.

“Read-Only” refers to the authority that user is only allowed to view the configuration;

“Read-Write” refers to the authority that user can view and modify all the parameters.

Example: create 2 common user accounts listed below.

Username	Password	Permission
ur_user1	UR_password1	Read-Only
ur_user2	UR_password2	Read-Write

Configuration procedures are listed as blow.

1. Go to “System > User Management > User Management”.
2. Click “+” to add a new common user.
3. Set “Username”, “Password”, and “Permission” as below.

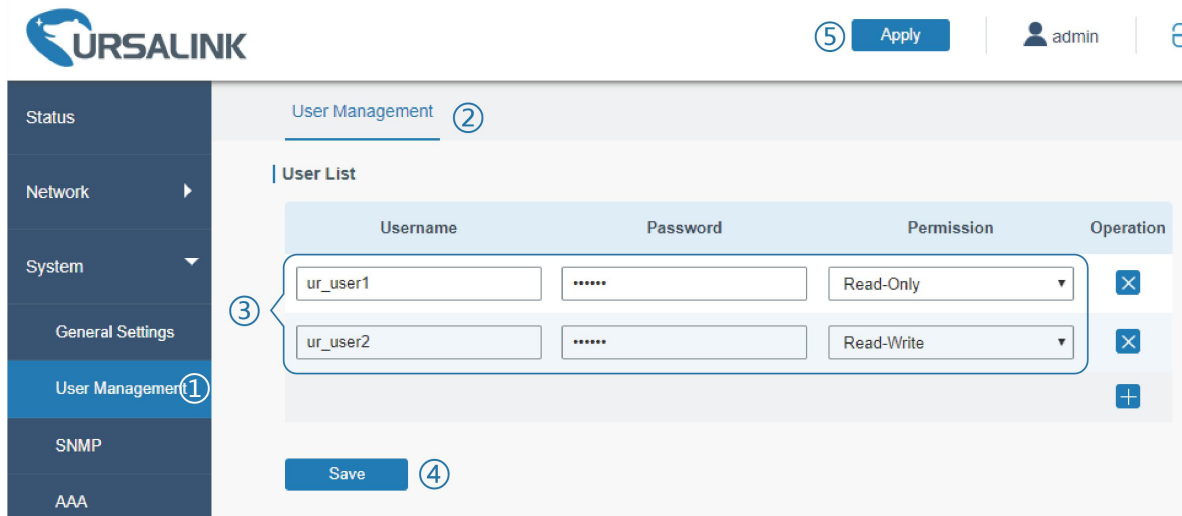

Click “Save” button, and then click “Apply” on the top-right corner to make the changes take effect.

Related Topic

[User Management](#)

5.3 System Time Management

There are 3 ways to synchronize the system time: “Sync with Browser”, “Set up Manually”, and “Sync with NTP Server”.

Note: to ensure that the router runs with correct time, it’s recommended that you set the system time when you configure the router.

In the following part we take UTC+8 time zone as an example.

A. Synchronize time with browser

Go to “System > General Settings > System Time”, set time zone as “8 China (Beijing)” and Sync Type as “Sync with Browser”. And Click “Save” button.



B. Set up time by manual

1. Go to “System > General Settings > System Time”, set time zone as “8 China (Beijing)” and Sync Type as “Set up Manually”.
2. Select the correct local time. And click “Save” button.

The screenshot shows the 'System Time Settings' interface. At the top, it displays the 'Current Time' as '2017-11-09 09:18:16 Thur'. Below this, there are four rows of settings: 'Time Zone' is set to '8 China (Beijing)', 'Sync Type' is set to 'Set up Manually', 'Date' is '2017-11-09', and 'Time' is set to '9:19:04'. A blue 'Save' button is located at the bottom left. Three numbered callouts are present: (1) points to the 'Time Zone' and 'Sync Type' dropdowns, (2) points to the 'Date' field, and (3) points to the 'Save' button.

C. Synchronize time with NTP server

1. Go to “System > General Settings > System Time”, set time zone as “8 China (Beijing)” and Sync Type as “Sync with NTP Server”.
2. Configure an available NTP server address such as “time.windows.com”. Click “Save” button.

The screenshot shows the 'System Time Settings' interface. At the top, it displays the 'Current Time' as '2017-11-09 09:19:27 Thur'. Below this, there are five rows of settings: 'Time Zone' is set to '8 China (Beijing)', 'Sync Type' is set to 'Sync with NTP Server', 'NTP Server Address' is 'time.windows.com', and 'Enable NTP Server' is an unchecked checkbox. A blue 'Save' button is located at the bottom left. Three numbered callouts are present: (1) points to the 'Time Zone' and 'Sync Type' dropdowns, (2) points to the 'NTP Server Address' field, and (3) points to the 'Save' button.

Related Topic

[System Time Setting](#)

5.4 Backup and Restore Configuration

A. Backup Configuration

1. Go to “Maintenance > Backup and Restore > Backup and Restore”.
2. Click “Backup” button under “Backup running-config”.

Then the current configuration file will be downloaded to the “Downloads” folder of the PC.

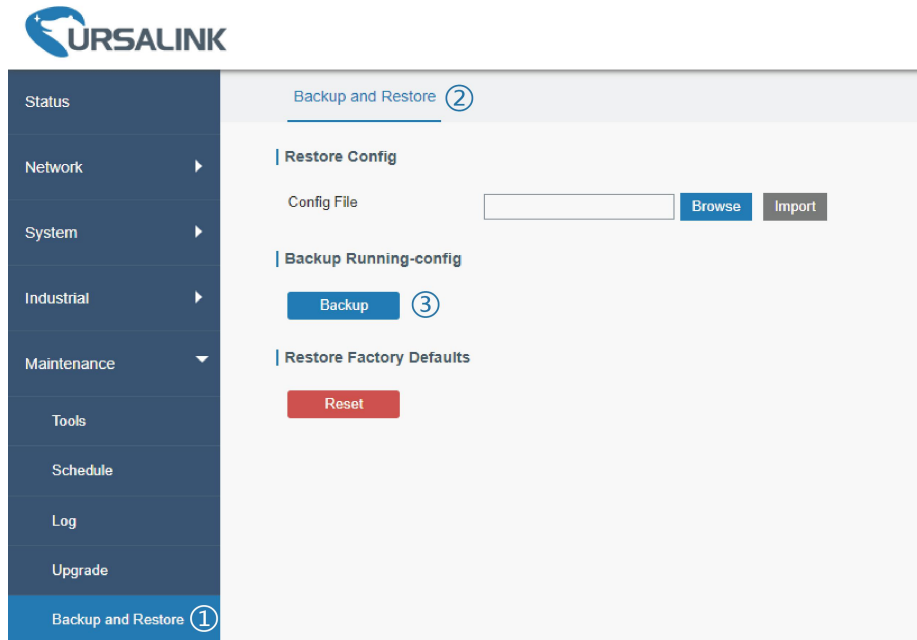

B. Restore Configuration

1. Go to “Maintenance > Backup and Restore > Backup and Restore”.
2. Click “Browse” button under the “Restore” to select configuration file from PC.
3. Click “Import” to import the selected configuration file to the router.

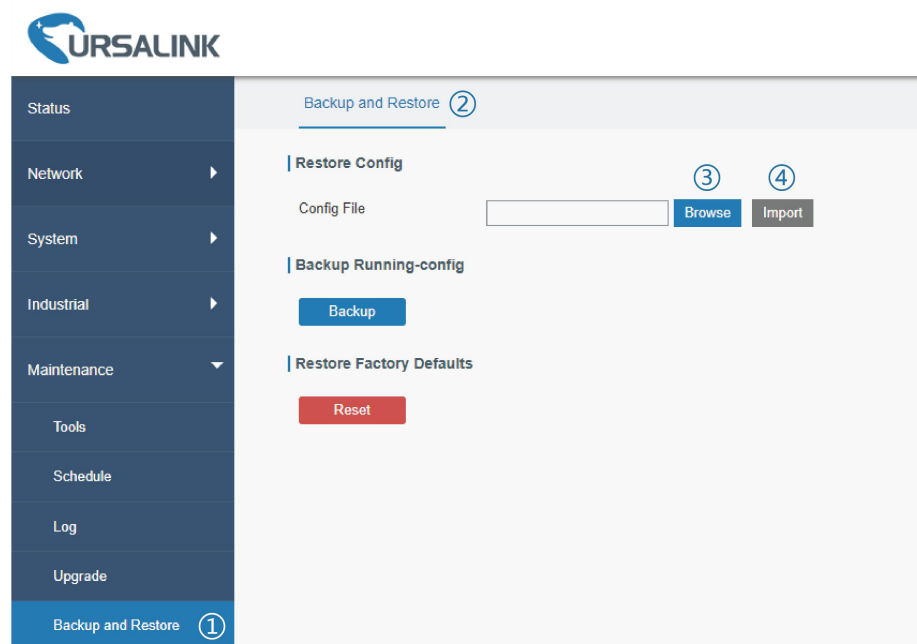

Related Topic

[Backup and Restore](#)

5.5 Restore Factory Defaults

5.5.1 Via Web Interface

1. Log in web interface, and go to “Maintenance > Backup and Restore”.
2. Click “Reset” button under the “Restore Factory Defaults”.

You will be asked to confirm if you'd like to reset it to factory defaults. Then click “Reset” button.

The screenshot displays the URSALINK web interface. On the left is a navigation menu with items: Status, Network, System, Industrial, Maintenance, Tools, Schedule, Log, Upgrade, and Backup and Restore (marked with a circled '1'). The main content area is titled 'Backup and Restore' (marked with a circled '2') and contains three sections: 'Restore Config' with a 'Config File' input field and 'Browse'/'Import' buttons; 'Backup Running-config' with a 'Backup' button; and 'Restore Factory Defaults' with a 'Reset' button (marked with a circled '3'). A confirmation dialog box is overlaid on the 'Restore Factory Defaults' section, containing the text: 'Reset operation will erase all configuration data on Router and reset the system to factory defaults. Continue?'. The dialog has 'Reset' and 'Cancel' buttons, with a blue arrow pointing to the 'Reset' button.

Then the router will reboot and restore to factory settings immediately.

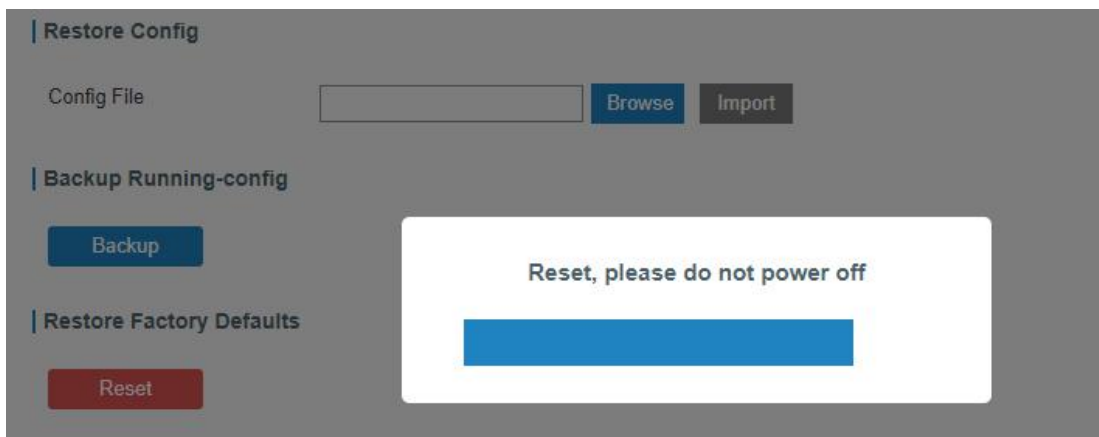

Please wait till the login page pops up again, which means the router has already been reset to factory defaults successfully.

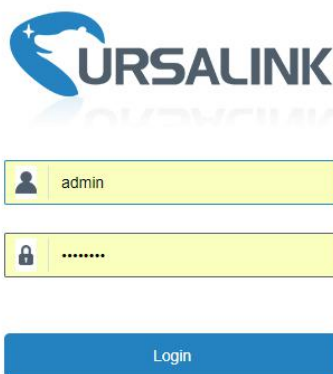

Related Topic

[Restore Factory Defaults](#)

5.5.2 Via Hardware



Locate the reset button on the router, and take corresponding actions based on the status of STATS LED.

STATUS LED	Action
Blinking	Press and hold the reset button for more than 15 seconds.
Static Green → Rapidly Blinking	Release the button and wait.
Off → Blinking	The router is now reset to factory defaults.

5.6 Firmware Upgrade

It is suggested that you contact Ursalink technical support first before you upgrade router firmware. After getting firmware file from Ursalink technical support, please refer to the following steps to complete the upgrade.

1. Go to “Maintenance > Upgrade”.
2. Click “Browse” and select the correct firmware file from the PC.
3. Click “Upgrade” and the router will check if the firmware file is correct. If it’s correct, the firmware will be imported to the router, and then the router will start to upgrade.

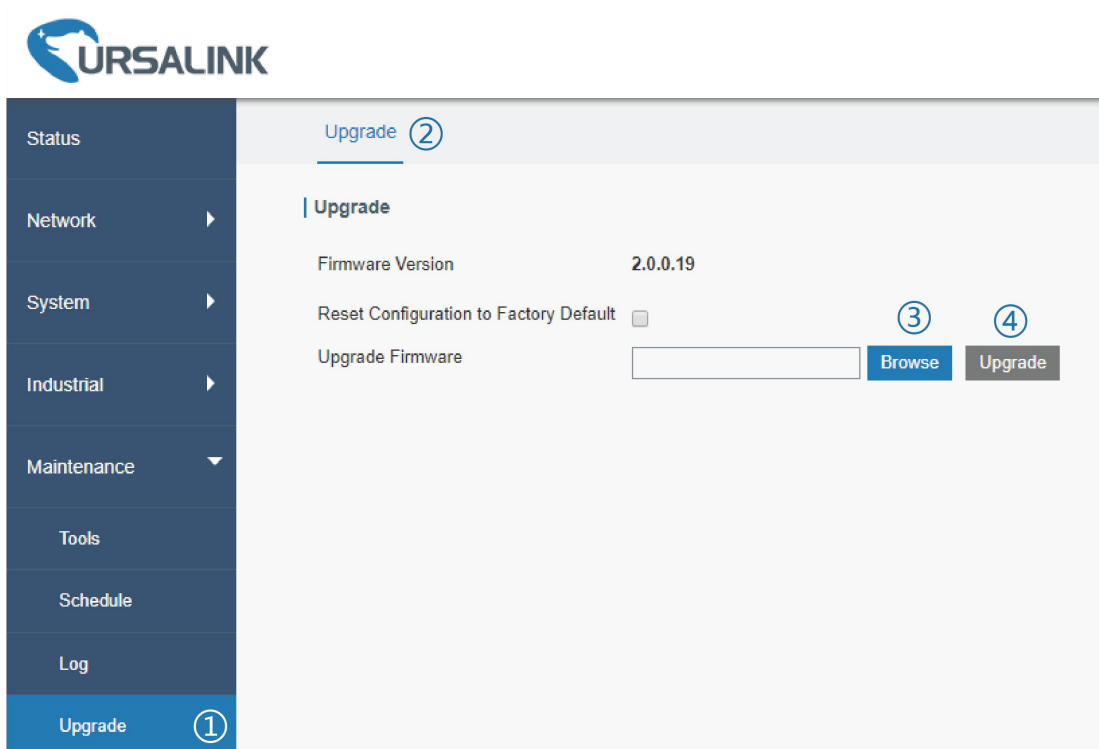

URSALINK

Status | Upgrade

Network | System | Industrial | Maintenance | Tools | Schedule | Log | Upgrade

Upgrade

Firmware Version: 2.0.0.19

Reset Configuration to Factory Default:

Upgrade Firmware:

Importing firmware. Please stay on this page till upgrade is finished.

URSALINK

Status | Upgrade

Network | System | Industrial | Maintenance | Tools | Schedule | Log | Upgrade

Upgrade

Firmware Version: 2.0.0.19

Reset Configuration to Factory Default:

Upgrade Firmware:

Importing firmware. Please stay on this page till upgrade is finished.

Please keep the power on during upgrade.

Related Topic

[Upgrade](#)

5.7 Events Application Example

Example

In this section, we will take an example of sending alarm messages by email when the following events occur and recording the event alarms on the Web GUI.

Events	Actions to make events occur (for test)
Cellular network is connected.	Insert SIM card.
Cellular network is disconnected.	Remove SIM card.
WAN cable is connected.	Plug WAN cable.
WAN cable is disconnected.	Unplug WAN cable.

Configuration Steps

1. Go to “System > Events > Events Settings” and enable Event settings.
2. Check corresponding events for record and email alarm, and then click “Save” button as below. Click “Email Settings” and go to SMTP settings.

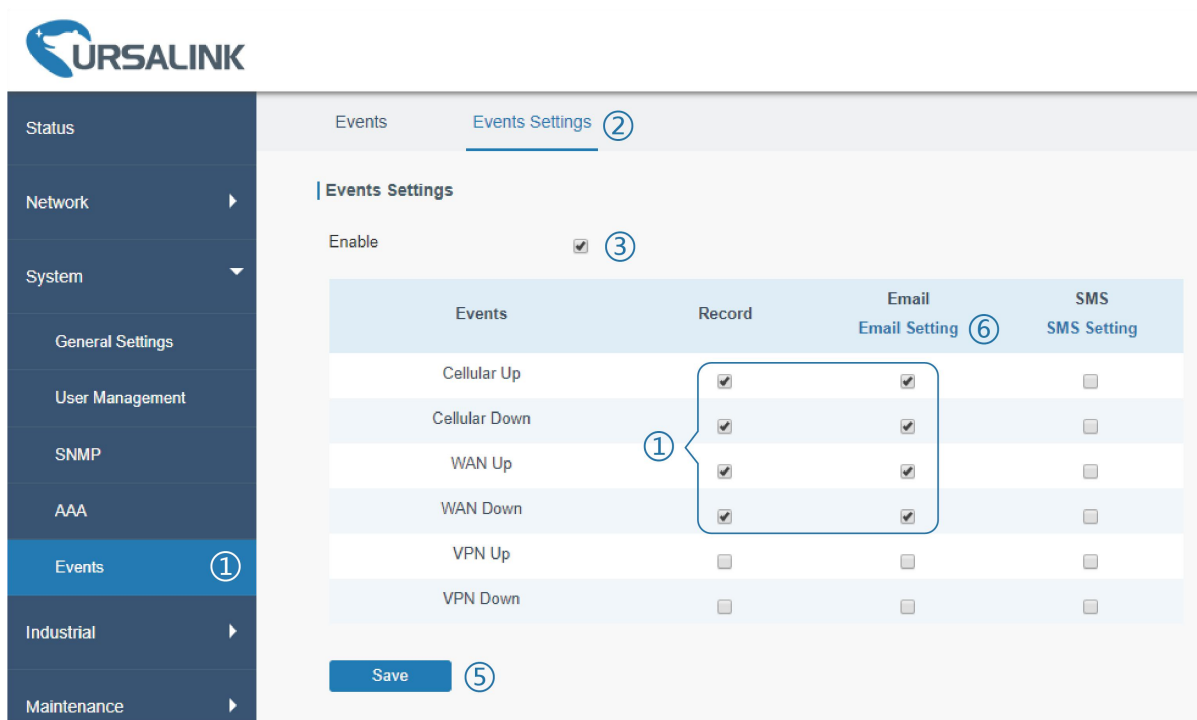

3. Configure the corresponding parameters including email sending settings and recipients as below. Click “Save” and “Apply” button to make the changes take effect.

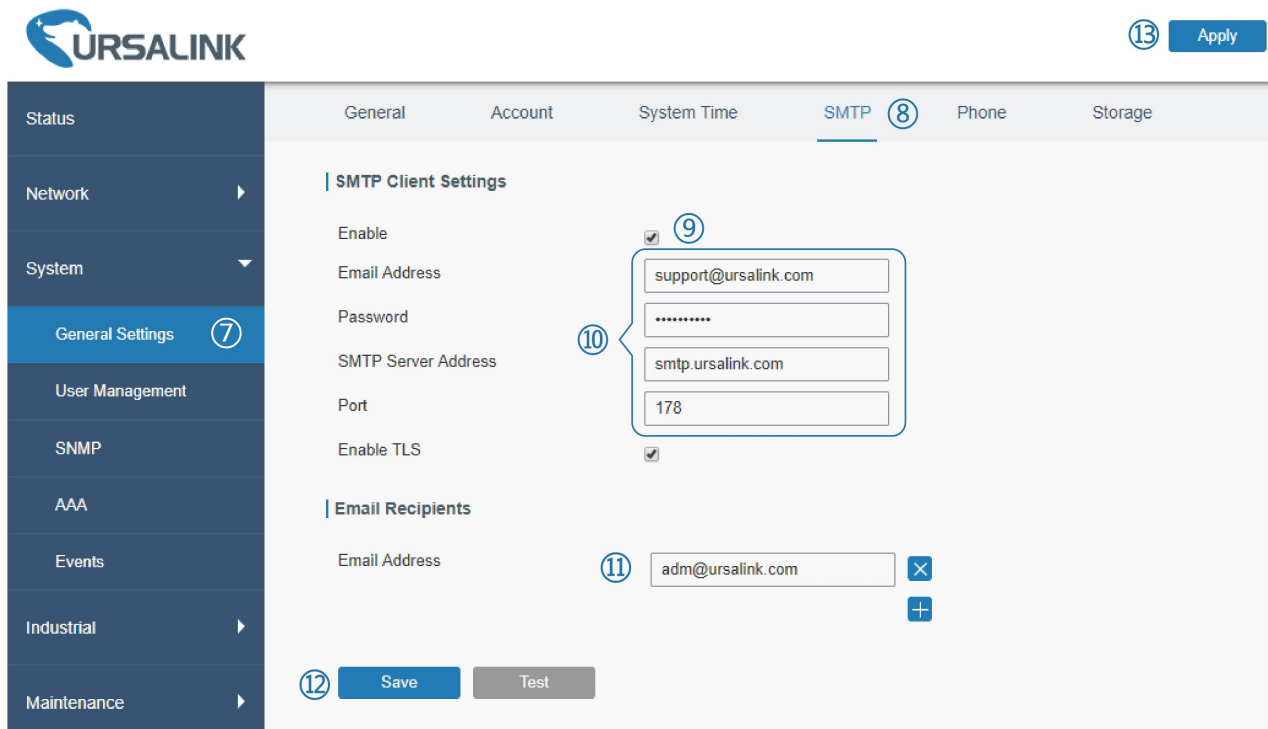

- To test the functionality of Alarm, please take the corresponding actions listed above. It will send an alarm e-mail to you when the relevant event occurs. Refresh the web GUI, go to “Events > Events”, and you will find the events records.

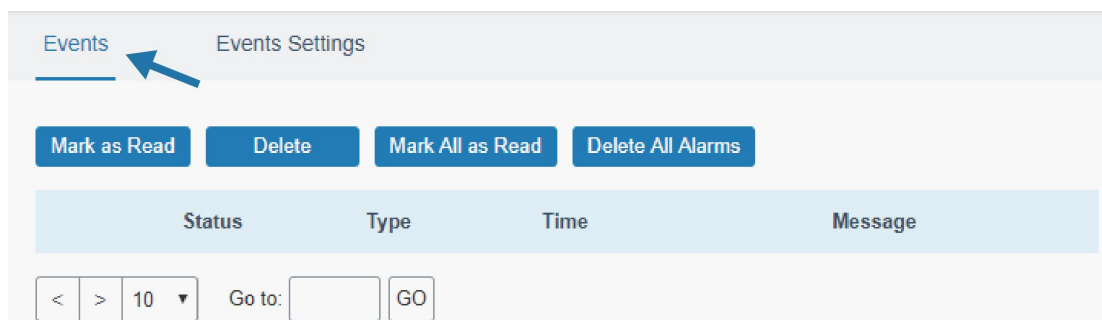

Related Topics

[Events](#)

[Email Setting](#)

5.8 Schedule Application Example

Through schedule configuration, the UR75 can be set to reboot at preset time every day.

Example

Configure router to reboot at 0:00 every day.

Configuration Steps

- Go to “Maintenance > Schedule > Schedule”.

2. Click “+” to set up a new schedule task as below.
3. Click “Save” and “Apply” button.

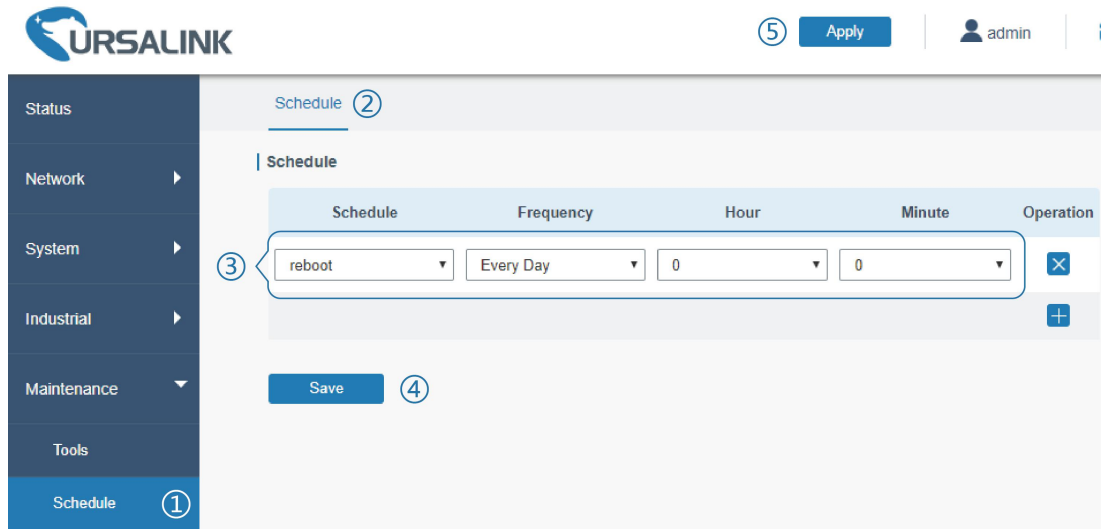

Related Topic

[Schedule Setting](#)

5.9 Logs and Diagnostics

System log of the UR75 supports 3 types of output method, including Web and Remote Log Server.

Application 1

Obtain system log on Web.

Go to “Maintenance > Log > System log”, and you will see the log is listed in the box.

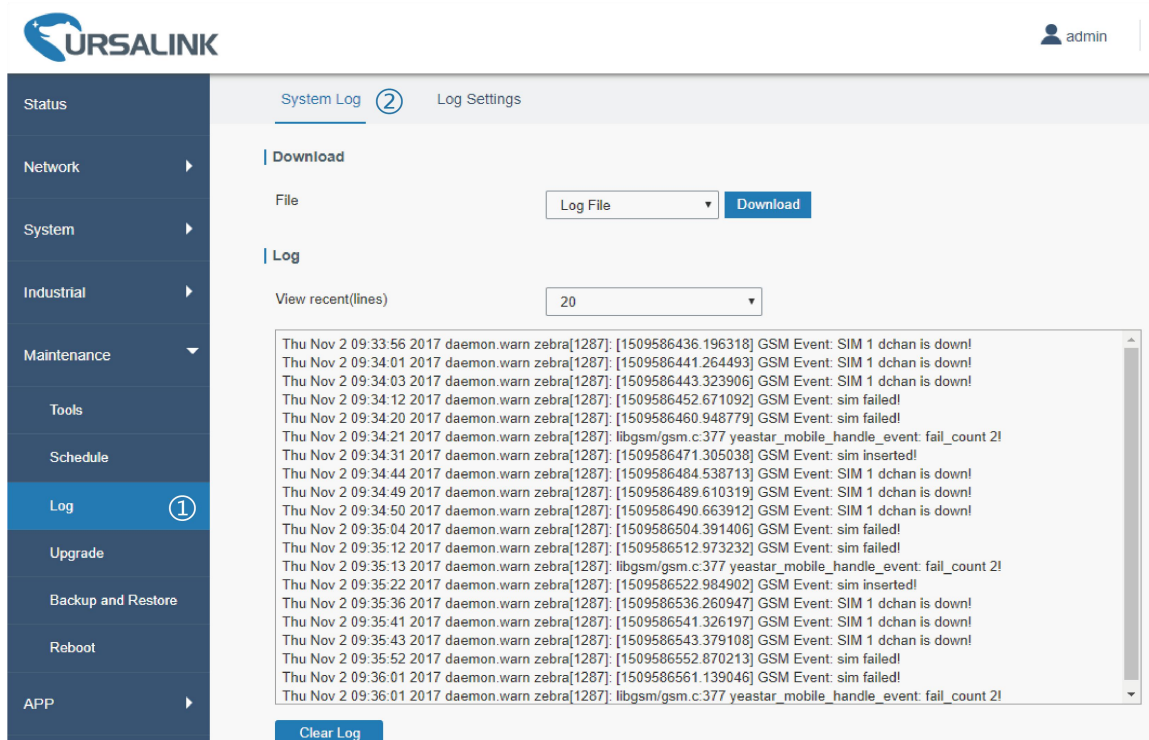

Application 2

Send the system log to the remote syslog server.

Server IP: 110.22.14.43; Port: 514

Go to “Maintenance > Log > Log Settings” to configure the parameters as below.

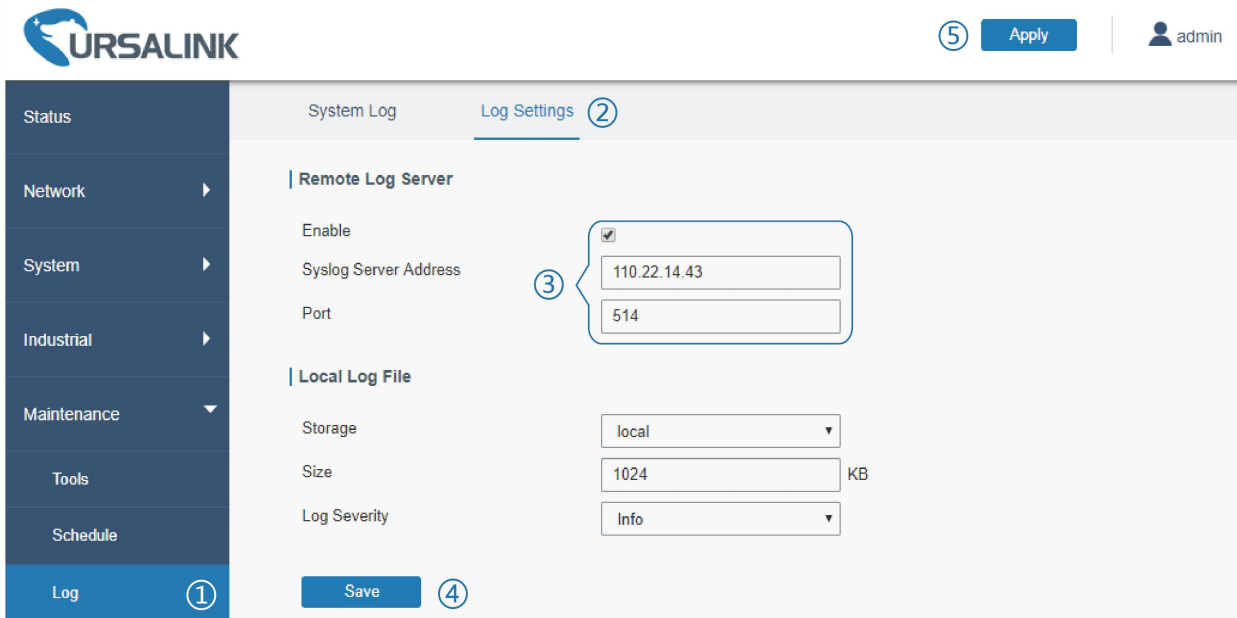

Then click “Save” and “Apply” button.

Related Topic

[System Log](#)

5.10 SNMP Application Example

Before you configure SNMP parameters, please download the relevant “MIB” file from the UR75’s WEB GUI first, and then upload it to any software or tool which supports standard SNMP protocol. Here we take “ManageEngine MibBrowser Free Tool” as an example to access the router to query cellular information.

1. Go to “System > SNMP > MIB” and download the MIB file “URSA-ROUTER-MIB.txt” to PC.

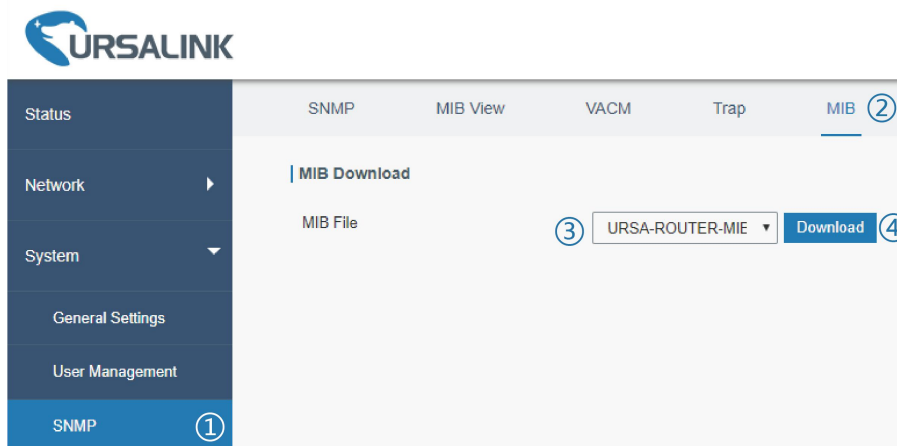

2. Start “ManageEngine MibBrowser Free Tool” on the PC. Click “File > Load MIB” on the menu bar. Then select “BURSA-ROUTER-MIB.txt” file from PC and upload it to the software.

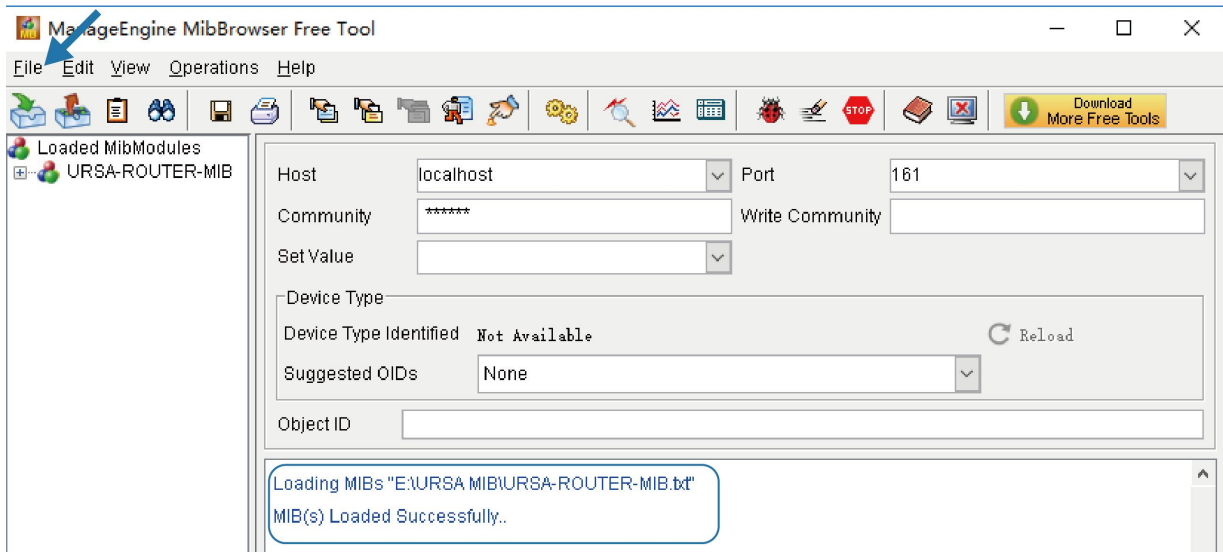

Click the “+” button beside “URSA-ROUTER-MIB”, which is under the “Loaded MibModules” menu, and find “usCellularInfo”. And then you will see the OID of cellular info is “.1.3.6.1.4.1.50234”, which will be filled in the MIB View settings.

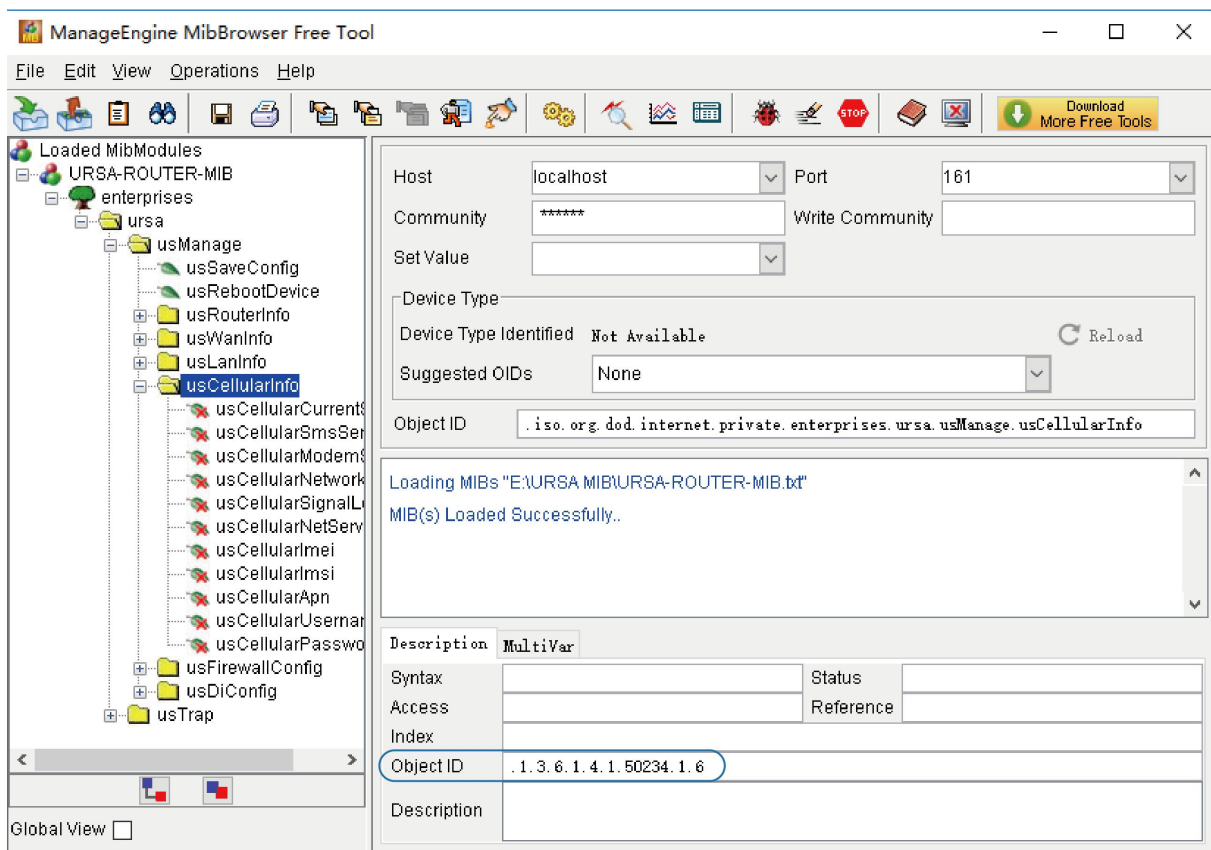

3. Go to “System > SNMP > SNMP” on the WEB GUI. Check “Enable” option, then click “Save” button.

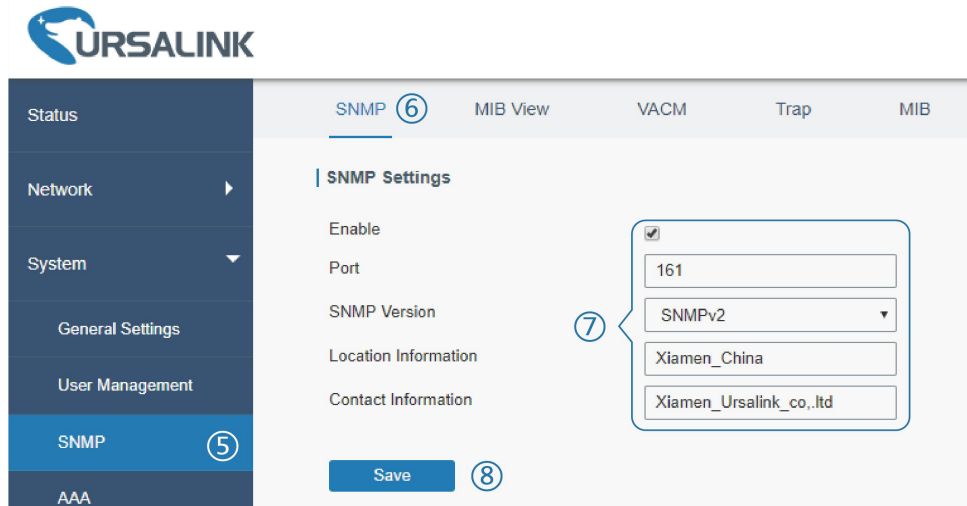

4. Go to “System > SNMP > MIB View”. Click to add a new MIB view and define the view to be accessed from the outside network. Then click “Save” button.
5. Go to “System > SNMP > VACM”. Click to add a new VACM setting to define the access authority

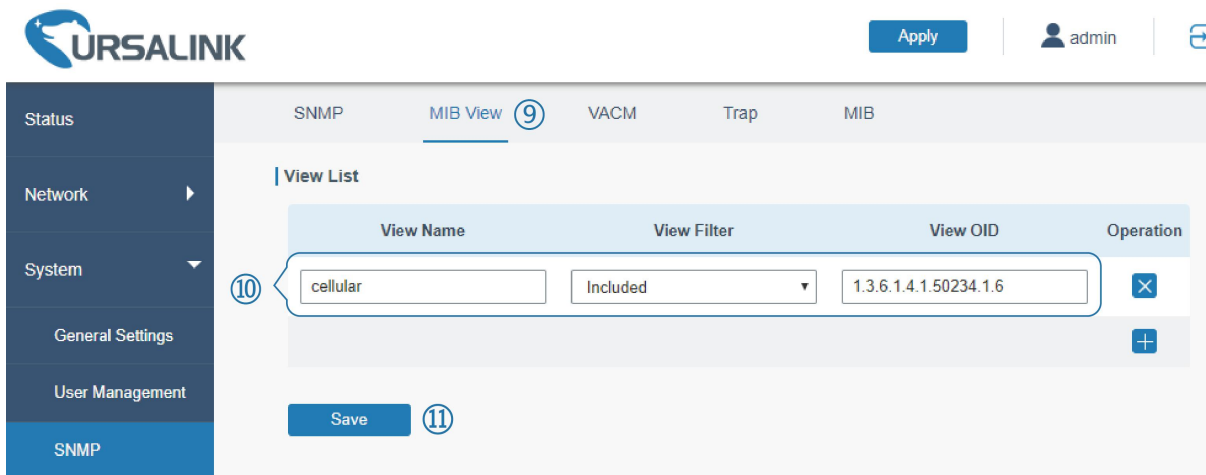

6. for the specified view from the specified outside network. Click “Save” and “Apply” to make the changes take effect.

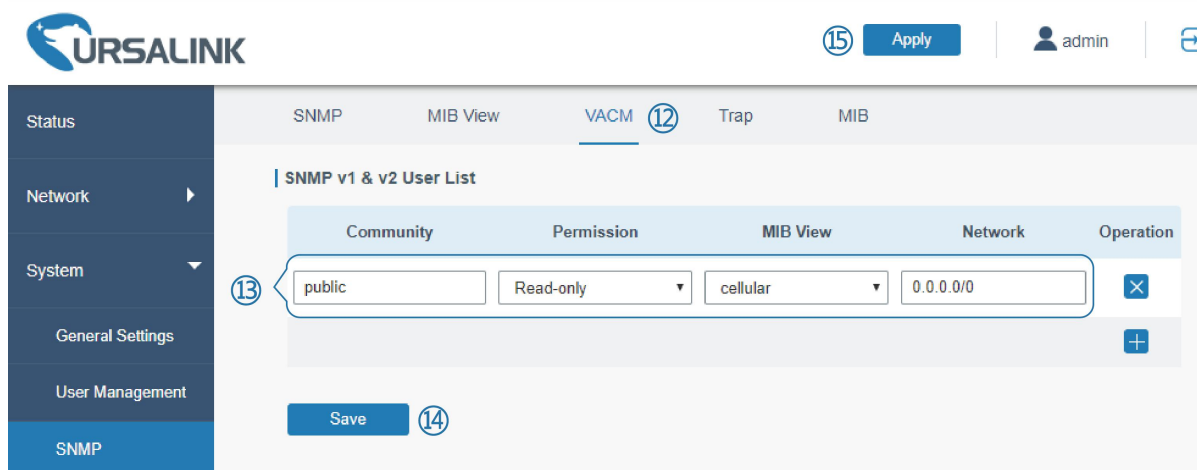

- Go to MibBrowser, enter host IP address, port and community. Right click “usCellular CurrentSim” and then click “GET”. Then you will get the current SIM info on the result box. You can get other cellular info in the same way.

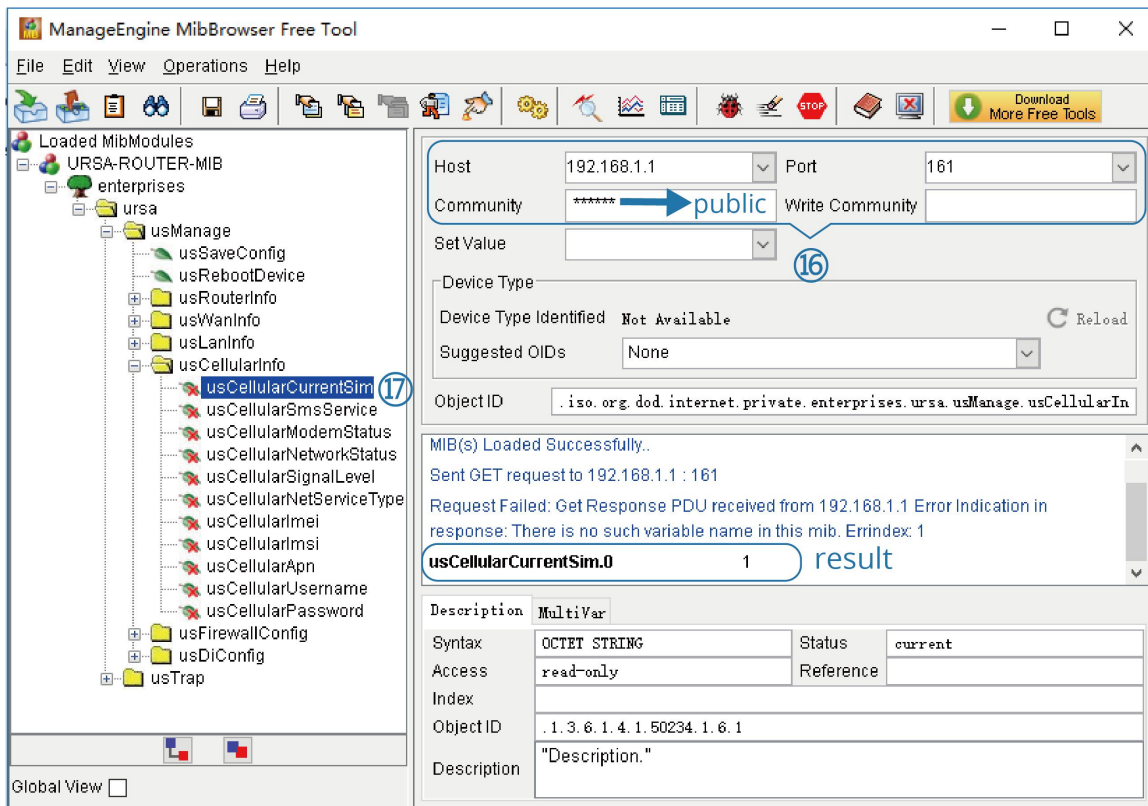

Related Topic

[SNMP](#)

5.11 LAN Management

In LAN Settings, you can configure IP and other parameters of the Ethernet ports which are set as “LAN”.

Example

GE 1 port of UR75 is configured as “LAN”. Parameters are listed below.

Interface	IP Address	Netmask	MTU
GE 1	192.168.1.1	255.255.255.0	1500

Configuration Steps

- Go to “Network > Interface > LAN” to set parameters as below.

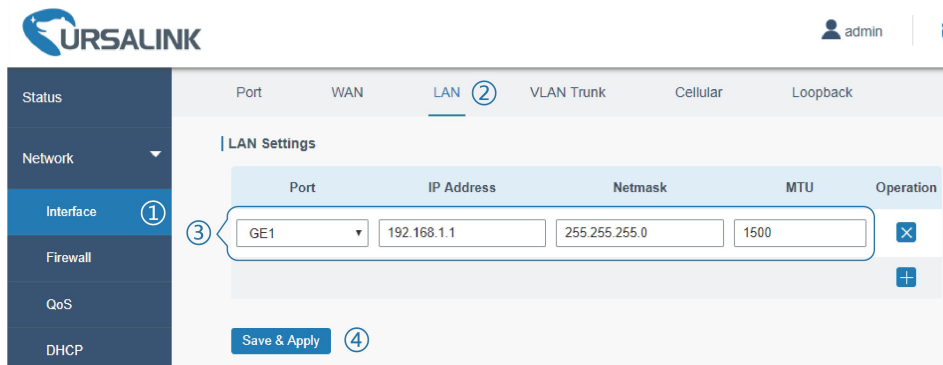

2. Click “Save & Apply” button to make the changes take effect.

Related Topics

[LAN Setting](#)

[LAN Status](#)

5.12 Network Connection

5.12.1 Cellular Connection

The UR75 routers have two cellular interfaces, named SIM1 & SIM2. Only one cellular interface is active at one time. If both cellular interfaces are enabled, SIM1 interface takes precedence as default.

Example

We are about to take an example of inserting a SIM card into SIM1 slot of the UR75 and configuring the router to get Internet access through cellular.

Configuration Steps

1. Go to “Network > Interface > Cellular > Cellular Setting” and configure the cellular info.
2. Enable SIM1.
3. Choose relevant network type. "Auto", "4G First", "4G Only", "3G First", "3G Only", "2G First" and "2G only" are optional.

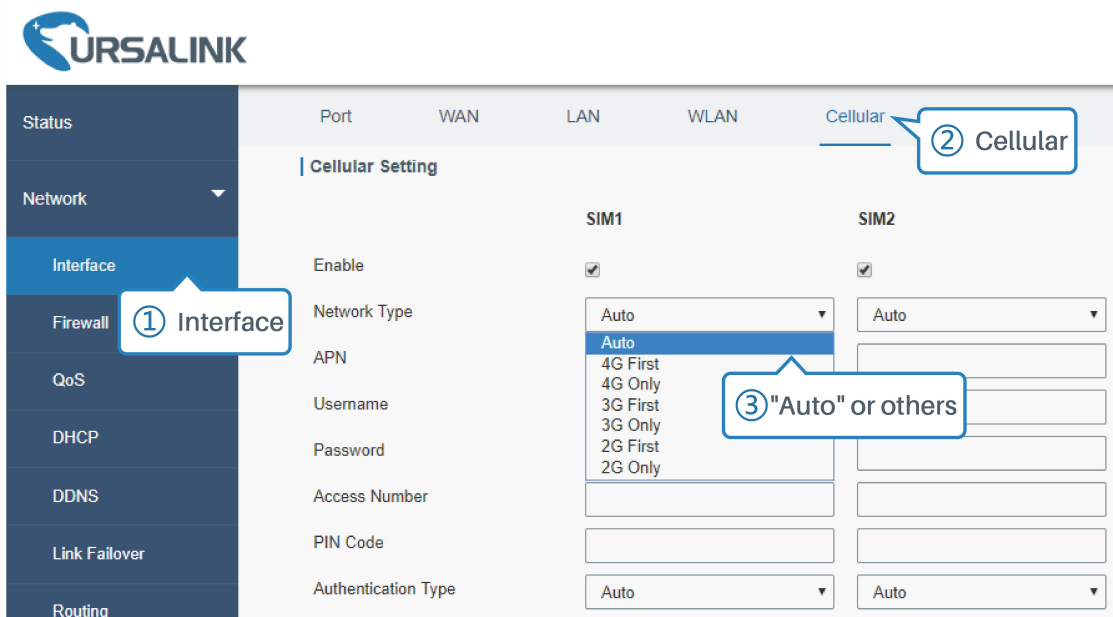

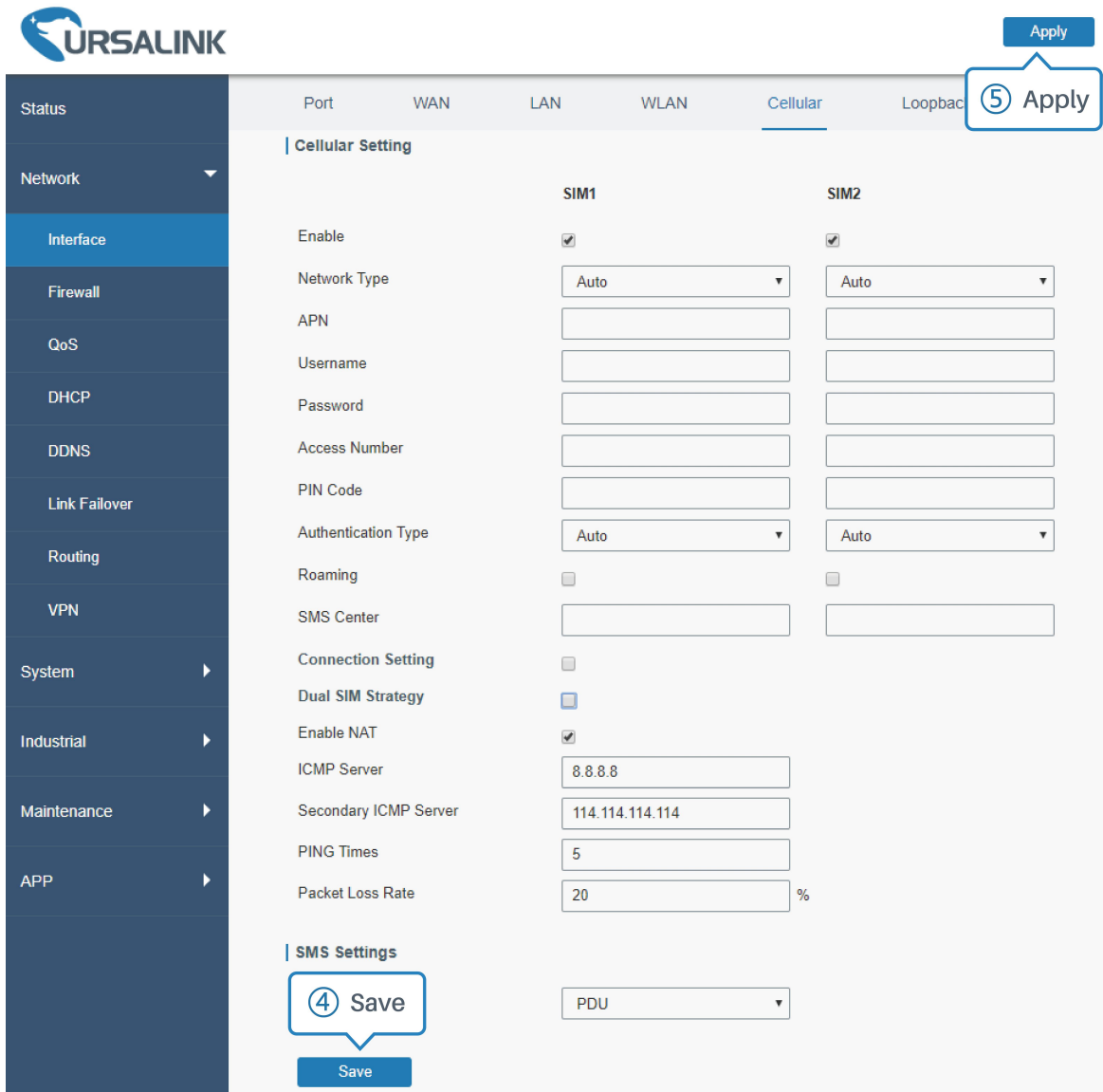

Click “Save” and “Apply” for configuration to take effect.

Note:

If you select “Auto”, the router will obtain ISP information from SIM card to set APN, Username, and Password automatically. This option will only be taken effect when the SIM card is issued from well-known ISP.

If you select “4G First” or “4G Only”, you can click “Save” to finish the configuration directly.

If you select “3G First”, “3G Only”, “2G First” or “2G Only”, you should manually configure APN, Username, Password, and Access Number.

4. Check the cellular connection status by WEB GUI of router.

Click “Status > Cellular” to view the status of the cellular connection. If it shows 'Connected', SIM1 has dialed up successfully.

URSALINK

Status	Overview	Cellular	Network	WLAN	VPN	Routing	Host List	GPS
Network	Modem							
System	Status	Ready						
Industrial	Model	U9300C						
Maintenance	Current SIM	SIM1						
APP	Signal Level	29asu (-56dBm)						
	Register Status	Registered (Home network)						
	IMSI	460070615219248						
	ICCID	898602E6131532019248						
	ISP	CHINA MOBILE						
	Network Type	LTE						
	PLMN ID	46007						
	LAC	fffef						
	Cell ID	f700e28						
	IMEI	862808032459987						
	Network							
	Status	Connected		Connected				
	IP Address	10.39.128.14						
	Netmask	255.255.255.252						
	Gateway	10.39.128.13						
	DNS	211.143.147.120						
	Connection Duration	0 days, 00:15:35						

Manual Refresh ▾ Refresh

5. Check out if network works properly by browser on PC.

Open your preferred browser on PC, type any available web address into address bar and see if it is able to visit Internet via the UR75 router.

Related Topic

[Cellular Setting](#)

[Cellular Status](#)

5.12.2 Ethernet WAN Connection

When both “WAN” and “Cellular” interfaces are enabled and available, cellular interfaces will take precedence by default.

Example

GE 0 of the UR75 is configured as “WAN”, and the port is connected with Ethernet cable to get Internet access.

Configuration Steps

1. Go to “Network > Interface > Cellular” and disable “SIM1” and “SIM2”. Then click “Save” button.

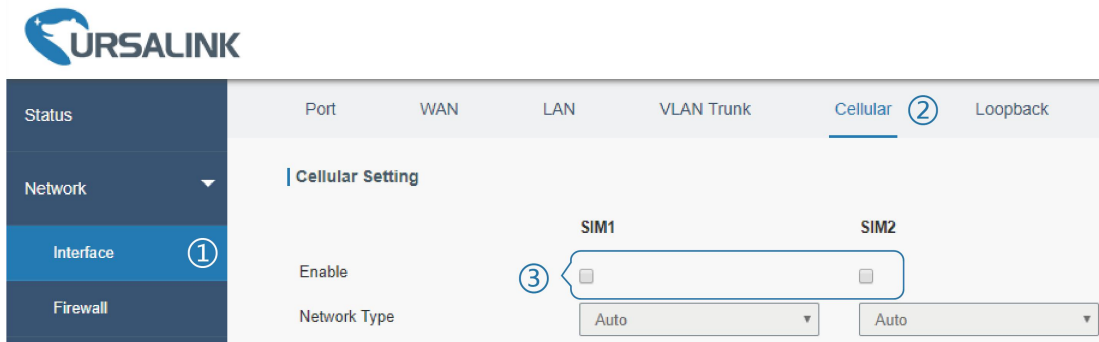

2. Go to “Network > Interface > WAN” to configure WAN parameters. The following examples of static IP type, DHCP Client type, and PPPoE type are listed for your reference.

(1) Static IP

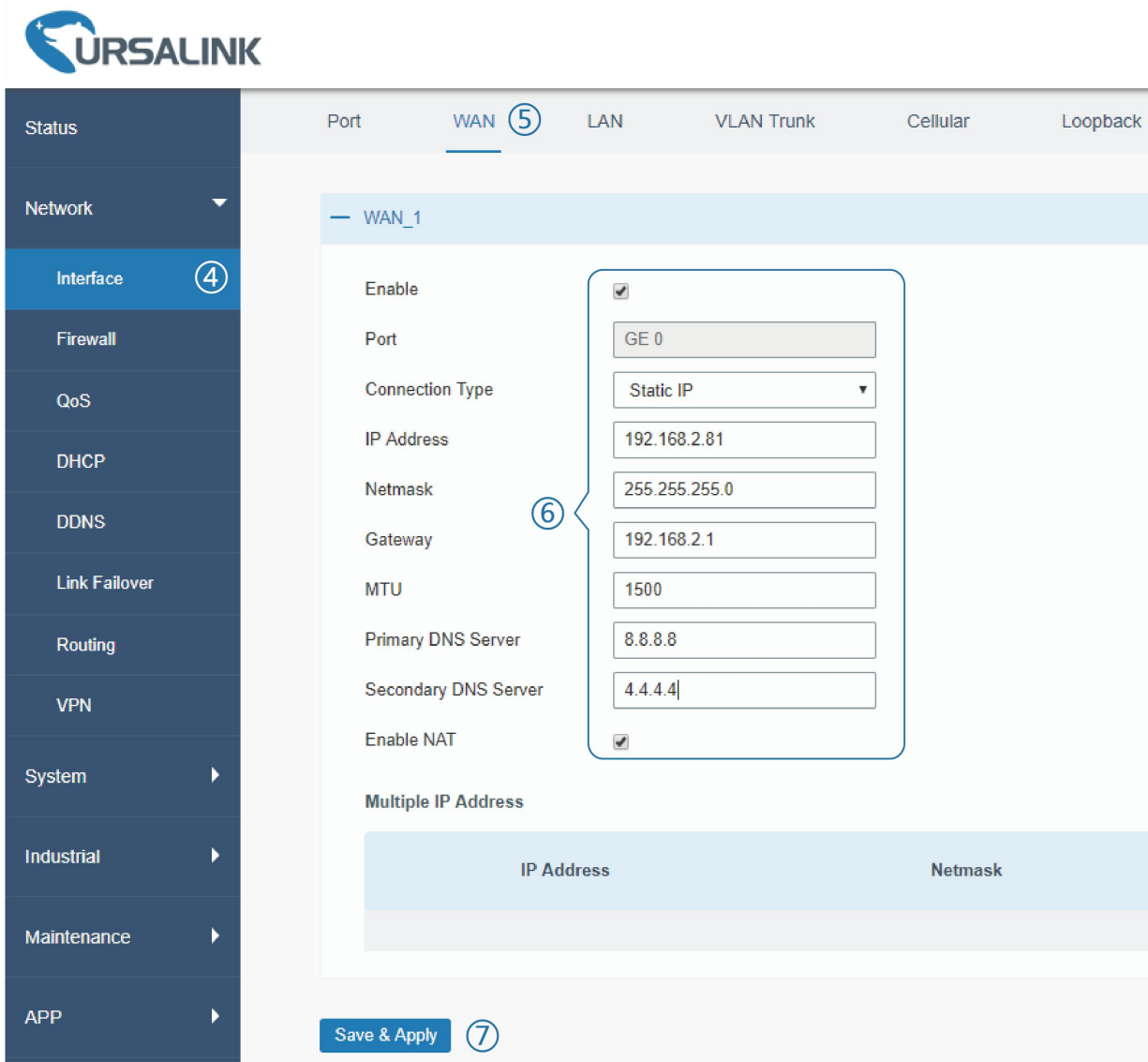

(2) DHCP Client



Status | Port | WAN **5** | LAN | VLAN Trunk | Cellular | Loopback

Network | Interface **4** | Firewall | QoS | DHCP | DDNS | Link Failover | Routing | VPN | System

WAN_1

Enable
 Port
 Connection Type
 MTU
 Use Peer DNS
 Primary DNS Server
 Secondary DNS Server
 Enable NAT

Save & Apply **7**

(3) PPPoE



Status | Port | WAN **5** | LAN | VLAN Trunk | Cellular | Loopback

Network | Interface **4** | Firewall | QoS | DHCP | DDNS | Link Failover | Routing | VPN | System | Industrial | Maintenance

WAN_1

Enable
 Port
 Connection Type
 Username
 Password
 Link Detection Interval(s)
 Max Retries
 MTU
 Use Peer DNS
 Primary DNS Server
 Secondary DNS Server
 Enable NAT

Save & Apply **7**

Note: if you select PPPoE type, please check the “Username” & “Password” with your local ISP. Click “Save & Apply” button to make the changes take effect.

Related Topic

- [WAN Setting](#)
- [WAN Status](#)

5.13 WAN Failover/Backup Application Example

5.13.1 Dual SIM Backup

Example

In this section we will take an example of inserting two SIM cards into the UR75. When one SIM fails, router will try to connect with the other SIM as backup link.

Configuration Steps

1. Go to “Network > Interface > Cellular” to enable SIM1 and SIM2. Leave the network type as “Auto” by default.

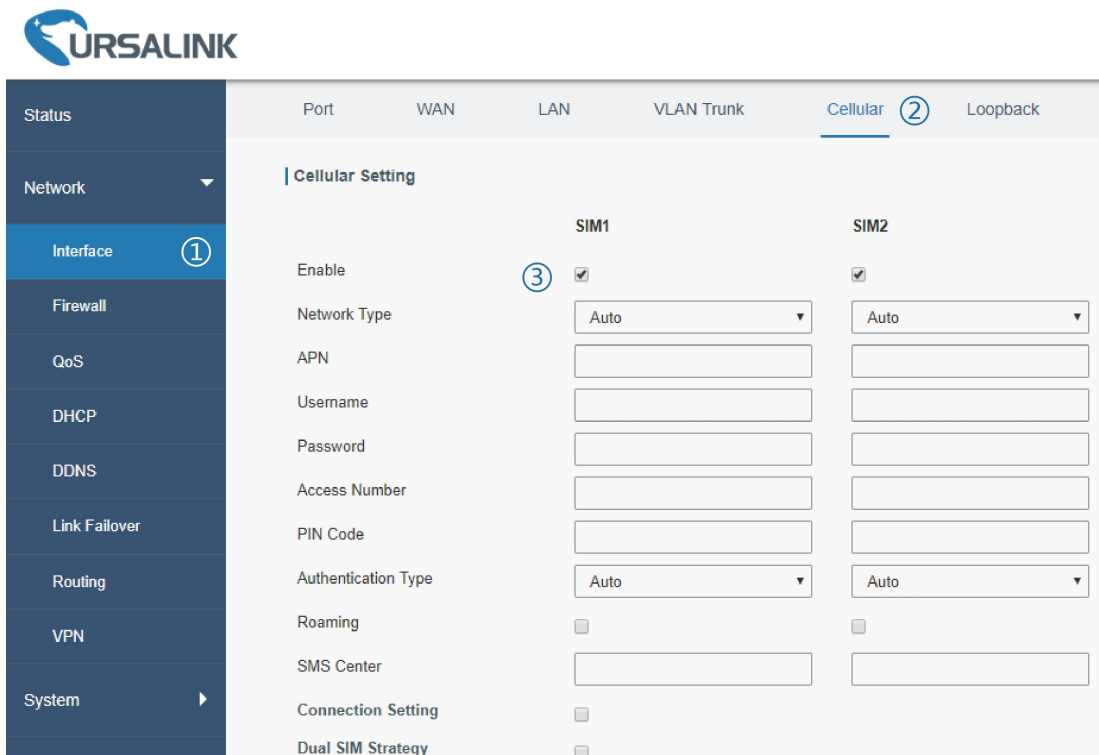

2. Enable “Dual SIM Strategy”, and configure the corresponding options as below. ICMP server can be configured as any reachable IP address.

Then click “Save” and “Apply” button.

3. Go to “Status > Cellular”, and you will see the router is connected to the network via SIM1.

Network	
Status	Connected
IP Address	10.105.39.33

- You can remove SIM1 to make the router fail to connect to network via it. Go to “Status > Cellular” again, and you will see the router is connected to the network through SIM2.



Status	Overview	Cellular	Network	VPN	Routing																
Network	<table border="1"> <thead> <tr> <th colspan="2">Modem</th> </tr> </thead> <tbody> <tr> <td>Status</td> <td>Ready</td> </tr> <tr> <td>Model</td> <td>EC25</td> </tr> <tr> <td>Current SIM</td> <td>SIM2</td> </tr> <tr> <td>Signal Level</td> <td>15asu (-83dBm)</td> </tr> <tr> <td>Register Status</td> <td>Registered (Home network)</td> </tr> <tr> <td>IMSI</td> <td>460019987103071</td> </tr> <tr> <td>ICCID</td> <td>89860117838019196629</td> </tr> </tbody> </table>					Modem		Status	Ready	Model	EC25	Current SIM	SIM2	Signal Level	15asu (-83dBm)	Register Status	Registered (Home network)	IMSI	460019987103071	ICCID	89860117838019196629
Modem																					
Status	Ready																				
Model	EC25																				
Current SIM	SIM2																				
Signal Level	15asu (-83dBm)																				
Register Status	Registered (Home network)																				
IMSI	460019987103071																				
ICCID	89860117838019196629																				
System																					
Industrial																					
Maintenance																					
APP																					

Network	
Status	Connected
IP Address	10.63.223.44

Now SIM2 becomes the main SIM, and SIM1 runs as the backup.

The router won't reconnect via SIM1 until SIM2 fails.

Related Topic

[Cellular Setting](#)

[Cellular Status](#)

5.13.2 WAN Failover

WAN failover involves in Ethernet WAN interface and cellular interface. Either can be used as main WAN interface. If the main interface fails, the router will automatically failover to the backup interface until the main interface functions properly again.

Application Example

An UR75 router is connected with PC via GE 1 (LAN) port, and GE 0 (WAN) of the UR75 is connected to Internet via wired network. Configure WAN failover in the router so that it can failover to cellular to get Internet access in case of the malfunction of wired network and fallback to wired network when it's available again. Please refer to the topological graph below.



Configuration Steps

1. Go to “Network > Interface > WAN” and configure wired WAN connection as below.

The screenshot shows the configuration page for WAN_1. The configuration details are as follows:

- Enable:
- Port: GE 0
- Connection Type: Static IP
- IP Address: 192.168.6.55
- Netmask: 255.255.255.0
- Gateway: 192.168.6.1
- MTU: 1500
- Primary DNS Server: 8.8.8.8
- Secondary DNS Server: 4.4.4.4
- Enable NAT:

At the bottom, there is a table for Multiple IP Address:

IP Address	Netmask	Operation
		+

Buttons: Apply (top right), Save & Apply (bottom left).

When configuration is done, click “Save & Apply” button.
Then confirm if it is able to visit Internet on PC through the UR75.

2. Go to “Network > Interface > Cellular”, enable cellular settings and click “Save” button.



The screenshot shows the 'Cellular' configuration page in the UR75 web interface. The left sidebar contains navigation options: Status, Network (selected), Interface, Firewall, QoS, DHCP, DDNS, Link Failover, Routing, VPN, System, Industrial, Maintenance, and APP. The main content area is titled 'Cellular' and has tabs for Port, WAN, LAN, VLAN Trunk, Cellular (5), and Loopback. Under the 'Cellular' tab, there are sections for 'SIM1' and 'SIM2'. In the 'SIM1' section, the 'Enable' checkbox is checked and circled with a blue '6'. Other settings for SIM1 include Network Type (Auto), APN, Username, Password, Access Number, PIN Code, Authentication Type (Auto), Roaming (unchecked), SMS Center, Connection Setting (unchecked), Dual SIM Strategy (unchecked), Enable NAT (checked), ICMP Server (8.8.8.8), Secondary ICMP Server (114.114.114.114), PING times (5), and Packet Loss Rate (20%). The 'SIM2' section has similar settings, with 'Enable' checked and 'Authentication Type' set to Auto. At the bottom, there is an 'SMS Settings' section with 'SMS Mode' set to PDU. A 'Save' button is circled with a blue '7'.

3. Go to “Network > Link Failover > SLA” and configure SLA probe. The default probe type is ICMP. The destination address is the host address which can be probed by ICMP in public network or private network. Other parameters can be kept as default value.

The screenshot shows the 'SLA' configuration page in the UR75 web interface. The left sidebar is the same as in the previous screenshot. The main content area has tabs for SLA, Track, VRRP, and WAN Failover. Under the 'SLA' tab, there is an 'SLA Entry' section with a table. The table has the following columns: ID, Type, Destination Address, Secondary Destination Address, Data Size, Interval(s), Timeout(ms), PING Times, Packet Loss Rate, Start Time, and Operation. A single entry is visible with ID 1, Type icmp-echo, Destination Address 114.114.114.114, Secondary Destination Address 8.8.8.8, Data Size 56, Interval(s) 30, Timeout(ms) 5000, PING Times 5, Packet Loss Rate 20, Start Time now, and Operation X. There is a 'Save' button at the bottom left of the table.

4. Go to “Network > Link Failover > Track” for Track parameters configuration. You can use the default

Track settings.

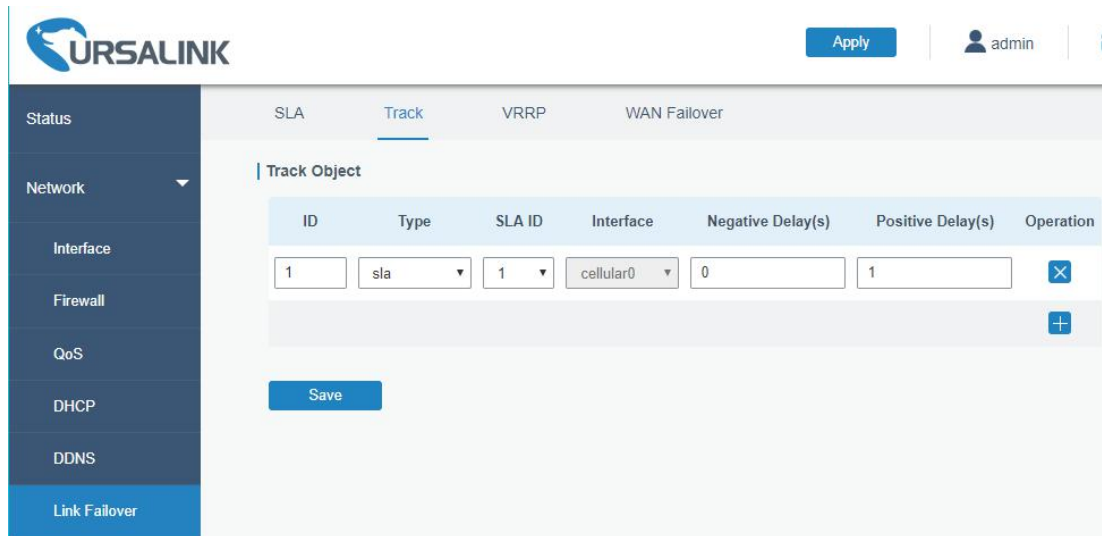

5. Go to “Network > Link Failover > WAN Failover” and select “GE0” as main interface, “cellular0” as backup interface. Other parameters can be kept as default value.

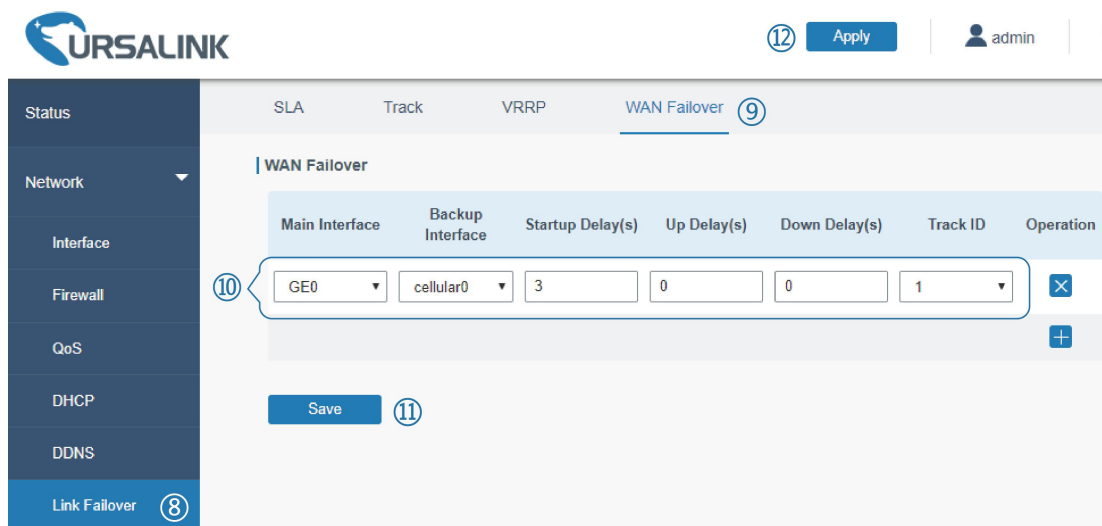

After all configurations are done, click “Apply” button.

6. Login the router via SSH, and use command “show ip route” to check the route table. And you will see the router access to the network via GE0 interface (wired network).

```

URSA> show ip route
Codes: K - kernel route, C - connected, S - static, R - RIP,
       O - OSPF, I - IS-IS, B - BGP, P - PIM, A - Babel,
       > - selected route, * - FIB route
S>* 0.0.0.0/0 [1/0] via 192.168.6.1, GE0
C>* 10.163.64.160/29 is directly connected, cellular0
C>* 127.0.0.0/8 is directly connected, lo
C>* 192.168.6.0/24 is directly connected, GE0
C>* 192.168.66.0/24 is directly connected, GE1
    
```

7. Check how WAN failover functions.
 - (1) Unplug the Ethernet cable from GE 0 port of the router. Check the route table, and you will see the router access to the network via cellular0 interface (SIM).

```
URSA> show ip route
Codes: K - kernel route, C - connected, S - static, R - RIP,
       O - OSPF, I - IS-IS, B - BGP, P - PIM, A - Babel,
       > - selected route, * - FIB route

S>* 0.0.0.0/0 [1/0] via 10.163.64.164, cellular0
C>* 10.163.64.160/29 is directly connected, cellular0
C>* 127.0.0.0/8 is directly connected, lo
C>* 192.168.66.0/24 is directly connected, GE1
```

- (2) Plug the Ethernet cable to GE 0 port again. Check the route table, and you will see the router access to the network via GE0 interface (wired network) again.

```
URSA> show ip route
Codes: K - kernel route, C - connected, S - static, R - RIP,
       O - OSPF, I - IS-IS, B - BGP, P - PIM, A - Babel,
       > - selected route, * - FIB route

S>* 0.0.0.0/0 [1/0] via 192.168.6.1, GE0
C>* 10.163.64.160/29 is directly connected, cellular0
C>* 127.0.0.0/8 is directly connected, lo
C>* 192.168.6.0/24 is directly connected, GE0
C>* 192.168.66.0/24 is directly connected, GE1
```

Related Topics

[WAN Setting](#)

[Cellular Setting](#)

[Track Setting](#)

[SLA Setting](#)

[WAN Failover Setting](#)

5.14 Wi-Fi Application Example (Only Applicable to Wi-Fi Version)

5.14.1 AP Mode

Application Example

Configure UR75 as AP to allow connection from users or devices.

Configuration Steps

1. Go to "Network > Interface > WLAN" to configure wireless parameters as below.

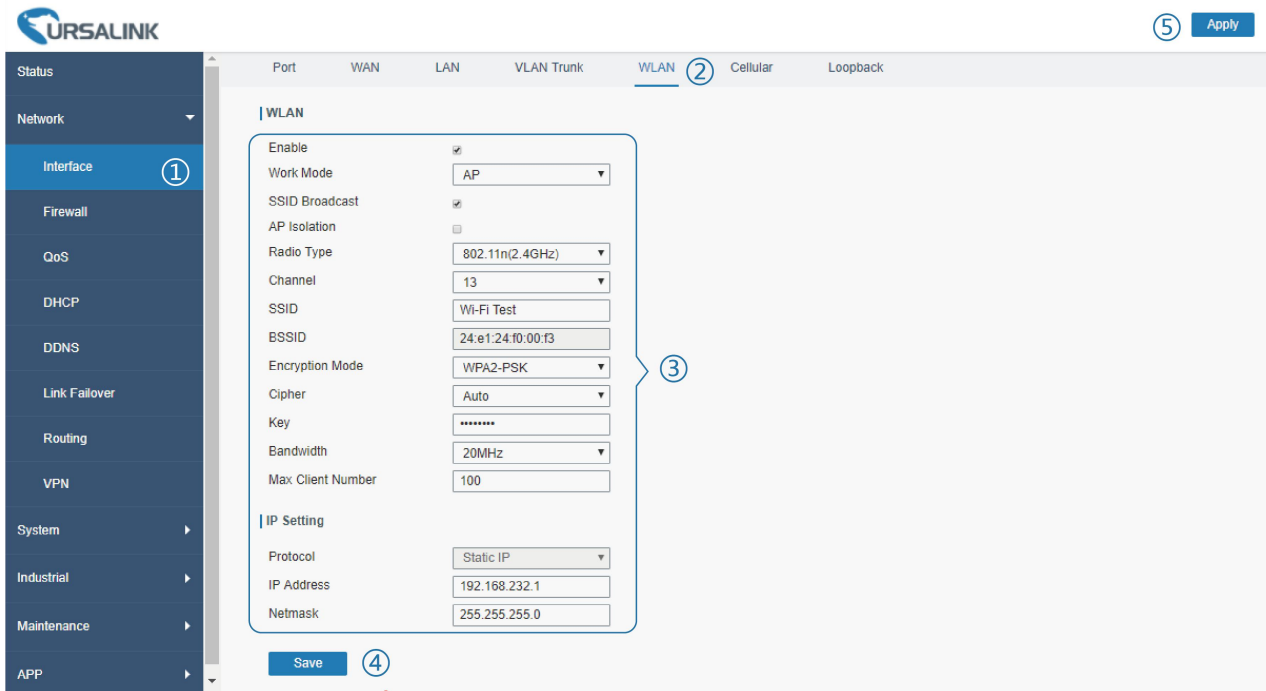

The IP address must be in different network segment from the LAN IP address.

Click “Save” and “Apply” button after all configurations are done.

2. Use a smart phone to connect by SSID “Wi-Fi Test”. Go to “Status > WLAN”, and you can check the AP settings and information of the connected client/user.

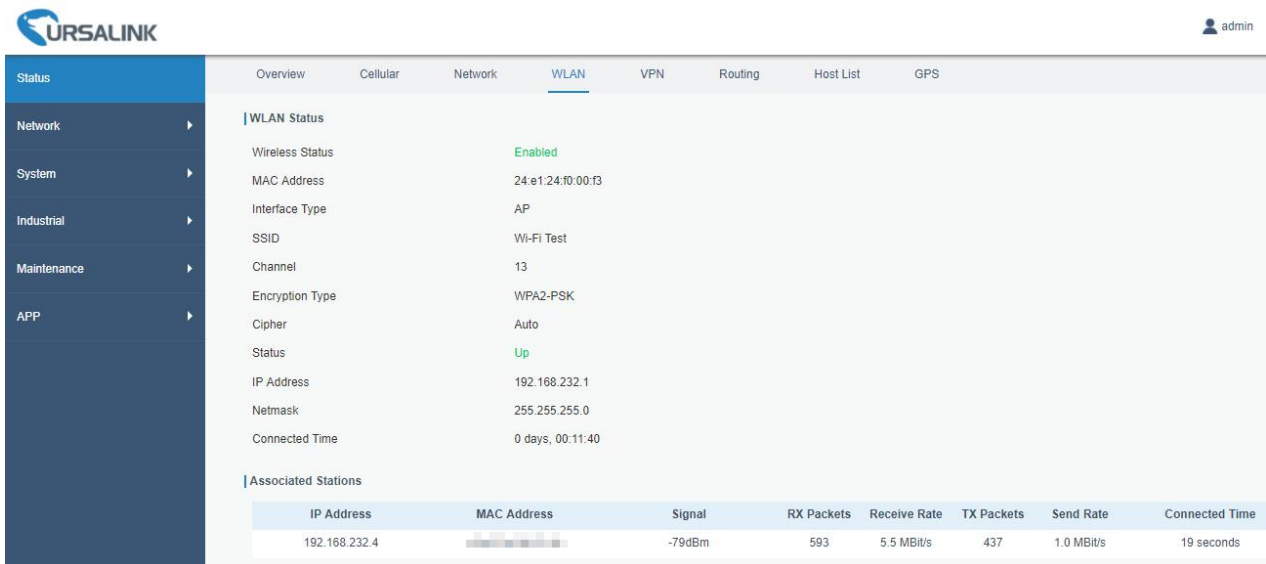

5.14.2 Client Mode

Application Example

Configure UR75 as Wi-Fi client to connect to an access point to have Internet access.

Configuration Steps

1. Go to “Network > Interface > WLAN” to configure wireless as below.

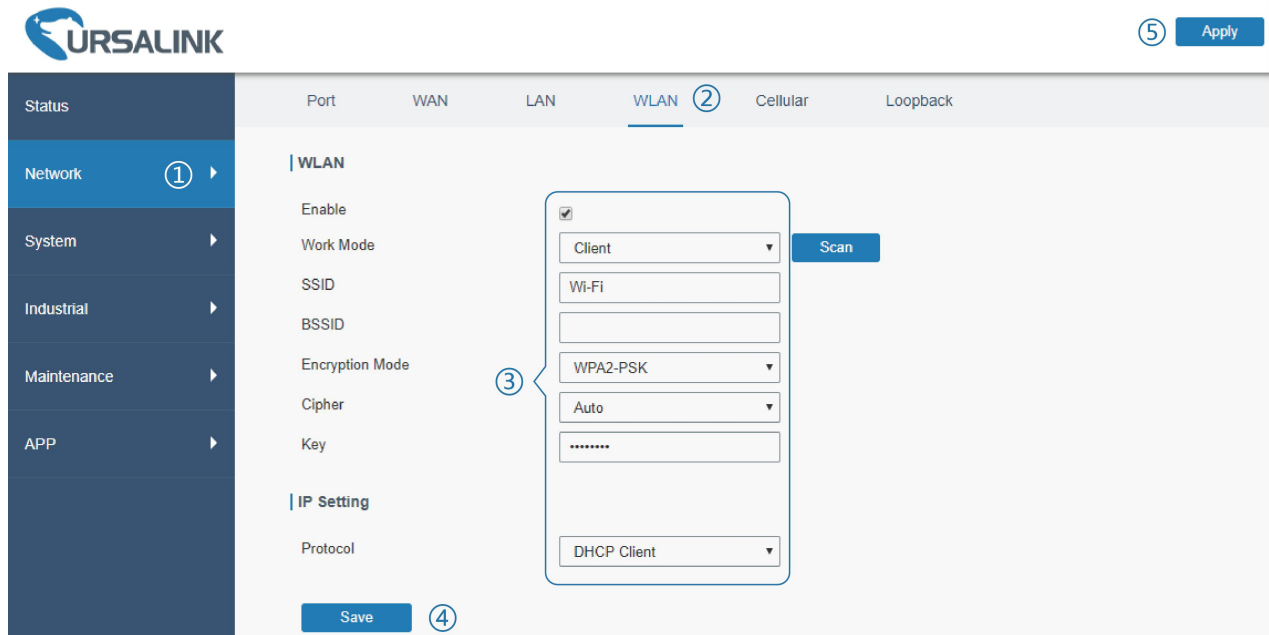

Click “Save” and “Apply” button after all configurations are done.

2. Go to “Status > WLAN”, and you can check the wireless settings, connection status and the information of the access point.

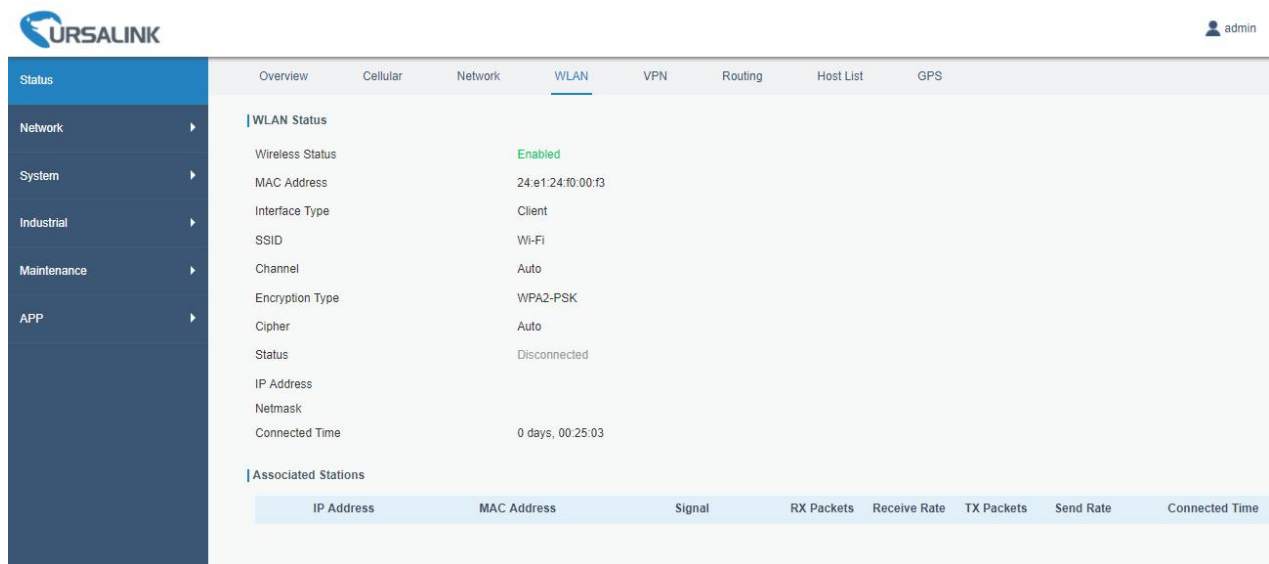

Related Topic

[WLAN Setting](#)

[WLAN Status](#)

5.15 VRRP Application Example

Application Example

A Web server requires Internet access through the UR75 router. To avoid data loss caused by router breakdown, two UR75 routers can be deployed as VRRP backup group, so as to improve network reliability.

VRRP group:

GE 0 ports of the UR75 Router A and Router B are connected to the Internet via wired network. And GE 1 ports of them are connected to a switch.

Virtual IP is 192.168.1.254/24.

UR75 Router	Virtual Router ID (Same for A and B)	Port connected with switch	LAN IP Address	Priority	Preemption Mode
A	1	GE 1	192.168.1.1	110	Enable
B	1	GE 1	192.168.1.2	100	Disable

Refer to the topological below.

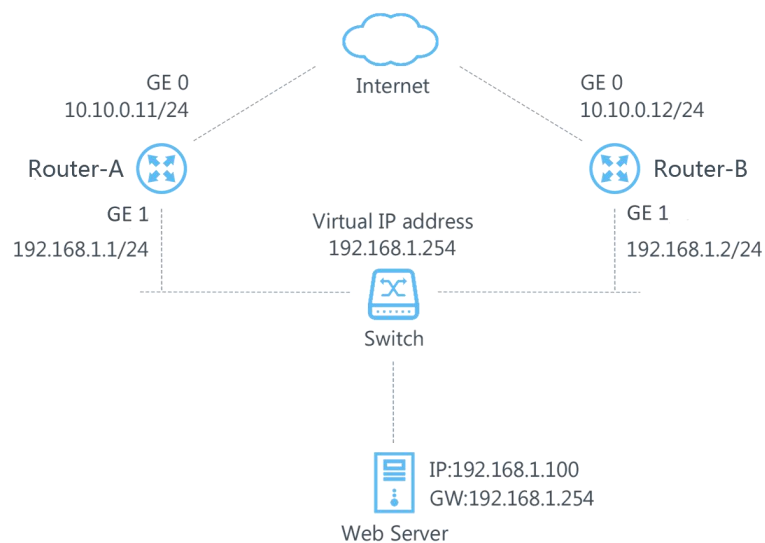

Configuration Steps

Router A Configuration

1. Go to "Network > Interface > WAN" and configure wired WAN connection as below.

URSA LINK

Apply | adm

Status | Port | **WAN** (2) | LAN | VLAN Trunk | Cellular | Loopback

Network

Interface (1)

Firewall

QoS

DHCP

DDNS

Link Failover

Routing

VPN

System

Industrial

Maintenance

APP

WAN_1

Enable

Port GE 0

Connection Type Static IP

IP Address 10.10.0.11

Netmask 255.255.255.0

Gateway 10.10.0.1

MTU 1500

Primary DNS Server 8.8.8.8

Secondary DNS Server 4.4.4.4

Enable NAT

Multiple IP Address

IP Address	Netmask	Operation
		+

Save & Apply (4)

- Go to “Network > Link Failover > SLA” and configure SLA probe. The default probe type is ICMP. The destination address is the host address which can be probed by ICMP in public network or private network. Other parameters can be kept as default value.

URSA LINK

Apply | admin

Status | **SLA** | Track | VRRP | WAN Failover

Network

Interface

Firewall

QoS

DHCP

DDNS

Link Failover

SLA Entry

ID	Type	Destination Address	Secondary Destination Address	Data Size	Interval(s)	Timeout(ms)	PING Times	Packet Loss Rate	Start Time	Operation
1	icmp-echo	114.114.114.114	8.8.8.8	56	30	5000	5	20	now	✕
										+

Save

- Go to “Network > Link Failover > Track” and configure link track parameters. You can use the default Track settings.

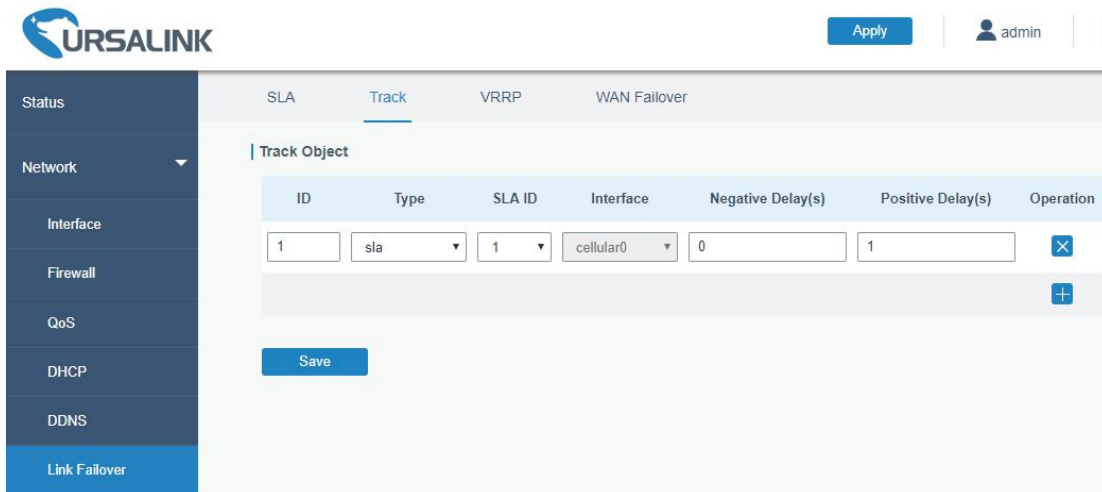

- Go to “Network > Link Failover > VRRP” and configure VRRP parameters as below.

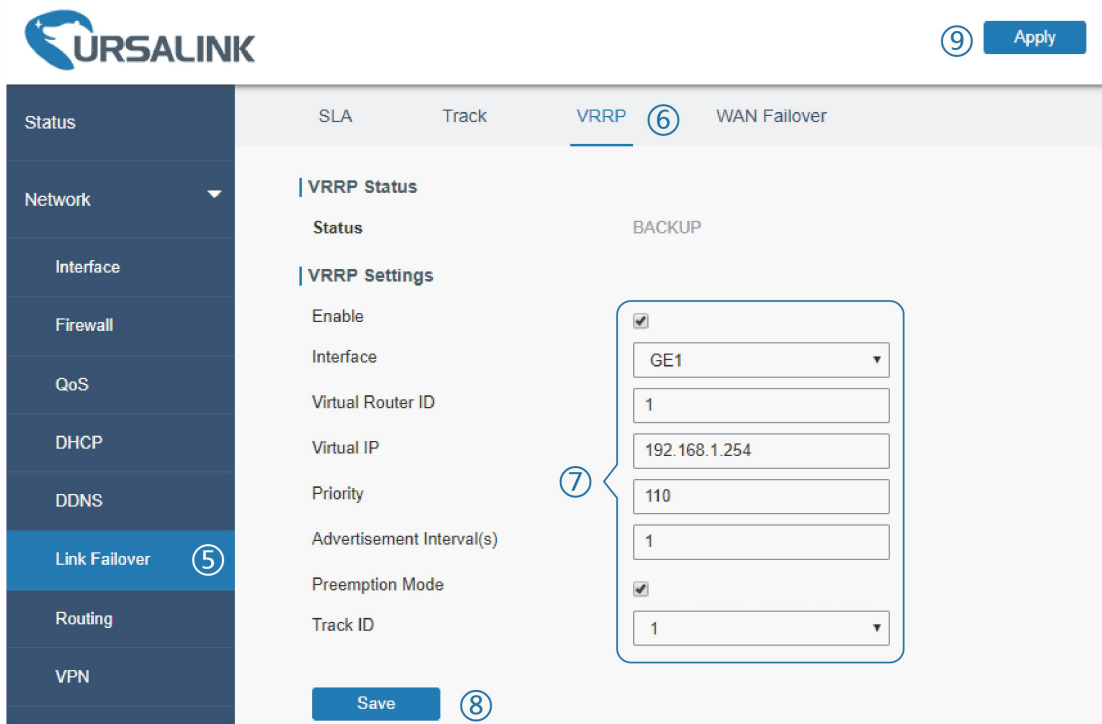

Router B Configuration

- Go to “Network > Interface > WAN” and configure wired WAN connection as below.

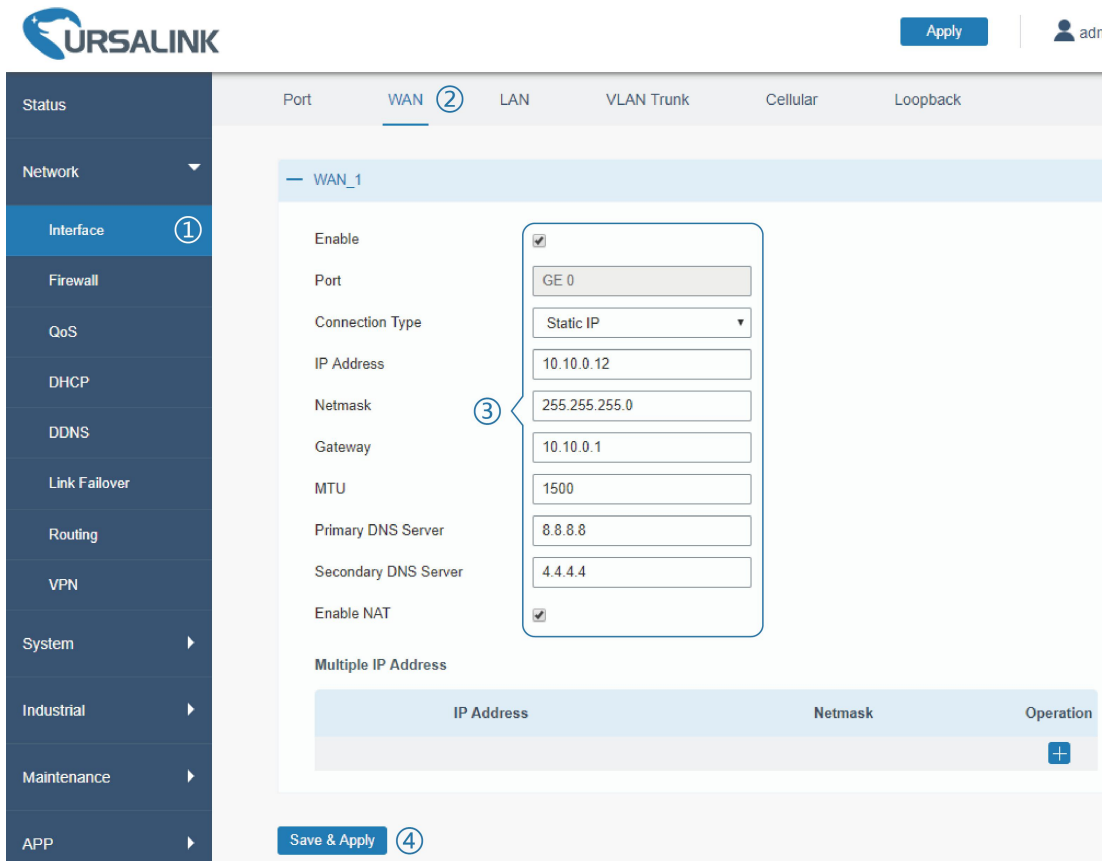

- Go to “Network > Link Failover > SLA” and configure SLA probe. The default probe type is ICMP. The destination address is the host address which can be probed by ICMP in public network or private network. Other parameters can be kept as default value.

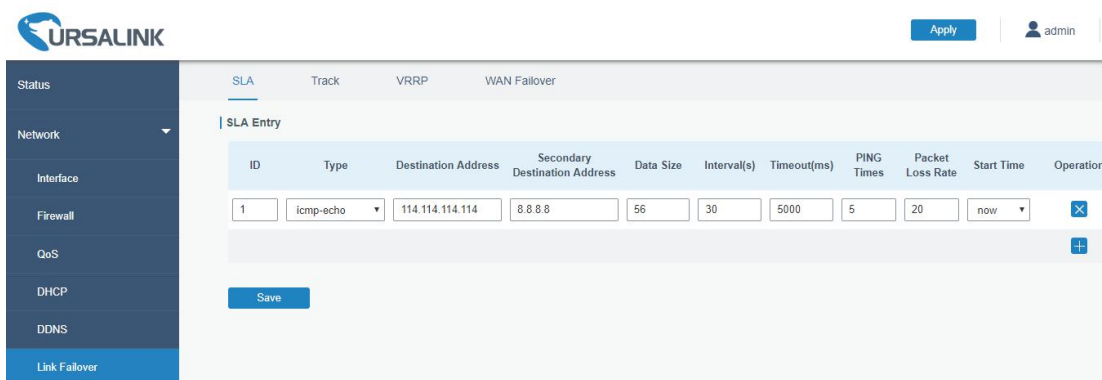

- Go to “Network > Link Failover > Track” and configure link track parameters. You can use the default Track settings.

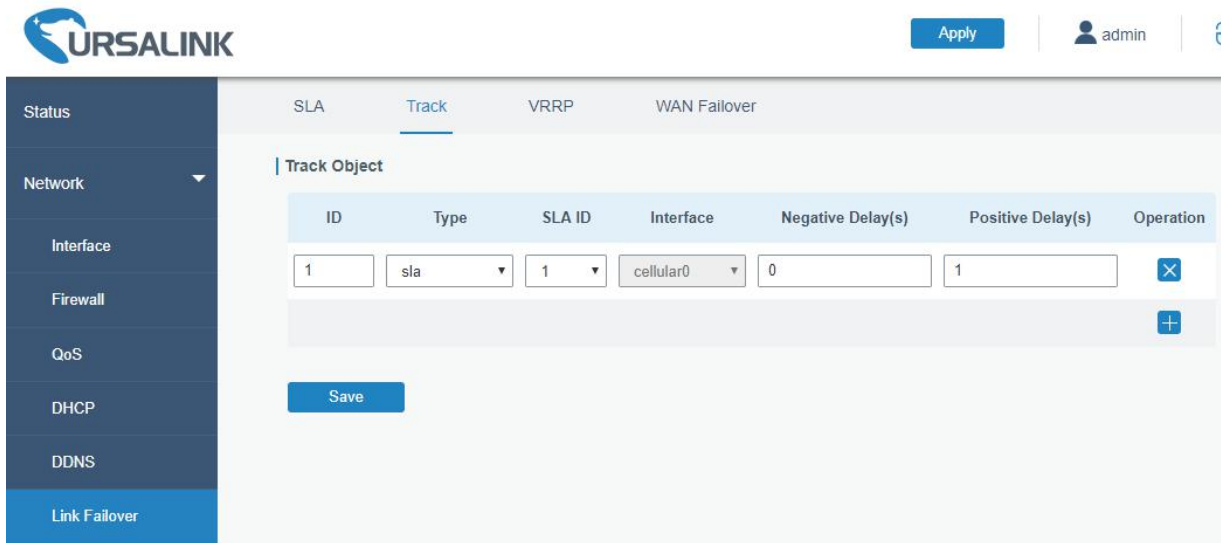

4. Go to “Network > Link Failover > VRRP” and configure VRRP parameters as below.

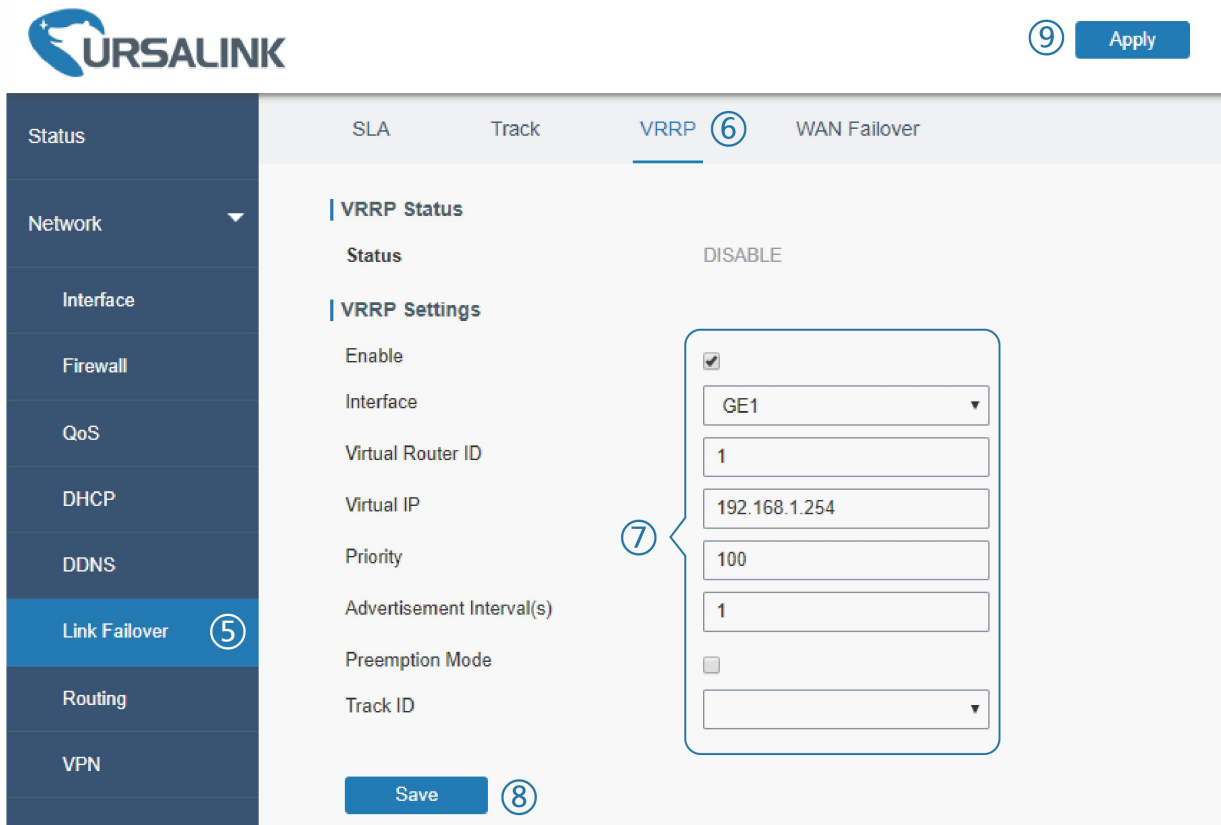

Once you complete all configurations, click “Apply” button on the top-right corner to make changes take effect.

Result: normally, A is the master router, used as the default gateway. When the power of Router A is down or Router A suffers from failure, Router B will become the master router, used as the default gateway. With Preemption Mode enabled, Router A will be master and Router B will demote back to be the backup once Router A can access the Internet again.

Related Topics

[VRRP Setting](#)

[Track Setting](#)

[SLA Setting](#)

5.16 Static Routing Application Example

Static routing can build up the communication between 2 different private networks.

Application Example

The UR75 Router A and the UR75 Router B are connected with GE 0 (WAN) port as shown in the following topological graph.

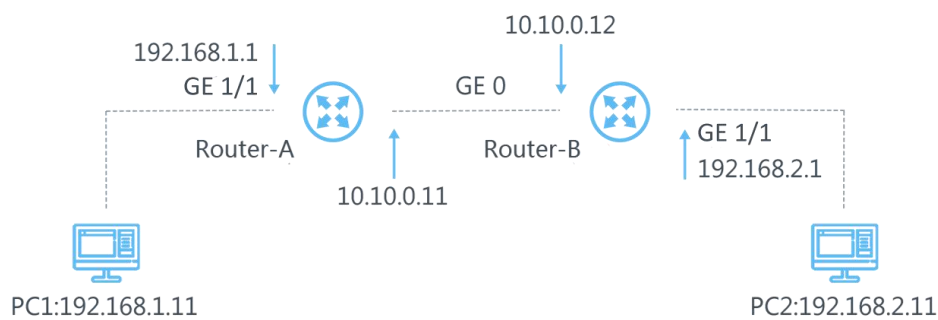

Add static routing in A and B to make PC1 and PC2 communicate with each other.

Configuration Steps

Configure the Router A

1. Go to “Network > Routing > Static Routing”.
2. Click “+” to set a new static routing parameters as below. Track ID can be null.

Destination	Netmask	Interface	Gateway	Distance	Track ID	Operation
192.168.2.0	255.255.255.0	GE0	10.10.0.12	1		✕
0.0.0.0	255.255.255.0	GE0	10.10.0.1	1		✕

Click “Save” and “Apply” button.

Configure the Router B

Repeat the above configuration steps on the Router B and configure the routing parameters as below.

Click “Save” and “Apply” button.

Related Topic

[Static Routing](#)

5.17 Dynamic Routing Application Example

Example

The UR75 Router A and the UR75 Router B are connected with GE 0 (WAN) port. Refer to the below topological graph.



Add dynamic routing in Router A and Router B to establish communication between PC1 and PC2.

Configuration Steps

Router A Configuration

1. Go to “Network > Interface > WAN” and configure WAN parameters.

WAN_1

Enable

Port

Connection Type

IP Address

Netmask

Gateway

MTU

Primary DNS Server

Secondary DNS Server

Enable NAT

- Go to “Network > Interface > LAN” and configure LAN parameters.

LAN Settings

Port	IP Address	Netmask	MTU	Operation
GE1	192.168.1.3	255.255.255.0	1500	<input type="button" value="X"/>
				<input type="button" value="+"/>

- Go to “Network > Routing > RIP” and configure dynamic routing parameters.

RIP Settings

Enable

Update Timer s

Timeout Timer s

Garbage Collection Timer s

Version

Show Advanced Options

IP Address	Netmask	Operation
192.168.2.0	255.255.255.0	<input type="button" value="X"/>
192.168.1.0	255.255.255.0	<input type="button" value="X"/>
		<input type="button" value="+"/>

Click “Save” and “Apply” button.

Router B Configuration

- Go to “Network > Interface > WAN” and configure WAN parameters.

- Go to “Network > Interface > LAN” and configure LAN parameters.

LAN Settings

Port	IP Address	Netmask	MTU	Operation
GE1 ▼	192.168.3.1	255.255.255.0	1500	✕
				+

WAN_1

Enable

Port

Connection Type

IP Address

Netmask

Gateway

MTU

Primary DNS Server

Secondary DNS Server

Enable NAT

- Go to “Network > Routing > RIP” and configure dynamic routing parameters.

RIP Settings

Enable

Update Timer s

Timeout Timer s

Garbage Collection Timer s

Version

Show Advanced Options

Network		
IP Address	Netmask	Operation
<input type="text" value="192.168.3.0"/>	<input type="text" value="255.255.255.0"/>	<input type="button" value="X"/>
<input type="text" value="192.168.2.0"/>	<input type="text" value="255.255.255.0"/>	<input type="button" value="X"/>
		<input type="button" value="+"/>

Click “Save” and “Apply” button.

Once you complete all configurations, PC1 and PC2 can communicate with each other.

Related Topic

[RIP Setting](#)

5.18 NAT Application Example

Example

An UR75 router can access Internet via cellular. GE 1 port is connected with a Web server whose IP address is 192.168.1.2 and port is 8000. Configure the router to make public network access the server.

Configuration Steps

Go to “Firewall > Port Mapping” and configure port mapping parameters.

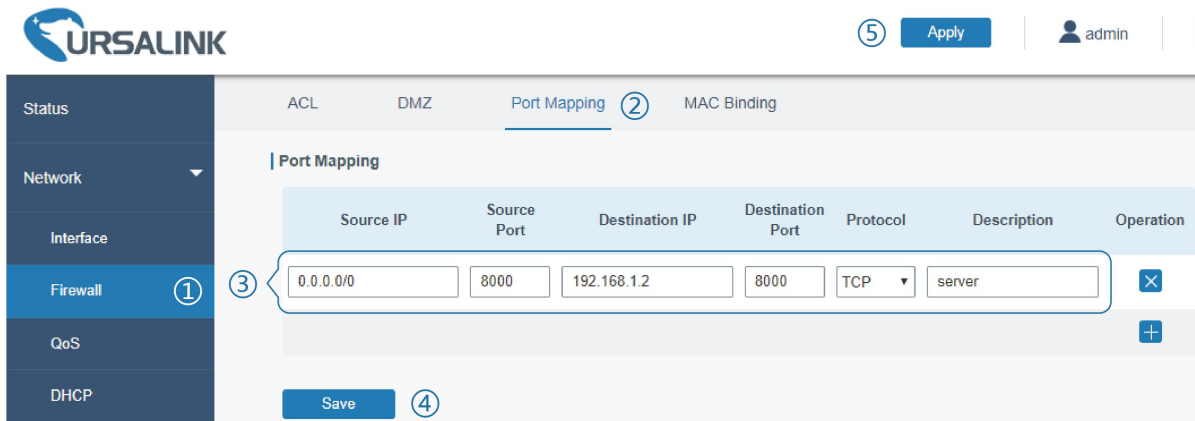

Click “Save” and “Apply” button.

Related Topic

[Port Mapping](#)

5.19 Access Control Application Example

Application Example

GE 1 port of the UR75 is set as LAN with IP 192.168.1.0/24. Then configure the router to deny accessing to Google IP 198.98.108.64 from local device with IP 192.168.1.12.

Configuration Steps

- Go to “Network > Firewall > ACL” to configure access control list. Click “+” button to set parameters as below. Then click “Save” button.

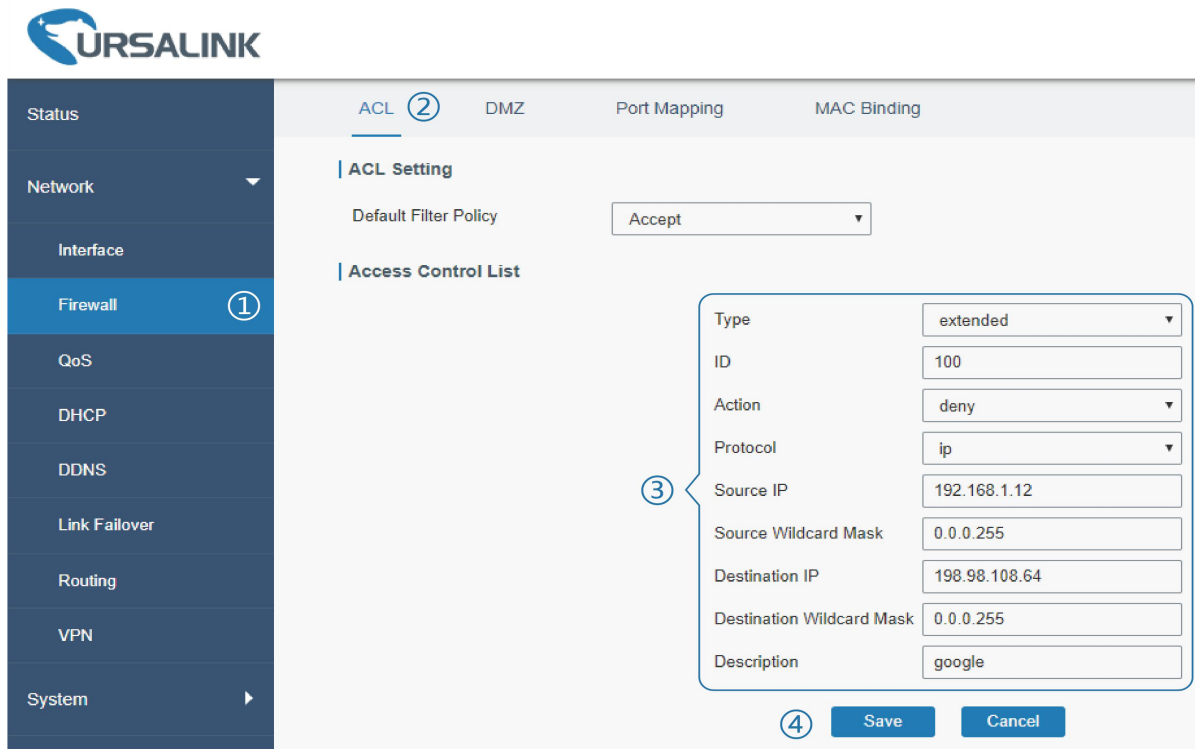

- Configure interface list. Then click “Save” and “Apply” button.

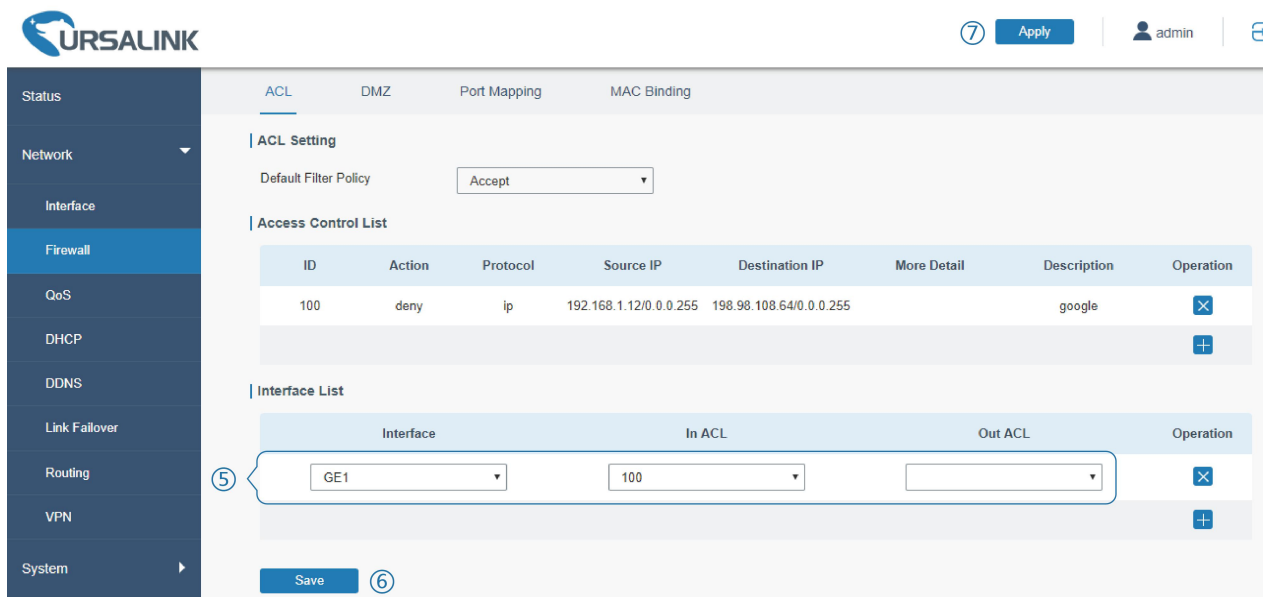

Related Topic

[ACL](#)

5.20 QoS Application Example

Example

Configure the UR75 router to distribute local preference to different FTP download channels. The total download bandwidth is 75000 kbps.

Note: the “Total Download Bandwidth” should be less than the real maximum bandwidth of WAN or cellular interface.

FTP Server IP & Port	Percent	Max Bandwidth(kbps)	Min Bandwidth(kbps)
110.21.24.98:21	40%	30000	25000
110.32.91.44:21	60%	45000	40000

Configuration Steps

1. Go to “Network > QoS > QoS(Download)” to enable QoS and set the total download bandwidth.

2. Please find “Service Classes” option, and click “+” to set up service classes.

Note: the percents must add up to 100%.

Name	Percent(%)	Max BW(kbps)	Min BW(kbps)	Operation
1	40	30000	25000	
2	60	45000	40000	

3. Please find “Classification Rules” option, and click “+” to set up rules.

Name	Source IP	Source Port	Destination IP	Destination Port	Protocol	Service Class	Operation
ftp1	110.21.24.98	21			ANY	1	
ftp2	110.32.91.44	21			ANY	2	

Click “Save” and “Apply” button.

Note: IP/Port: null refers to any IP address/port.

Related Topic

[QoS Setting](#)

5.21 DTU Application Example

Example

PLC is connected with the UR75 via RS232. Then enable DTU function of the UR75 to make a remote TCP server communicate with PLC. Refer to the following topological graph.

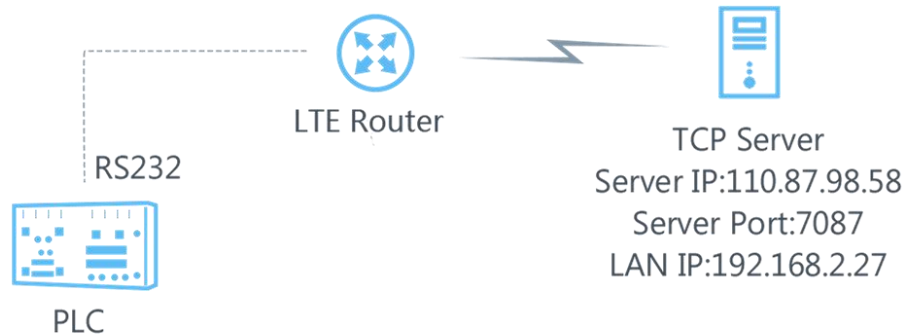

Serial Parameters of the PLC	
Baud Rate	9600
Data Bit	8
Stop Bit	1
Parity	None

Configuration Steps

1. Go to “Industrial > Serial Port > Serial 1” and configure serial port parameters. The serial port parameter shall be kept in consistency with those of PLC, as shown in figure below.

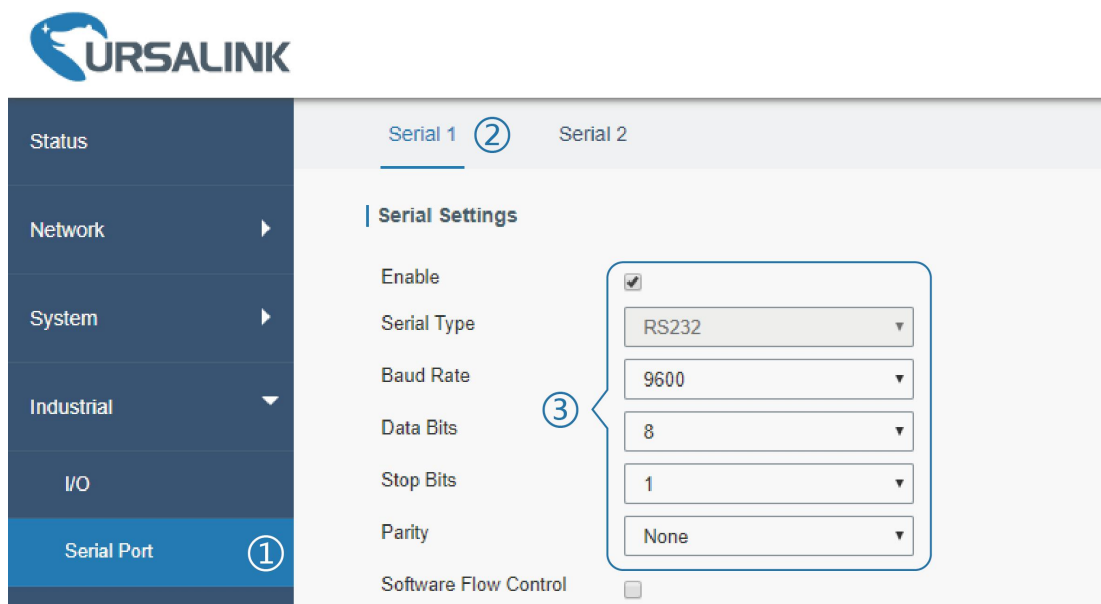

2. Configure Serial Mode as “DTU Mode”. The UR75 is connected as client in “Transparent” protocol.

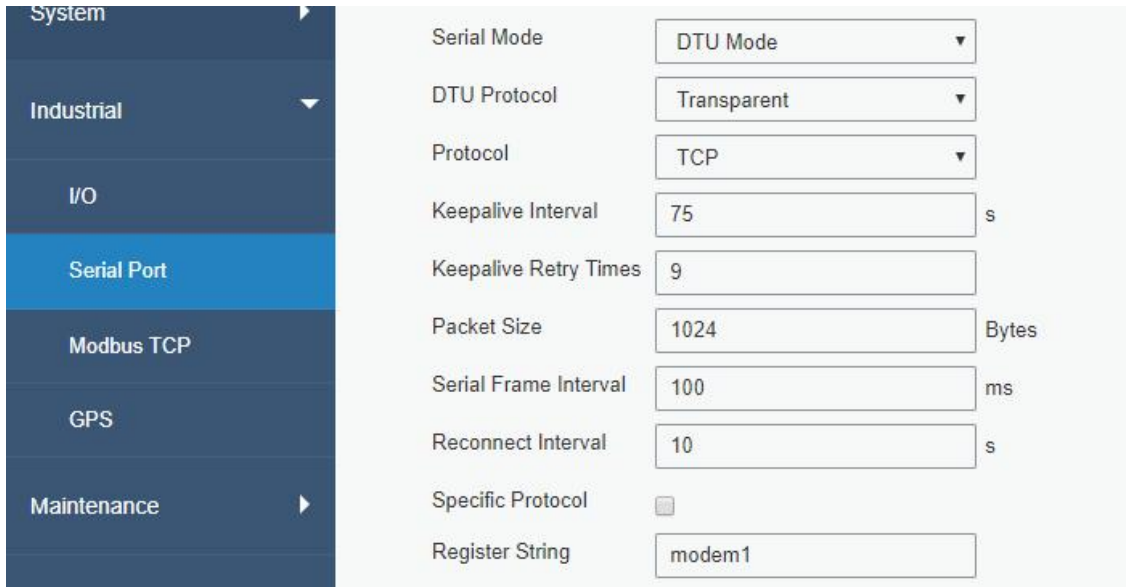

3. Configure TCP server IP and port.

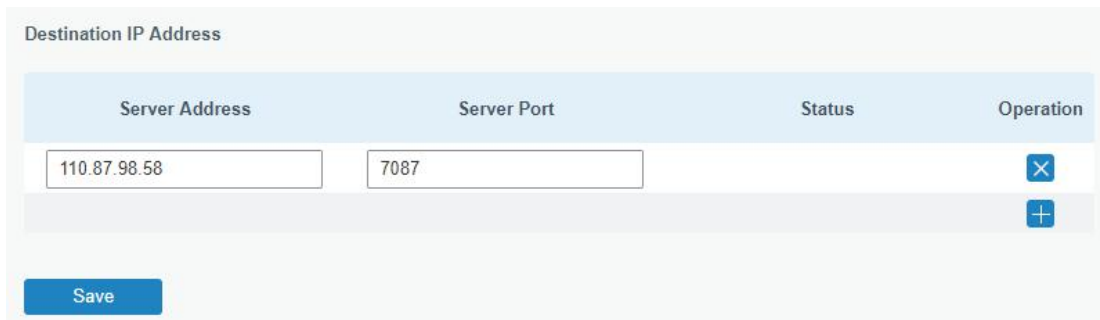

4. Once you complete all configurations, click “Save” and “Apply” button.

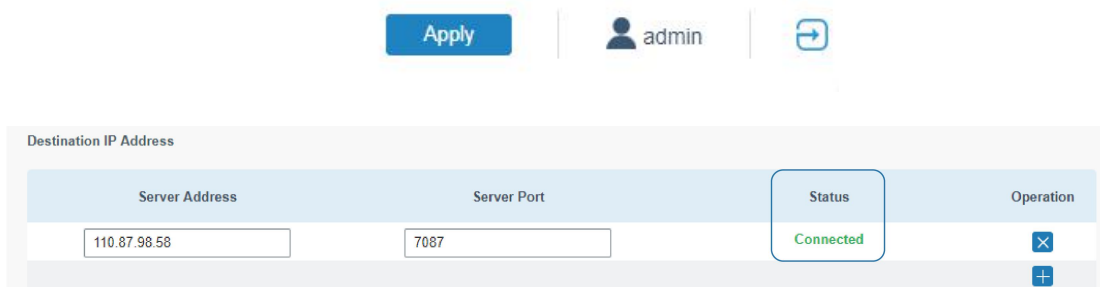

5. Start TCP server on PC.

Take “Netassist” test software as example. Make sure port mapping is already done.



6. Connect the UR75 to PC via RS232 for PLC simulation. Then start “sscom” software on the PC to test communication through serial port.



7. After connection is established between the UR75 and the TCP server, you can send data between sscom and Netassit.

PC side

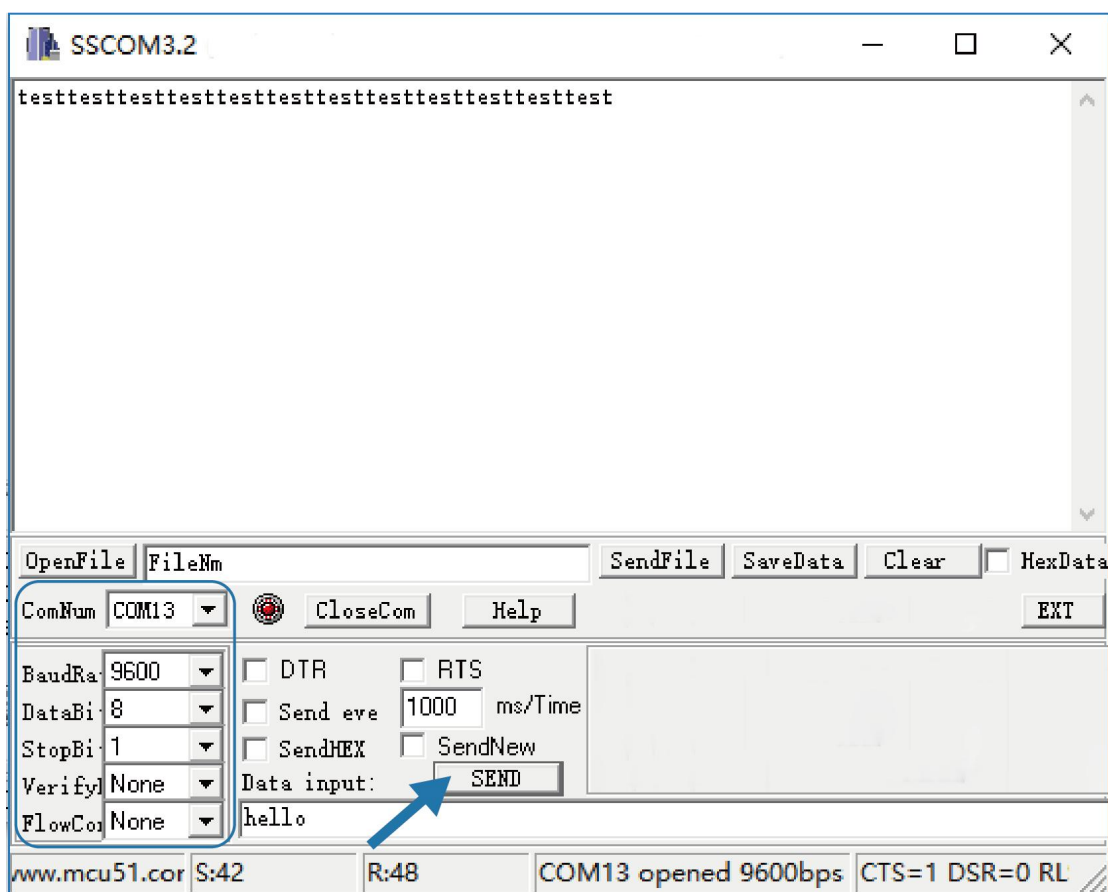

TCP server side

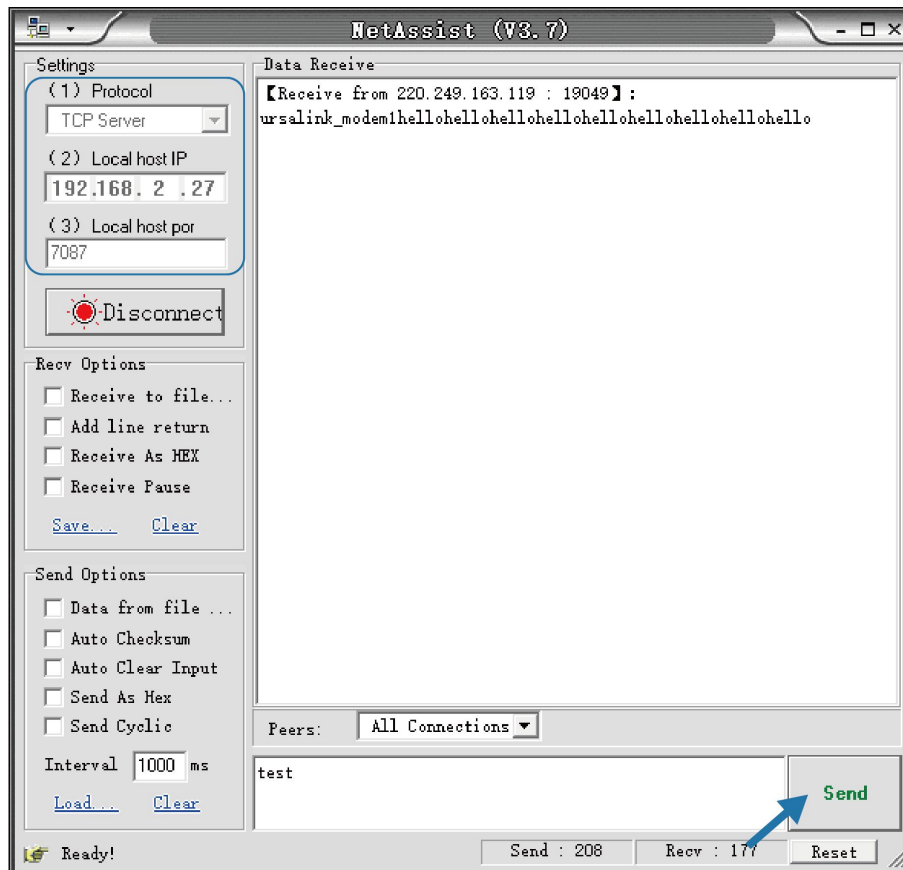

8. After serial communication test is done, you can connect PLC to RS232 port of the UR75 for test.

Related Topic

[Serial Port](#)

5.22 PPTP Application Example

Example

Configure the UR75 as PPTP client to connect to a PPTP server in order to have data transferred securely. Refer to the following topological graph.

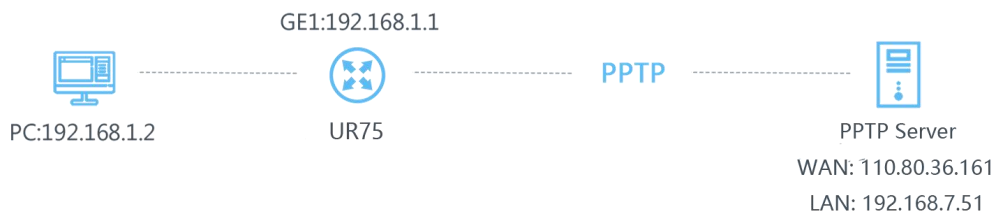

Configuration Steps

1. Go to “Network > VPN > PPTP”, configure PPTP server IP address, username and password provided by PPTP server.

Note: If you want to have all data transferred through VPN tunnel, check “Global Traffic Forwarding” option.



<ul style="list-style-type: none"> Status Network Interface Firewall QoS DHCP DDNS Link Failover Routing <li style="background-color: #0070C0; color: white;">VPN System 	DMVPN	IPsec	GRE	L2TP	PPTP
	Certifications				
	PPTP Settings				
	— PPTP_1				
	Enable <input checked="" type="checkbox"/>				
	Remote IP Address		<input type="text" value="110.87.98.58"/>		
	Username		<input type="text" value="pptpserver"/>		
	Password		<input type="password" value="....."/>		
	Authentication		Auto		
	Global Traffic Forwarding		<input type="checkbox"/>		
Remote Subnet		<input type="text"/>			
Remote Subnet Mask		<input type="text"/>			
Advanced Settings		<input type="checkbox"/>			

If you want to access peer subnet such as 192.168.3.0/24, you need to configure the subnet and mask to add the route.

Remote Subnet	<input type="text" value="192.168.3.0"/>
Remote Subnet Mask	<input type="text" value="255.255.255.0"/>

2. Check “Show Advanced” option, and you will see the advanced settings.

DMVPN	IPsec	GRE	L2TP	PPTP	OpenVPN Client	OpenVPN Server	Certifications
Show Advanced		<input checked="" type="checkbox"/>					
Local IP Address		<input type="text"/>					
Peer IP Address		<input type="text"/>					
Enable NAT		<input checked="" type="checkbox"/>					
Enable MPPE		<input type="checkbox"/>					
Address/Control Compression		<input type="checkbox"/>					
Protocol Field Compression		<input type="checkbox"/>					
Asynmap Value		<input type="text" value="ffffff"/>					
MRU		<input type="text" value="1500"/>					
MTU		<input type="text" value="1500"/>					
Link Detection Interval (s)		<input type="text" value="60"/>					
Max Retries		<input type="text" value="0"/>					
Expert Options		<input type="text"/>					

If the PPTP server requires MPPE encryption, then you need to check “Enable MPPE” option.

Enable MPPE

If the PPTP server assigns fixed tunnel IP to the client, then you can fill in the local tunnel IP and remote tunnel IP, shown as below.

Local IP Address

Peer IP Address

Otherwise PPTP server will assign tunnel IP randomly.

Click “Save” button when you complete all settings, and then the advanced settings will be hidden again. Then click “Apply” button to have the configurations take effect.

3. Go to “Status > VPN” and check PPTP connection status.

PPTP is established as shown below.

Local IP: the client tunnel IP.

Remote IP: the server tunnel IP.

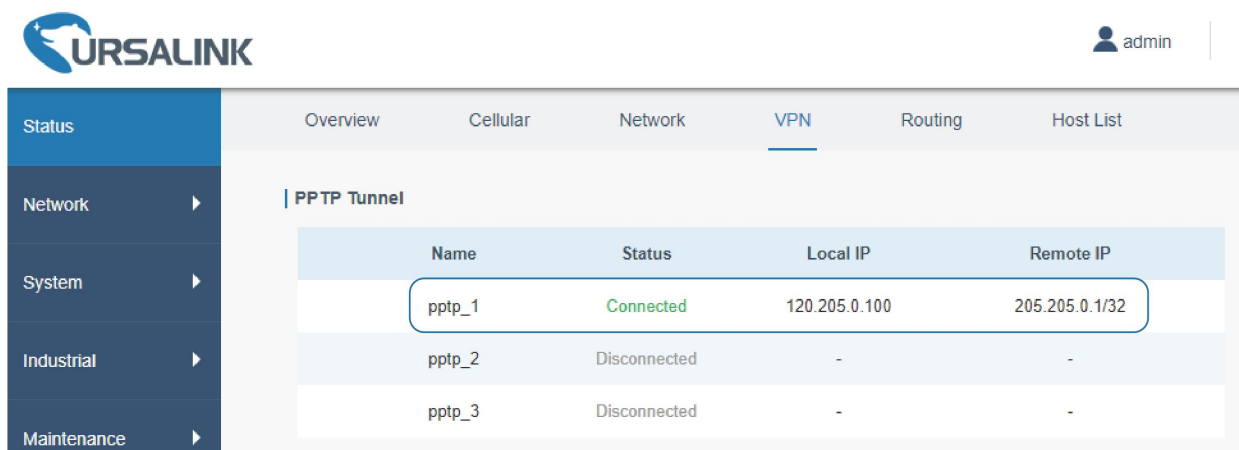

The screenshot shows the URSA LINK interface with the user 'admin' logged in. The 'VPN' tab is selected in the top navigation. A sidebar on the left contains menu items: Status, Network, System, Industrial, and Maintenance. The main content area displays a table titled 'PPTP Tunnel' with the following data:

Name	Status	Local IP	Remote IP
pptp_1	Connected	120.205.0.100	205.205.0.1/32
pptp_2	Disconnected	-	-
pptp_3	Disconnected	-	-

Related Topics

[PPTP Setting](#)

[PPTP Status](#)

[END]