



UR72 & UR75

Industrial Cellular Router

Quick Start Guide



Welcome

Thank you for choosing Ursalink UR72/UR75 industrial cellular router.

This guide describes how to install the UR72/UR75 and how to log in the Web GUI to configure the device. Once you complete the installation, refer to the Ursalink UR72/UR75 User Guide for instructions on how to perform configurations on the device.

Related Documents

This Start Guide only explains the installation of Ursalink UR72 & UR75 router. For more functionality and advanced settings, please refer to the relevant documents as below.

Document	Description
Ursalink UR72/UR75 Datasheet	Datasheet for the Ursalink UR72/UR75 industrial cellular router.
Ursalink UR72/UR75 User Guide	Users could refer to the guide for instruction on how to log in the web GUI, and how to configure all the settings.

The related documents are available on Ursalink website: <http://www.ursalink.com>.

Declaration of Conformity

UR72 & UR75 are in conformity with the essential requirements and other relevant provisions of the CE, FCC, and RoHS.

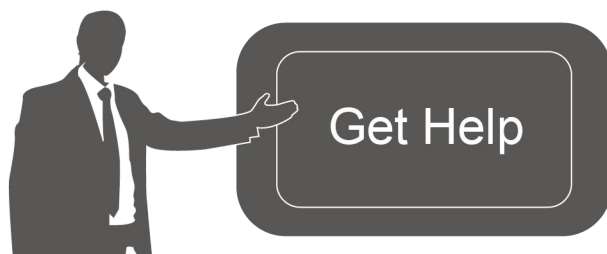

For assistance, please contact
 Ursalink technical support:
 Email: support@ursalink.com
 Tel: 86-592-5023060
 Fax: 86-592-5023065

1. Packing List

Before you begin to install the UR72/UR75 router, please check the package contents to verify that you have received the items below.

1.1 Package Contents



1 × UR72 Router

or

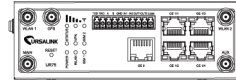

1 × UR75 Router



1 × Ethernet Cable

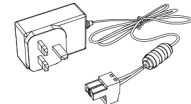

1 × Power Adapter



2 × SIM Card Slots

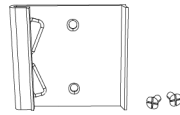

1 × DIN Rail Kit

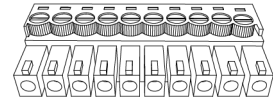

 2 × Magnetic Mount
Cellular Antennas

 1 × 10-Pin Pluggable
Terminal

1 × Warranty Card

 1 × GPS Antenna
(Optional)

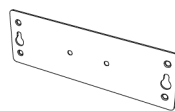
 1 × 2-Pin Pluggable
Terminal (Optional)

 2 × Stubby Cellular
Antennas (Optional)

 2 × Stubby Wi-Fi
Antennas (Optional)

 1 × Wall Mounting Bracket
(Optional)



If any of the above items is missing or damaged, please contact your Ursalink sales representative.

2. Hardware Introduction

2.1 Overview

A. Front Panel

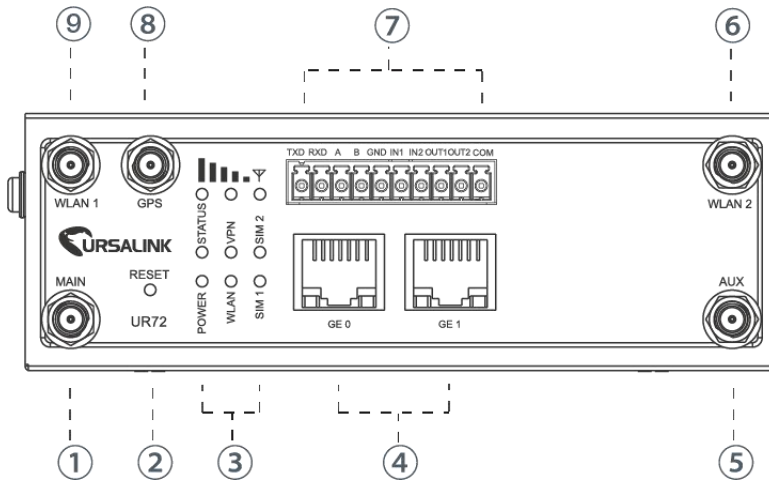
UR72 Front Panel



- ① Main Cellular Antenna Connector
- ② Reset Button
- ③ LED Indicator Area
 - POWER: Power Indicator
 - STATUS: Status Indicator
 - WLAN: Wi-Fi Indicator
 - VPN: VPN Indicator
 - SIM 1: SIM 1 Status Indicator
 - SIM 2: SIM 2 Status Indicator
 - 📶: Signal Strength Indicator
- ④ Ethernet Port Indicator
 - Orange for data transmission;
 - Green for network rate
- ⑤ AUX Cellular Antenna
- ⑥ WLAN 2: Wi-Fi Antenna Connector 2
- ⑦ Serial Port & I/O
- ⑧ GPS: GPS Antenna Connector
- ⑨ WLAN 1: Wi-Fi Antenna Connector 1

UR75 Front Panel

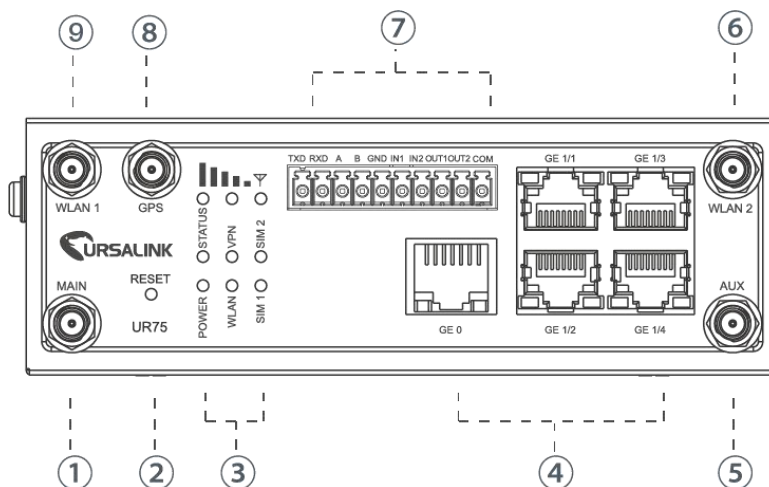

- ① Main Cellular Antenna Connector
- ② Reset Button
- ③ LED Indicator Area
 - POWER: Power Indicator
 - STATUS: Status Indicator
 - WLAN: Wi-Fi Indicator
 - VPN: VPN Indicator
 - SIM 1: SIM 1 Status Indicator
 - SIM 2: SIM 2 Status Indicator
 - 📶: Signal Strength Indicator
- ④ Ethernet Port Indicator
 - Orange for data transmission;
 - Green for network rate
- ⑤ AUX Cellular Antenna
- ⑥ WLAN 2: Wi-Fi Antenna Connector 2
- ⑦ Serial Port & I/O
- ⑧ GPS: GPS Antenna Connector
- ⑨ WLAN 1: Wi-Fi Antenna Connector 1

B. Left Side Panel

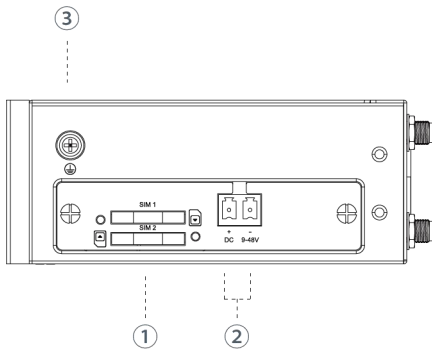

- ① SIM Card Slot
- ② Power Connector
- ③ Grounding Stud

2.2 Dimensions (mm)

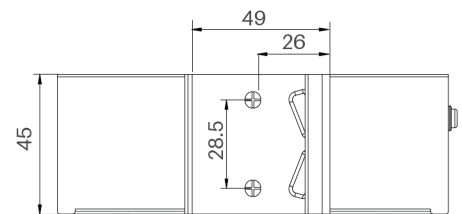
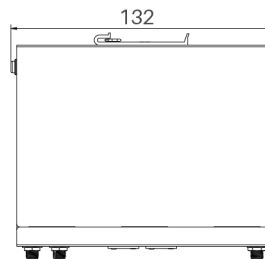
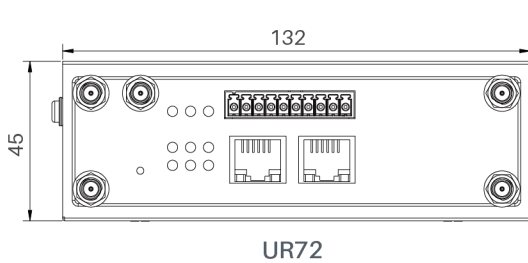

UR72

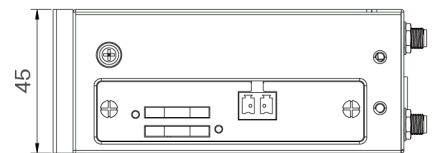
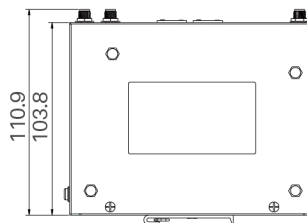
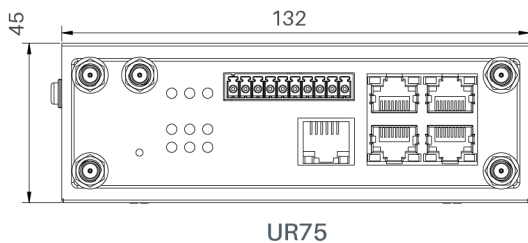

UR75

2.3 Pinouts

TXD RXD A B GND IN1 IN2 OUT1 OUT2 COM

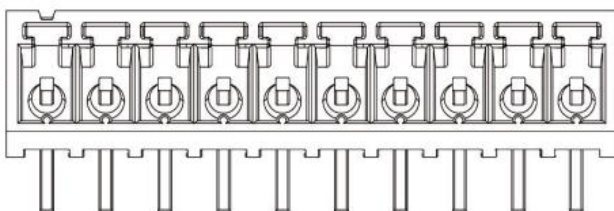

PIN	RS232	RS485	DI	DO	Description
1	TXD	---	---	---	Transmit Data
2	RXD	---	---	---	Receive Data
3	---	A	---	---	Data +
4	---	B	---	---	Data -
5	GND	---	GND	---	Ground
6	---	---	IN1	---	Digital Input1
7	---	---	IN2	---	Digital Input2
8	---	---	---	OUT1	Digital Output1
9	---	---	---	OUT2	Digital Output2
10	---	---	---	COM	Common Ground

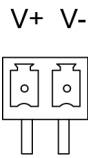

PIN	Description
11	Positive
12	Negative

2.4 LED Indicators

LED	Indication	Status	Description	
POWER	Power Status	On	The power is switched on	
		Off	The power is switched off	
STATUS	System Status	Green Light	Static: Start-up Blinking slowly: the system is running properly	
		Red Light	The system goes wrong	
VPN	VPN Status	Green Light	VPN is connected	
		Off	VPN is disconnected	
WLAN (Wi-Fi)	WLAN Status	Green Light	Static: Wi-Fi is enabled Blinking slowly: sending or receiving data via Wi-Fi	
		Off	Wi-Fi is disabled	
SIM1/SIM2	SIM Card Status	Off	SIM1 or SIM2 is registering or fails to register (or there are no SIM cards inserted)	
		Green Light	Blinking slowly: SIM1 or SIM2 has been registered and is ready for dial-up	
			Blinking rapidly: SIM1 or SIM2 has been registered and is dialing up now	
Signal Strength	Signal 1/2/3	Green Light	Static: SIM1 or SIM2 has been registered and dialed up successfully	
			Off	No signal
			Static/Off/Off: weak signals with 1-10 ASU (please check if the antenna is installed correctly, or move the antenna to a suitable location to get better signal)	
			Static/Static/Off: normal signals with 11-20 ASU (average signal strength)	
			Static/Static/Static: strong signals with 21-31 ASU (signal is good)	

2.5 Reset Button

Function	Description	
	STATUS LED	Action
Reboot	Blinking	Press and hold the reset button for about 5-15 seconds.
	Static Green	Release the button and wait for system to reboot.
Reset	Blinking	Press and hold the reset button for more than 15 seconds.
	Static Green → Rapidly Blinking	Release the button and wait.
	Off → Blinking	The router is now reset to factory defaults.

2.6 Ethernet Port Indicator

Indicator	Status	Description
Link Indicator (Orange)	On	Connected
	Blinking	Transmitting data
	Off	Disconnected
Rate Indicator (Green)	On	1000 Mbps mode
	Off	100 Mbps mode

3. Hardware Installation

Environmental Requirements

- Power Input: 9-48 VDC
- Power Consumption: Typical 3.3W (Max 5.8 W) for UR72
 Typical 4.0 W (Max 6.7 W) for UR75
- Operating Temperature: -40°C to 70°C (-40°F -158°F)
- Relative Humidity: 0% to 95% (non-condensing) at 25°C/77°F

3.1 SIM Card/Micro SD Card/SSD Installation

3.1.1 SIM Card Installation

A. Push the yellow button on the left panel of the slot router, and then you will see the SIM card slot popping out directly.

B. Put SIM card onto the slot then insert the back into the hole.

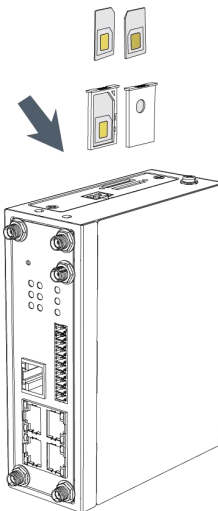
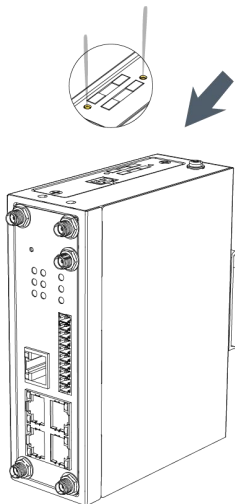

3.1.2 Micro SD Card Installation

A. Unscrew the cover on the left panel of the router and then take it off.

B. Insert Micro SD card.

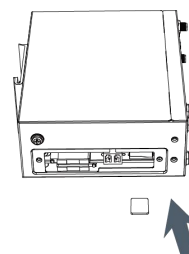
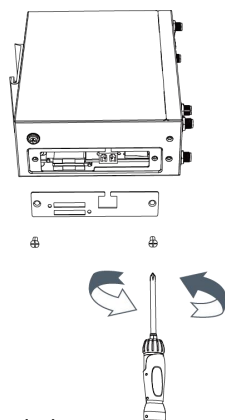

C. Close the cover and screw it back to the router.

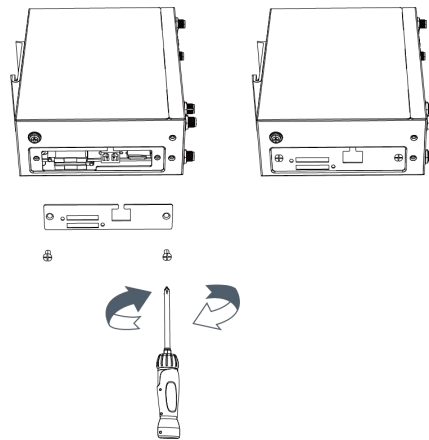

3.1.3 SSD Installation

! Before installing SSD, please turn off the power.

A. Unscrew the enclosure, and then remove the cover.

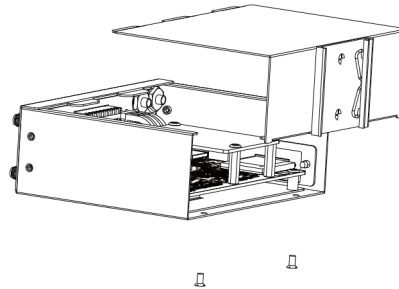

B. Unscrew the main-board, find the interface on the rear side of the main-board and then insert SSD.

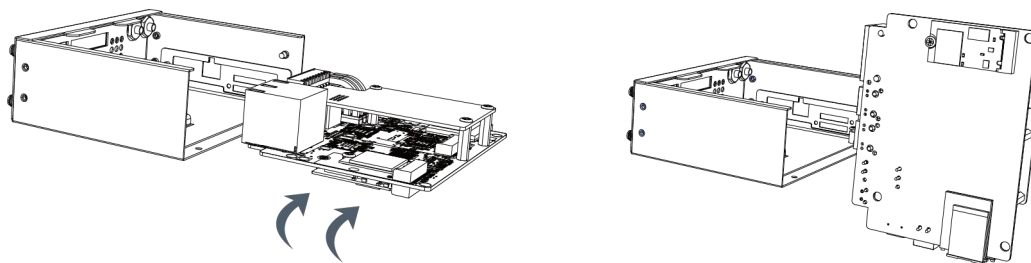

C. Screw the main-board on the cabinet and close the cover.

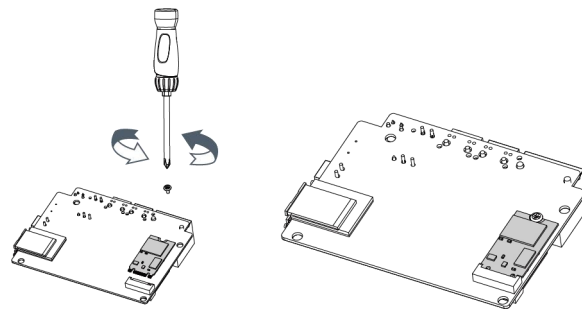

3.2 Antenna Installation

Rotate the antenna into the antenna connector accordingly.

The external antenna should be installed vertically always on a site with a good cellular signal.

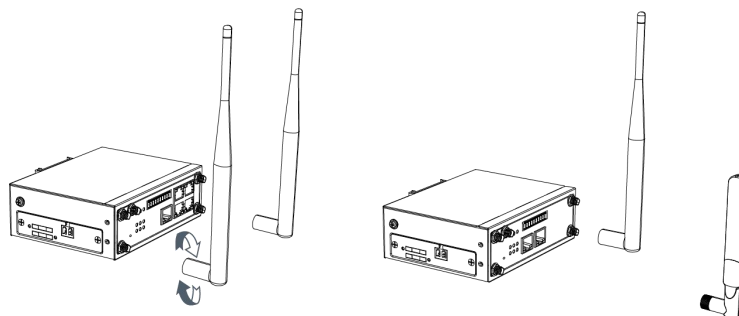

3.3 Connect the Router to a Computer



Please connect PC to any port among GE 1/1-GE 1/4 of UR75 router, or to GE 1 of UR72 router directly.

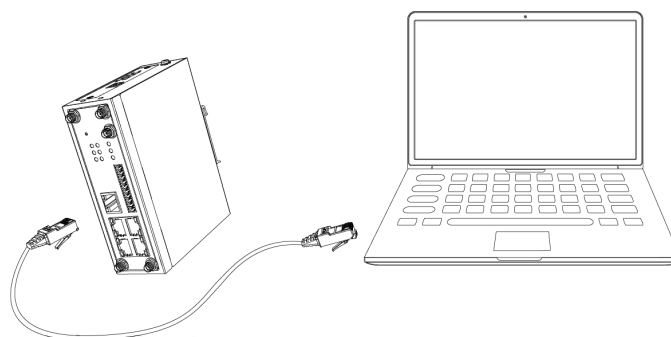

3.4 Mount the Router

3.4 Mount the Router

The router can be placed on a desktop or mounted to a wall or a DIN rail.

3.4.1 Wall Mounting (Measured in mm)

Use 2 pcs of M3 × 6 flat head Phillips screws to fix the wall mounting kit to the router, and then use 2 pcs of M3 drywall screws to mount the router associated with the wall mounting kit on the wall.

! Recommended torque for mounting is 1.0 N·m, and the maximum allowed is 1.2 N·m.

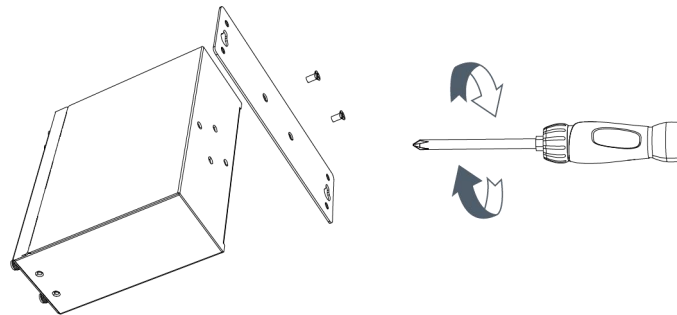

3.4.2 DIN Rail Mounting (Measured in mm)

Use 2 pcs of M3 × 6 flat head Phillips screws to fix the DIN rail to the router, and then hang the DIN rail on the mounting bracket. It is necessary to choose a standard bracket.

! Recommended torque for mounting is 1.0 N·m, and the maximum allowed is 1.2 N·m.

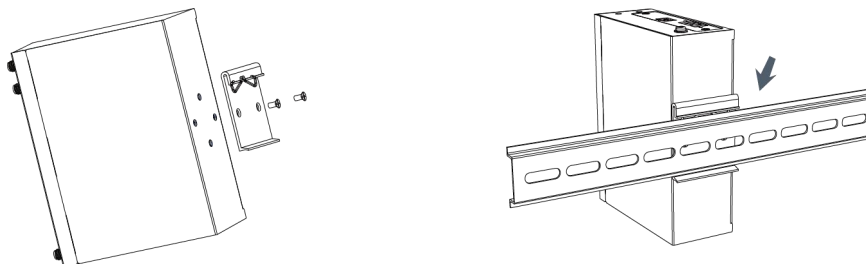

3.5 Power Supply Installation

- A. Take out the terminal from the router and unscrew the bolt on terminal.
- B. Screw down the bolt after inserting power cable into the terminal.

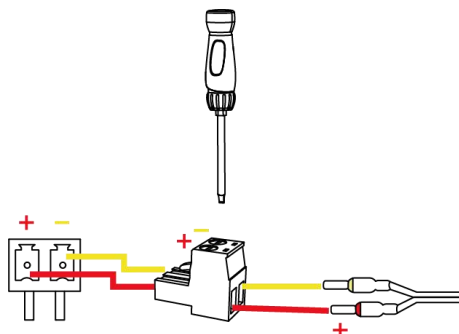

Connecting the Power Cable

Color	Polarity
Red	+
Yellow	-

! If you insert wires into the reverse holes, the router will not start and you must switch the wires into the correct holes.

3.6 Protective Grounding Installation

- A. Remove the grounding nut.
- B. Connect the grounding ring of the cabinet's grounding wire onto the grounding stud and screw up the grounding nut.

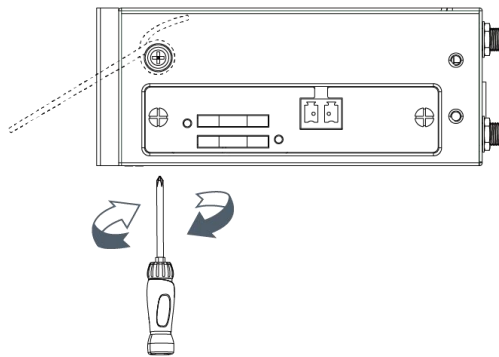

The router must be grounded when deployed. According to operating environment, the ground wire should be connected with grounding stud of router.

Getting Started

4. PC Configuration for Web GUI Accessing to Router

Please connect PC to any port among GE 1/1-GE 1/4 of UR75 router, or to GE 1 of UR72 router directly. PC can obtain an IP address, or you can configure a static IP address manually. The following steps are based on Windows 10 operating system for your reference.

(Note: As remote access is disabled by default, you can't access to the router's Web GUI if you connect PC to GE 0 of the router. But it will function properly if you enable it on the Web GUI.)

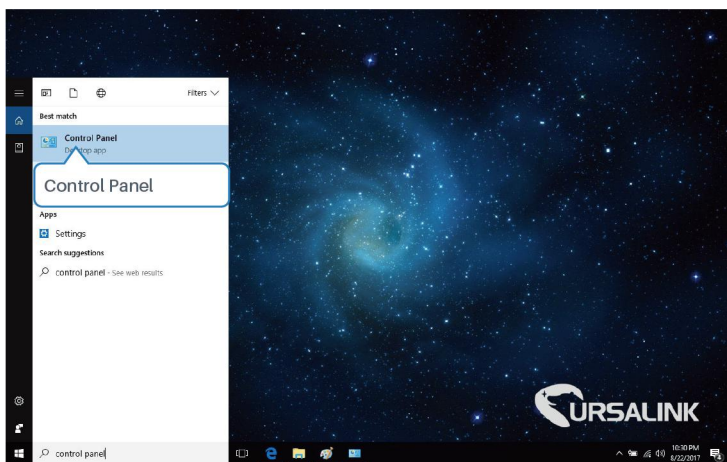

① Click "Search Box" to search "Control Panel" on the Windows 10 taskbar.

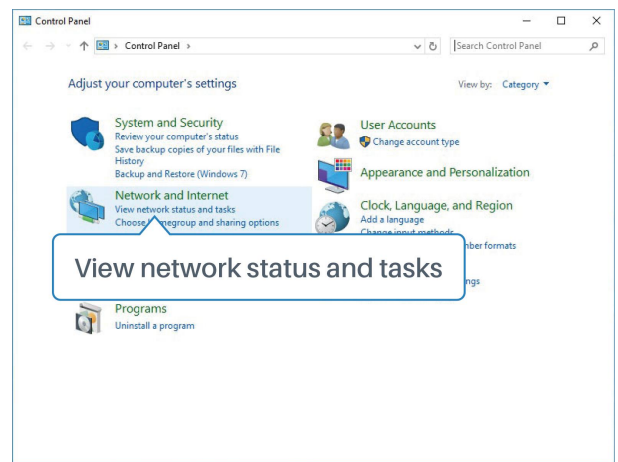

② Click "Control Panel" to open it, and then click "View network status and tasks".

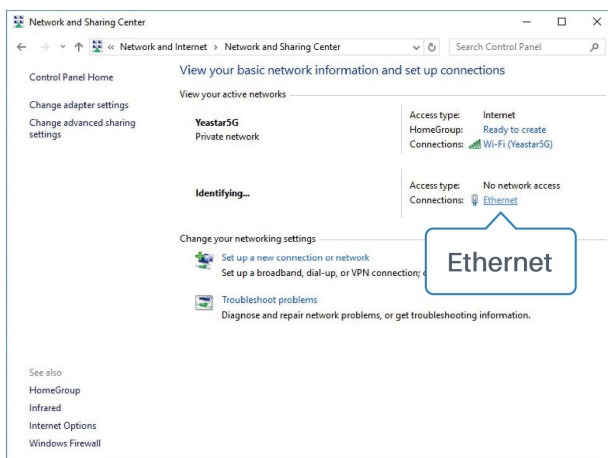

③ Click "Ethernet" (May have different names).

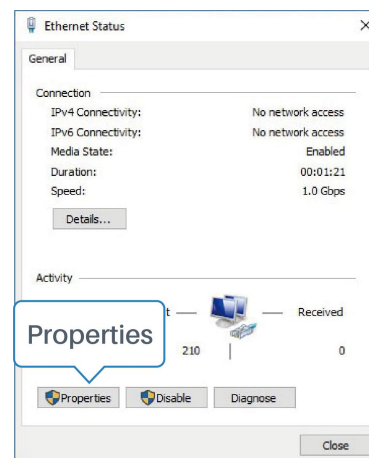

④ Click "Properties".

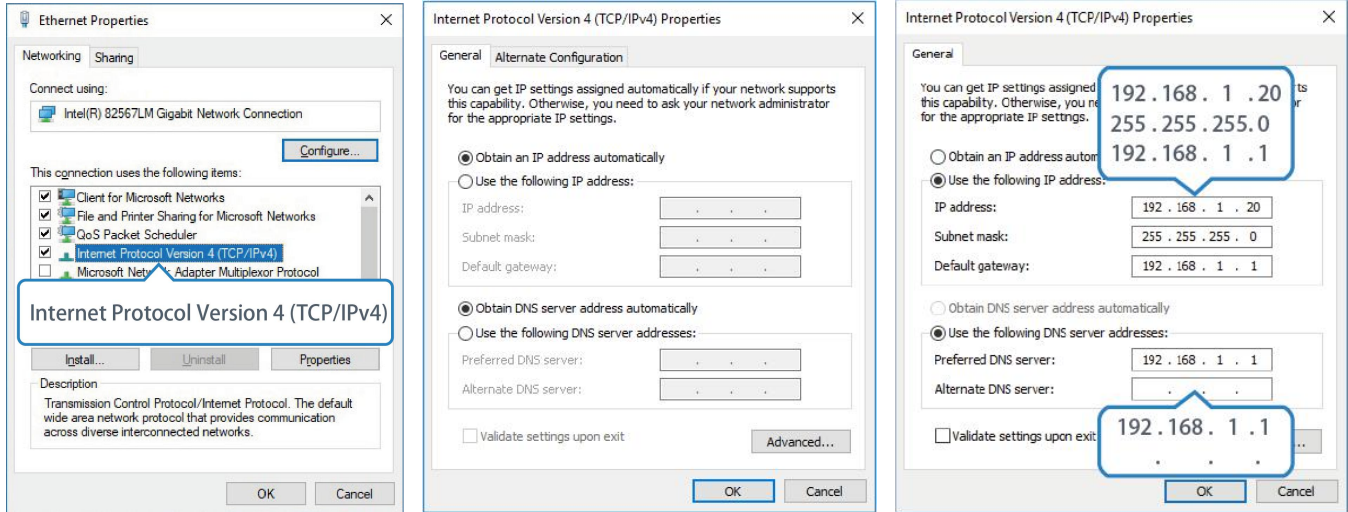

⑤ Double Click “Internet Protocol Version 4 (TCP/IPv4)” to configure IP address and DNS server.

⑥ Method 1: click “Obtain an IP address automatically”;

Method 2: click “Use the following IP address” to assign a static IP manually within the same subnet of the router.

(Note: Remember to click “OK” to finish configuration.)

5. Access to Web GUI of Router for Cellular Connection

This chapter explains how to log in UR72/UR75 router's Web GUI, and connect the router to cellular network.

Ursalink router provides Web-based configuration interface for management. If this is the first time you configure the router, please use the default settings below:

IP Address: **192.168.1.1**

Username: **admin**

Password: **password**

5.1 To Log in the Router

 **Make sure your PC is connected to the same network as the router as per [Section 4](#).**

A. Start a Web browser on your PC (Chrome and IE are recommended), type in the IP address, and press Enter on your keyboard.

B. Enter the username and password, click "Login".

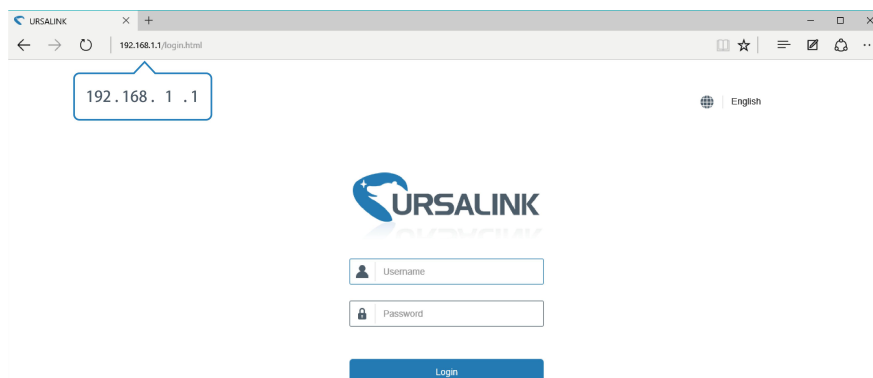

 **If you enter the username or password incorrectly more than 5 times, the login page will be locked for 10 minutes.**

C. When you log in with the default username and password, you will be asked to modify the password. It's suggested that you change the password for the sake of security. Click "Cancel" button if you want to modify it later.

Change Password ✕

Old Password

New Password

Confirm New Password

D. After you log in the Web GUI, you can view system information and perform configuration on the router.

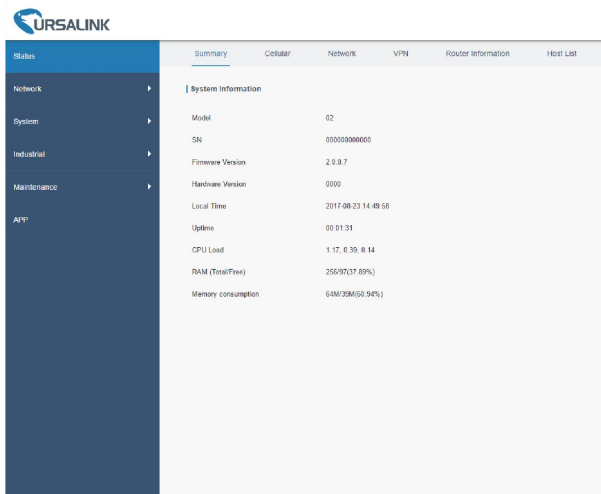

5.2 Configure the Cellular Connection

Take inserting SIM card into SIM1 slot as an example; please refer to the following detailed operations.

- Click "Network" → "Interface" → "Cellular" → "Cellular Setting" to configure the cellular info.
- Enable SIM1.
- Choose relevant network type. "Auto", "4G First", "4G Only", "3G First", "3G Only", "2G First" and "2G Only" are optional.
- Click "Save" and "Apply" for configuration to take effect.

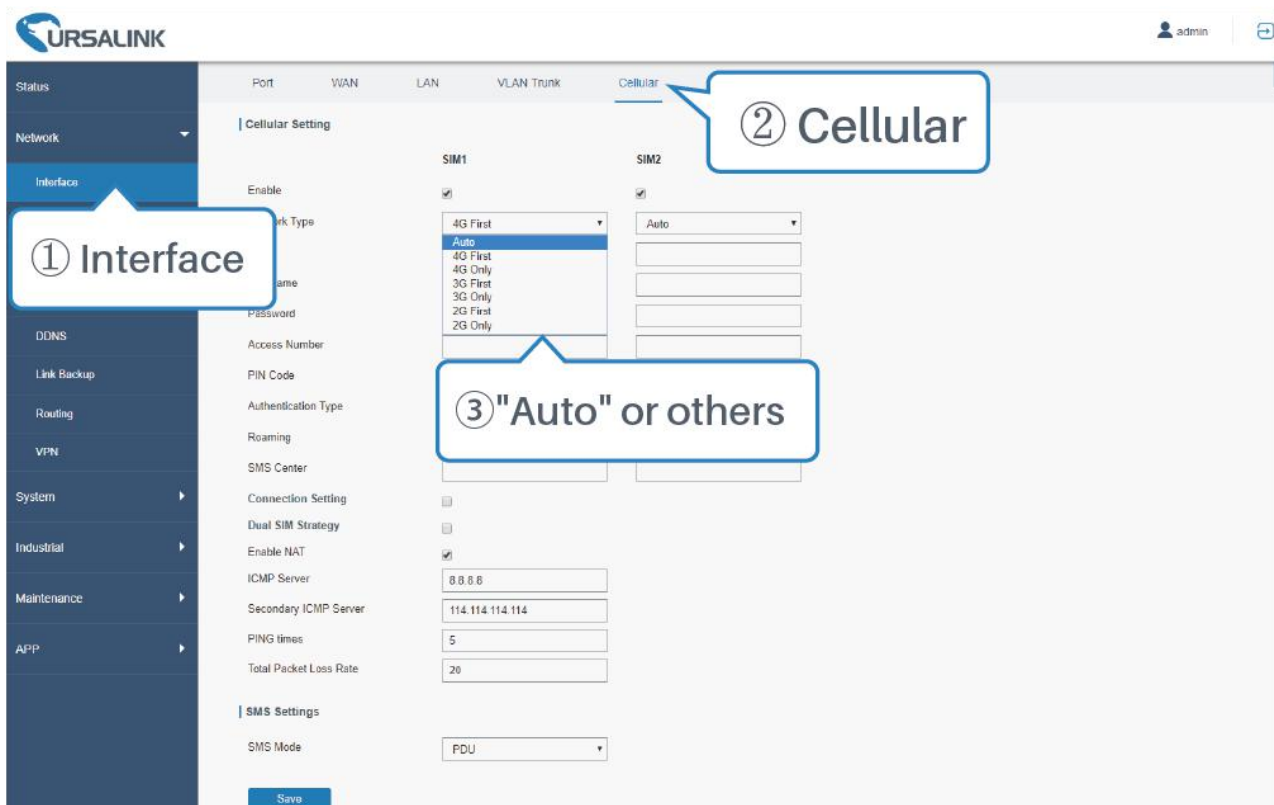

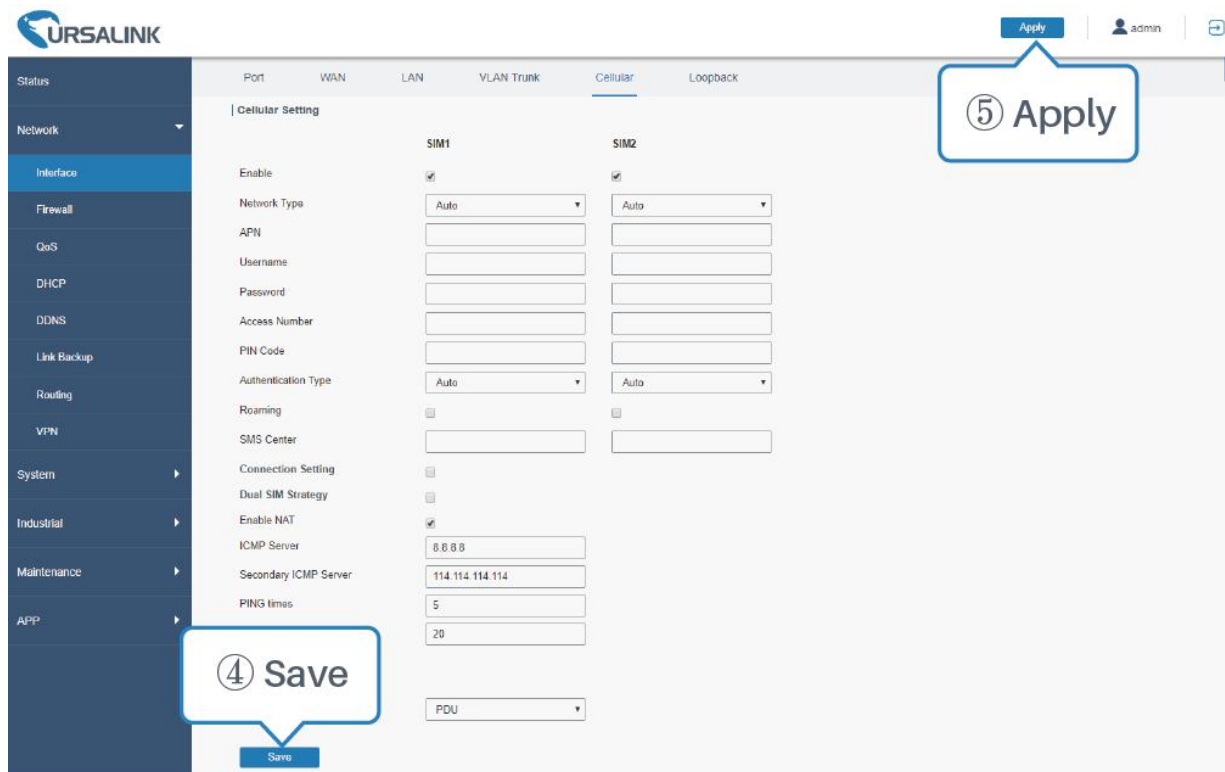

If you select “Auto”, the router will obtain ISP information from SIM card to set APN, Username, and Password automatically. This option will only be taken effect when the SIM card is issued from a well-known ISP.

If you select “4G First” or “4G Only”, you can click “Save” to finish the configuration directly.

If you select “3G First”, “3G Only”, “2G First” or “2G Only”, you should manually configure APN, Username, Password, and Access Number.

UR72 & UR75 routers have two cellular interfaces, named SIM1 & SIM2. Only one cellular interface is active at one time. If both cellular interfaces are enabled, SIM1 interface takes precedence by default.

5.3 Check the Cellular Connection Status

5.3.1 Check the Cellular Connection Status by Web GUI of Router

Click “Status” → “Cellular” to view the status of the cellular connection. If it shows “Connected”, it means SIM1 has dialed up successfully.

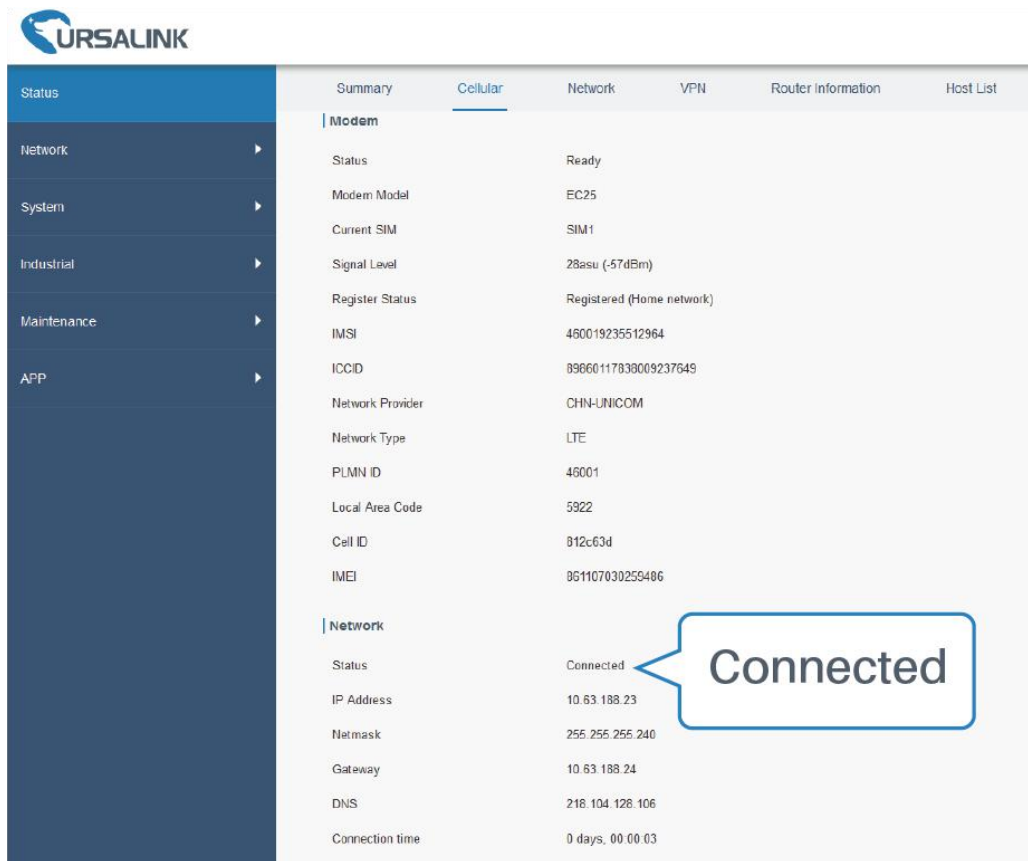

	Summary	Cellular	Network	VPN	Router Information	Host List
Modem						
Status		Ready				
Modem Model		EC25				
Current SIM		SIM1				
Signal Level		28asu (-57dBm)				
Register Status		Registered (Home network)				
IMSI		460019235512964				
ICCID		89660117839009237649				
Network Provider		CHN-UNICOM				
Network Type		LTE				
PLMN ID		46001				
Local Area Code		5922				
Cell ID		812c63d				
IMEI		861107030259486				
Network						
Status		Connected				
IP Address		10.83.188.23				
Netmask		255.255.255.240				
Gateway		10.83.188.24				
DNS		218.104.128.106				
Connection time		0 days, 00:00:03				

5.3.2 Check the Cellular Connection Status by Hardware

On the other hand, you can check the status of SIM1 indicator. If it keeps on green light statically, it means SIM1 has dialed up successfully.

5.4 Check out if Network Works Properly by Browser on PC

Open your preferred browser on PC, then type any available web address into address bar and see if it is able to visit Internet via UR72/UR75 router.

[END]