

# HELI-3

## ANTENNAS | HELI-3 SERIES

# CIRCULAR POLARISED, DIRECTIONAL MINE/TUNNEL ANTENNA

Wi-Fi; 2400 - 2500 MHz, 17.5 dBi

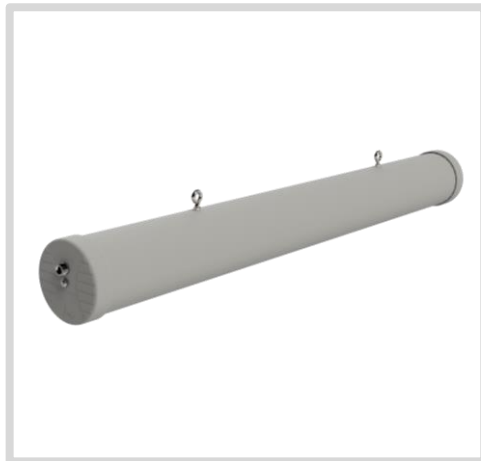

2400-2500 MHz	17.5 dBi	Increase x Mb/s	Uni-Directional	Machine to Machine	2.4 - 2.5 GHz
IP 65	-20°C to +70°C	Fire Resistant			

- Circular polarised HELI antenna provides enhanced signal propagation and connection stability within a tunnel
- Uni-directional – radiates in one direction in a tunnel
- Covers Wi-Fi band from 2400 – 2500 MHz
- Careful mechanical design provides ruggedness, water and dust resistance (IP 65)
- Ideal for Mining & Tunnel M2M and Wi-Fi deployments
- Easy installation with eyebolts for ceiling use and ground plane

APPLICATION AREAS

- Mining
- Tunnelling
- MASC
- Urban

## Product Overview

The HELI-3 is a high gain, directional antenna which complements our Wi-Fi MinePoynt tunnel and mine antennas. The combination of MinePoynt beam antennas for long distance Thru-tunnel links with this directional antenna, exploits Poynting's fifteen years' experience in designing and manufacturing antennas for underground mining data networks. The tunnel antenna is the ideal antenna for 2.4 - 2.5 GHz wireless applications in tunnels. In tests, both the data rate and range achieved with this antenna was greater than obtained when using linearly polarized panel antennas of the same gain. The hardy construction of this antenna makes it ideal for the mining environment. HELI-3 is a uni-directional antenna whilst the closely related HELI-8 is a bi-directional antenna. An intrinsically safe version of this antenna is available with code HELI-3-IS. The HELI-3 gives you a low-cost network infrastructure for current voice and data needs in mines and tunnels.

## Features

- Uni-directional antenna
- High gain over the 2.4 GHz Wi-Fi band
- Improved performance due to circular polarisation
- Ideal for mining and tunnelling applications
- Versatile installation mounting options

## Application Areas

- Supplementing fibre/cable networks by providing wireless "Hotspots" to areas to enhance mobility or extend networks to inaccessible areas such as mines and tunnels
- Underground telemetry
- Creation of complete in tunnel/mine wide data networks and/or internet connectivity
- Seamless connection to personnel using VOIP phones, smart devices and tablets
- M2M applications





## Frequency Bands

The HELI-3 is a Wi-Fi / ISM antenna that works from 2400 – 2500 MHz

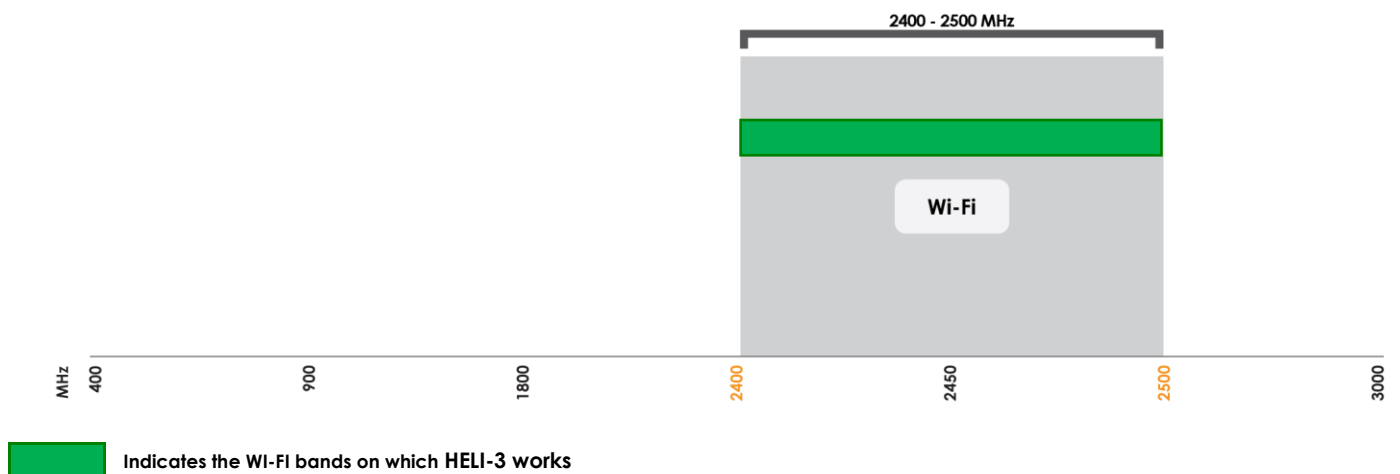

## Antenna Overview

	
Ports	1
SISO / MIMO	SISO
Frequency Bands	2400 - 2500 MHz
Peak Gain	17.5 dBi
Coax Cable Type	N/A
Coax Cable Length	N/A
Connector Type	N-Type(F)

\*The connector is factory mounted to the antenna

## Electrical Specifications

Frequency bands:	2400-2500 MHz
Gain (Max)	17.5 dBi
VSWR:	<1.3:1
Feed power handling:	30 W
Input impedance:	50 Ohm (nominal)
Polarisation:	Left-Hand Circular
DC short:	N/A

## Product Box Contents

Antenna:	A-HELI-0003
Mounting bracket:	Two 6mm eyebolts for ceiling mount

## Ordering Information

Commercial name:	HELI-3
Order product code:	A-HELI-0003
EAN number:	0707273468727

## Mechanical Specifications

Product dimensions	1040 mm x 145 mm x 120 mm
Packaged dimensions:	1060 mm x 160 mm x 160 mm
Weight:	2.35 kg
Packaged weight:	2.6 kg
Radome material:	PVC
Radome colour:	PANTONE 429C RAL 7038
Mounting Type:	Ceiling Mount using the two 6mm eyebolts provided

## Environmental Specifications, Certification & Approvals

Wind Survival:	<120 km/h
Temperature Range (Operating):	-40°C to +70°C
Environmental Conditions:	Outdoor/Indoor
Water ingress protection ratio/standard:	IP 65
Salt Spray:	MIL-STD 810F /ASTM B117
Operating Relative Humidity:	Up to 98%
Storage Humidity:	5% to 95% - non-condensing
Storage Temperature:	-20°C to +70°C
Enclosure Flammability Rating:	UL 94-HB
Impact resistance:	IK 08
Product Safety & Environmental:	Complies with CE and RoHS standards



## Antenna Performance Plots

VSWR

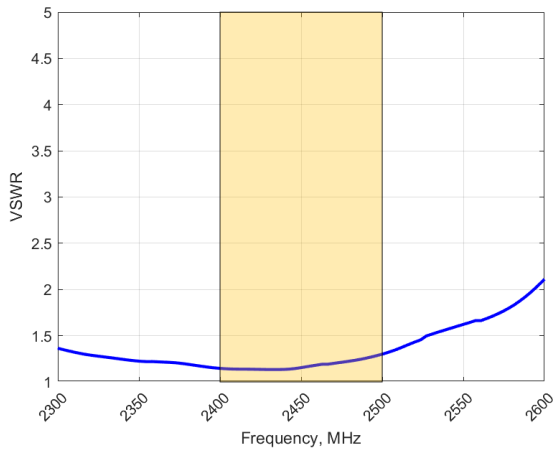

GAIN (EXCLUDING CABLE LOSS)

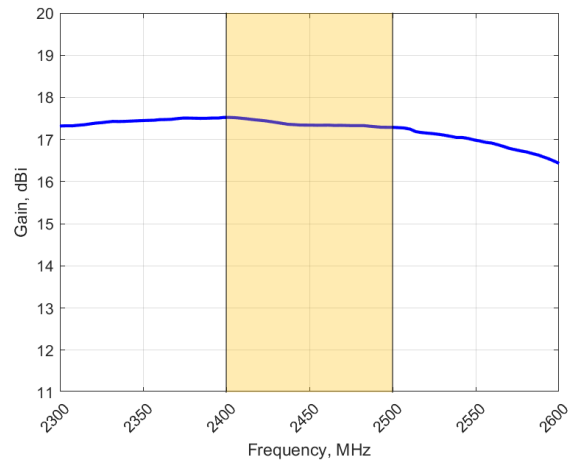

### Voltage Standing Wave Ratio (VSWR)

VSWR is a measure of how efficiently radio-frequency power is transmitted from a power source, through a transmission line, into a load. In an ideal system, 100% of the energy is transmitted which corresponds to a VSWR of 1:1.

The HELI-3 delivers superior performance across all bands with a VSWR of <math><1.3:1</math> or better across 90% of the bands.

### Gain\* in dBi

17.5 dBi is the peak gain across all bands from 2400 – 2500 MHz

Gain @ 2400 – 2500 MHz:

17.5 dBi

*\*Antenna gain measured with polarisation aligned standard antenna*

## Technical Drawings

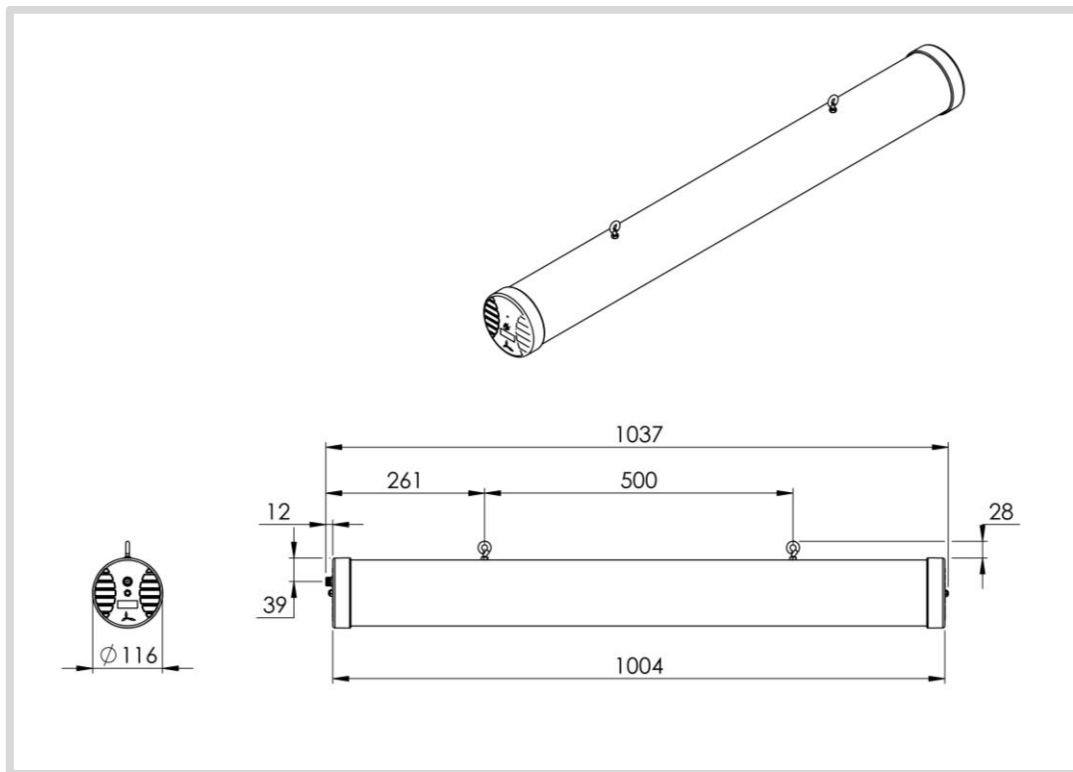

## Radiation Patterns

Azimuth & Elevation: 2400 – 2500 MHz

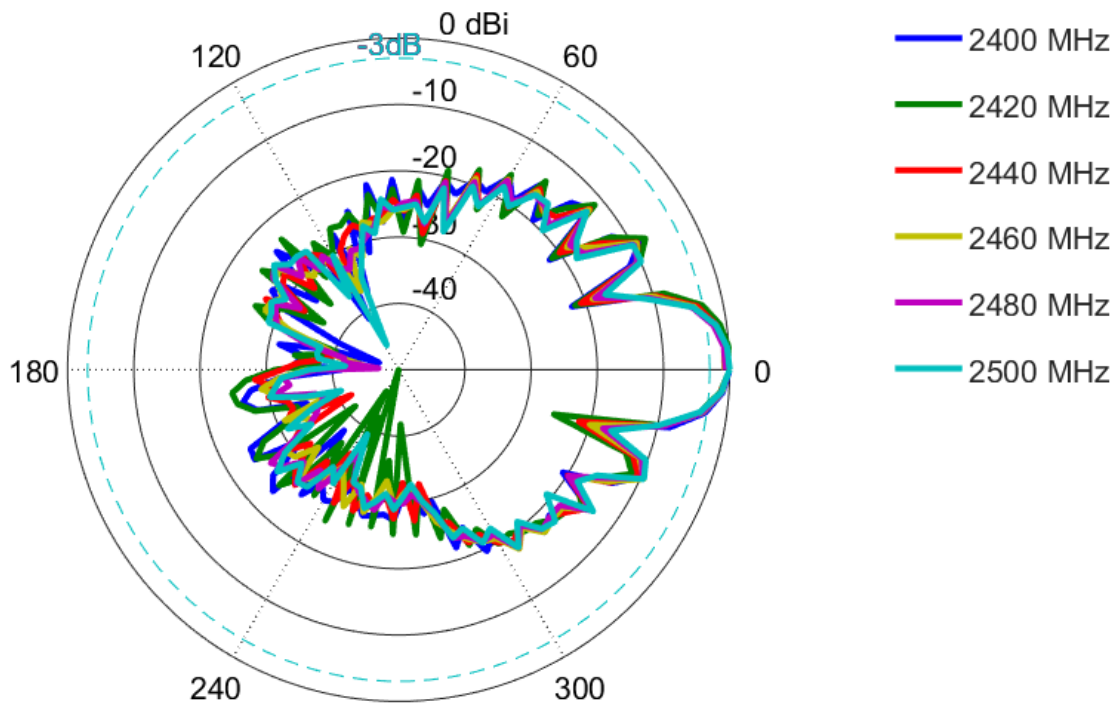

## Additional Accessories

Extension Cables: Up to 15m HDF 195 (extension)

See accessories technical specifications on [www.poynting.tech](http://www.poynting.tech)

## Contact Poynting

### Poynting Antennas (Pty) Ltd - Head Office

Unit 4, N1 Industrial Park  
Landmarks Avenue,  
Samrand, 0157  
South Africa

**Phone:** +27 (0) 12 657 0050

**E-mail:** sales@poynting.co.za

### Poynting Europe

Regus Business Center Neue Messe Riem  
Kronstadter Straße 4  
81677 München  
Germany

**Phone:** +49 89 208026538

**E-mail:** sales-europe@poynting.tech